



**Profiles of rubber, sponge rubber,  
silicone, foam silicone**

D-64579 Gernsheim - Germany

Otto-Hahn-Straße 12

Telefon +49 (0) 62 58 / 932250

Telefax +49 (0) 62 58 / 4997

e-mail: [schild@gummi-plast.de](mailto:schild@gummi-plast.de)

internet: <http://www.gummi-plast.de>

## PROFILE List

### Part 4

profile no. TU1-1046 to AN 1504

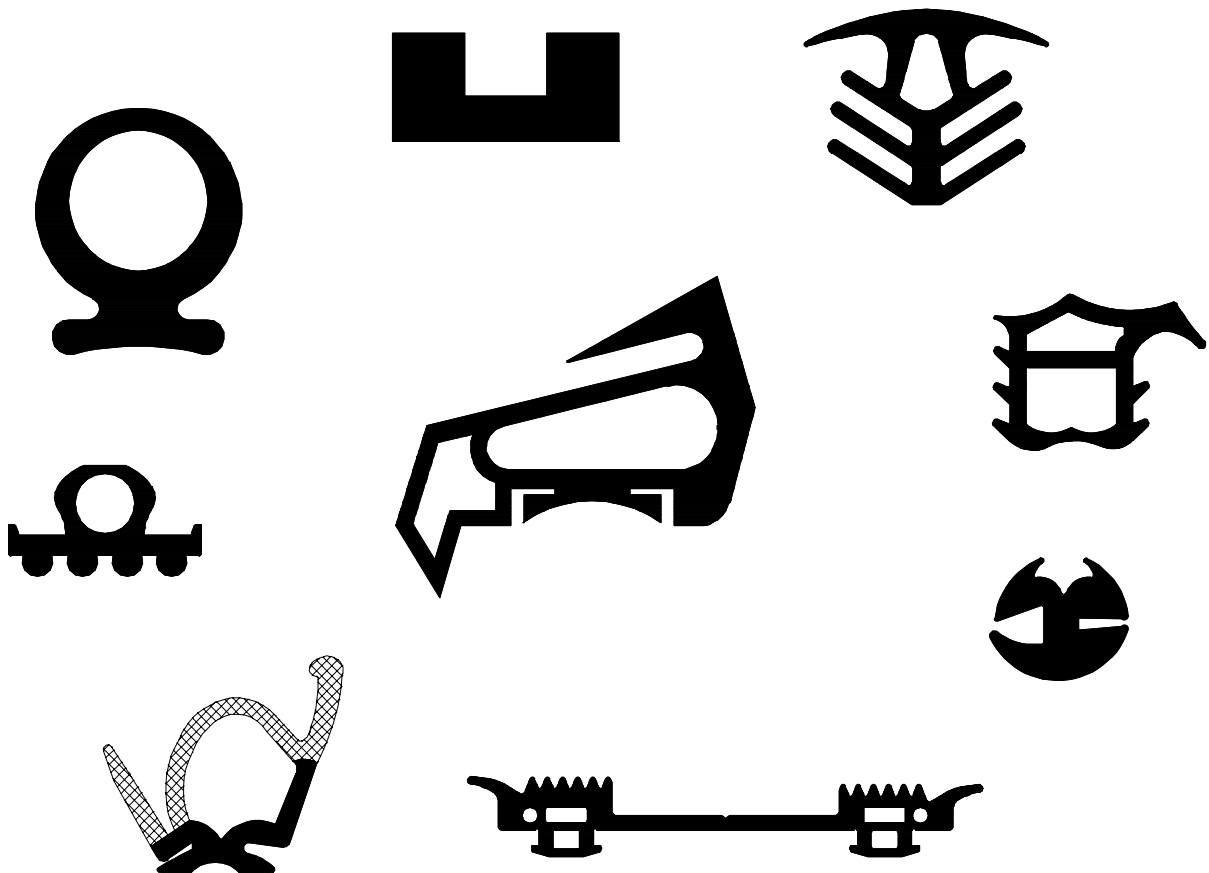

## Important informations!

With this profile list we present to you a selection from our wide range assortment. The catalog informs you about kind and size of the profiles, which we manufacture in the context of our production programme.

We want like to point the existence of costumer protection for some profiles out to you.

Naturally we manufacture also your profiles from solid rubber, sponge rubber, solid silicone, foam silicone and soft PVC, after drawing or sample.

The abbreviations in front of the profile numbers stand for:

AF	= General window sealing profiles
AN	= Frame sealing profiles
AU	= Buffer profiles
F	= Facade profiles
FA	= Joint cover profiles
FN	= Flag (note) profiles
FR	= Filler profiles
FT	= Moulded parts
FU	= U-profiles for windows
GIR	= Solid rubber round section cords
GIV	= Solid rubber square section cords
H	= H-profiles
HF	= Profiles for wooden windows
HR	= Semiround profiles
K	= Refrigerator profiles
KL	= Clamping profiles
KS	= Wedge and plug profiles
MD	= Centre sealing profiles
RI	= Groove profiles
RT	= Roller-shutter and finger-protection profiles
S	= Other profiles
SC	= Tube profiles
SE	= Clip profiles
SL	= Screen strip profiles
T	= T-profiles
TR	= Trapezoidal profiles
TU1-	= Technical-U-profiles
VP	= Glazing profiles
WI	= Angle profiles
Z1-	= Door frame profiles

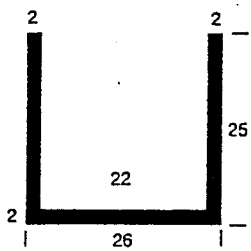

TU1-1046

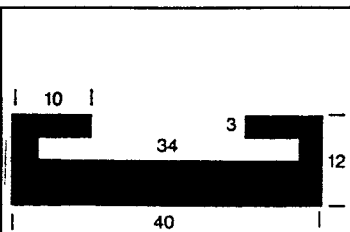

SE1047

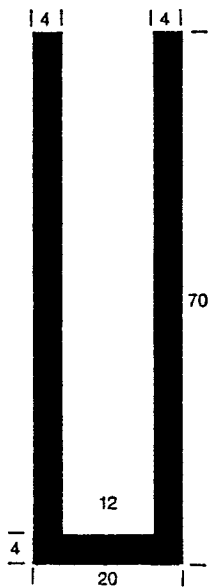

TU1-1048

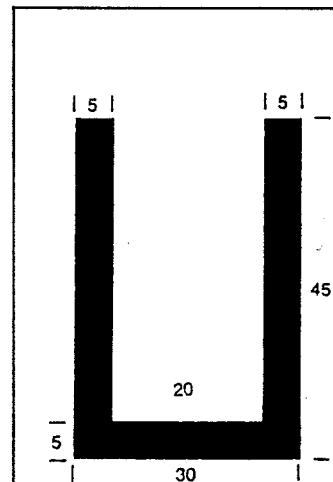

TU1-1049

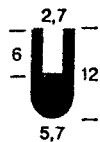

TU1-1050



TU1-1051

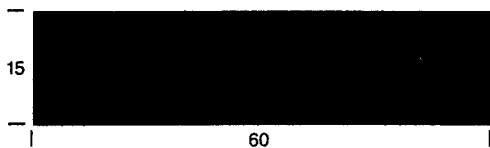

GIV1052

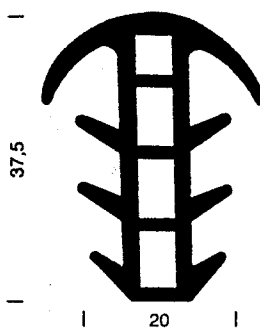

FA1053

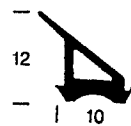

S1054



S1055



S1056

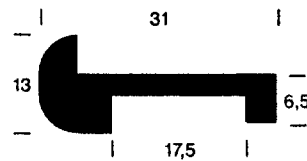

S1057

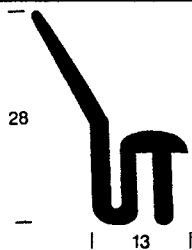

S1058

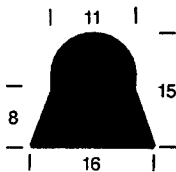

S1059



S1060



S1061



S1062

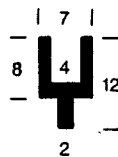

S1063

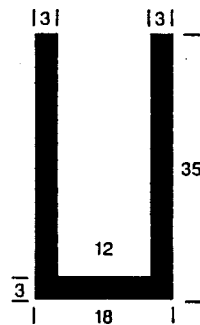

TU1-1064

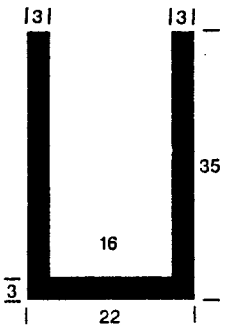

TU1-1065

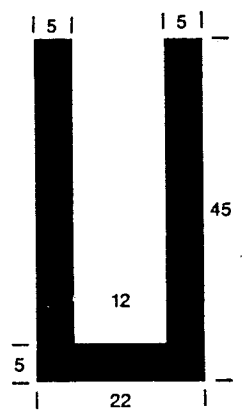

TU1-1066

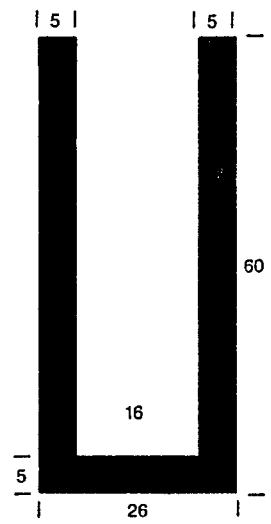

TU1-1067

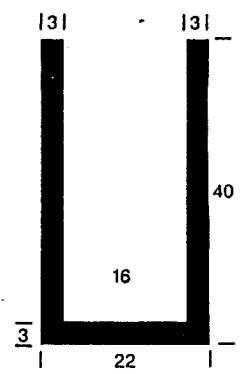

TU1-1068

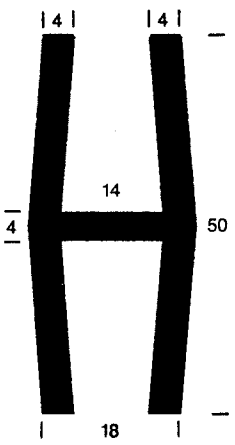

H1069

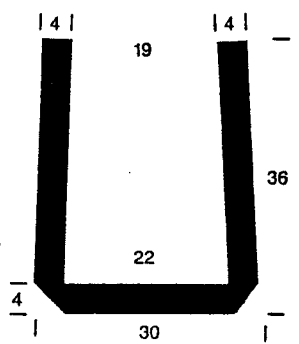

TU1-1070

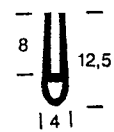

TU1-1071

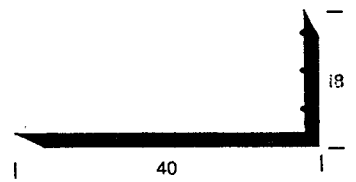

WI1072

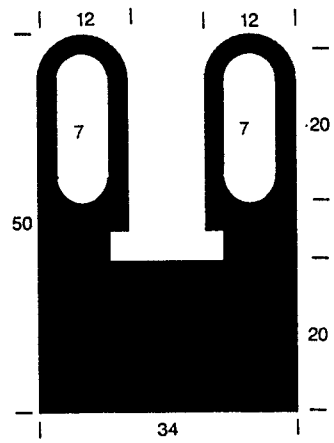

S1073

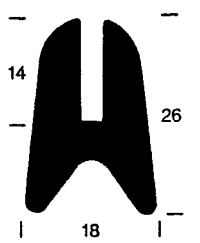

TU1-1074

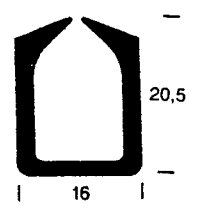

TU1-1075

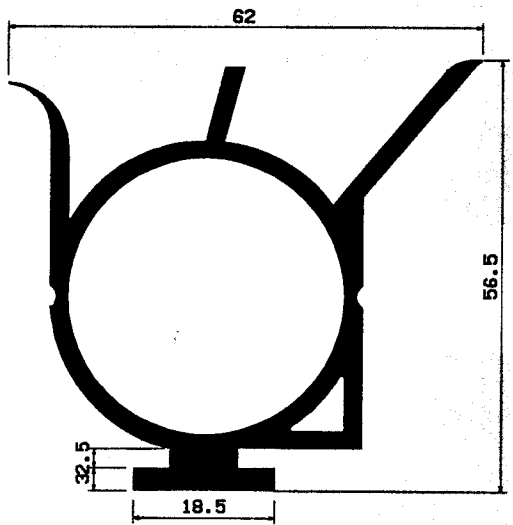





RT1077



AN1076

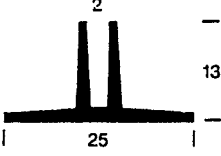
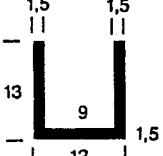
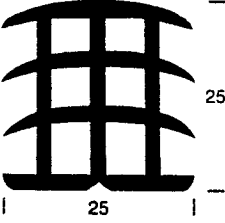
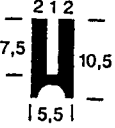
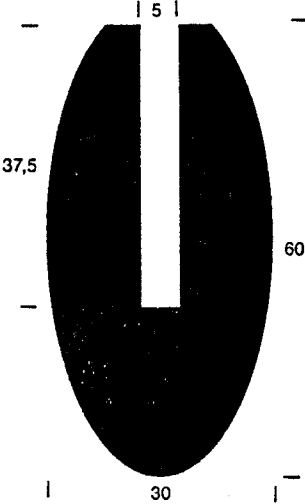
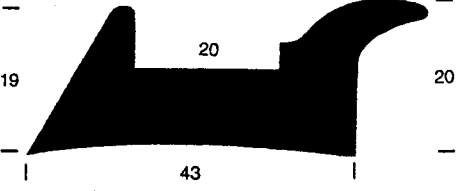
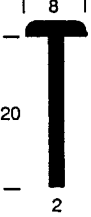
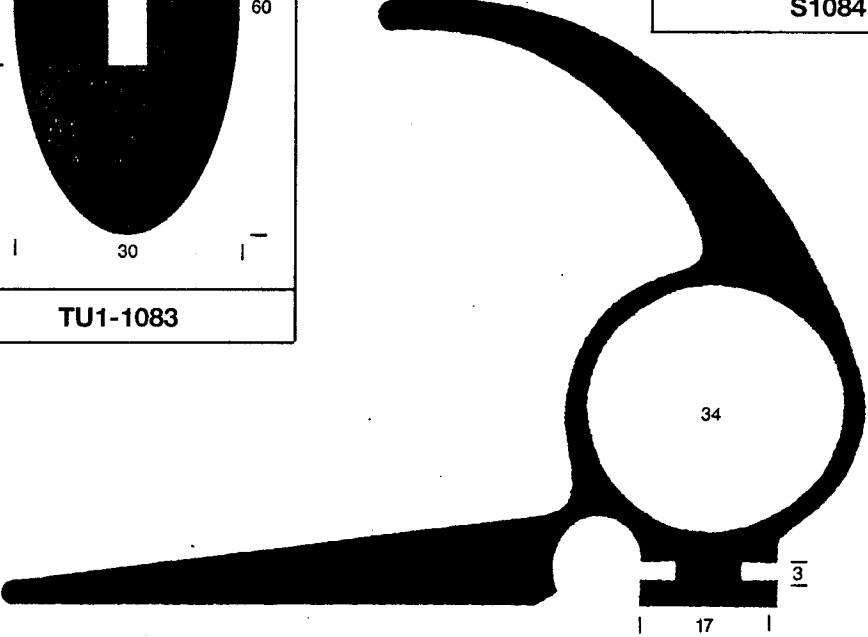
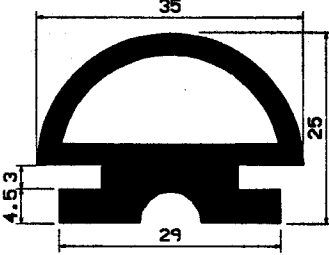
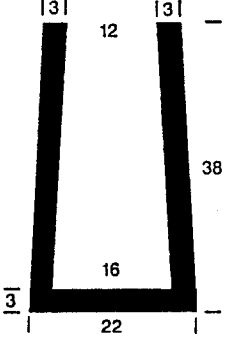

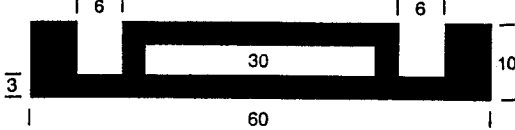
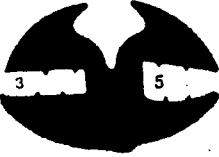
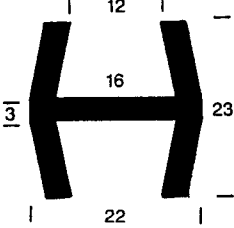
TU1-1078

 <p>S1079</p>	 <p>TU1-1080</p>	 <p>FA1081</p>	 <p>TU1-1082</p>
 <p>TU1-1083</p>	 <p>S1084</p>	 <p>T1085</p>	
 <p>RT1086</p>	 <p>RT1088</p>		
 <p>TU1-1089</p>	 <p>TU1-1090</p>	 <p>S1092</p>	 <p>KL1093</p>
 <p>H1091</p>	 <p>KL1094</p>		

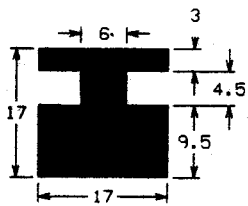

S1095

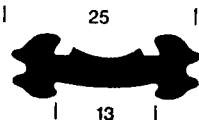

S1096

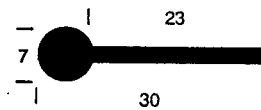

FN1097

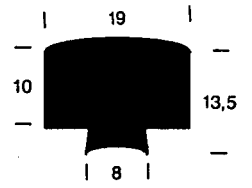

S1098

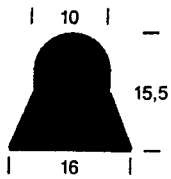

S1099

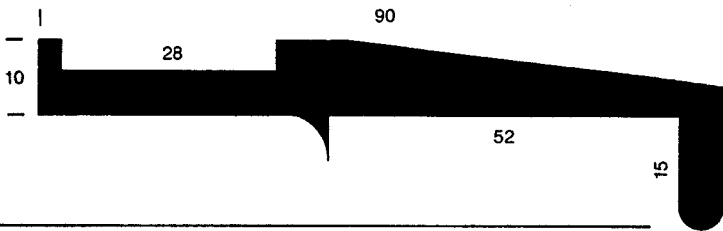

S1100

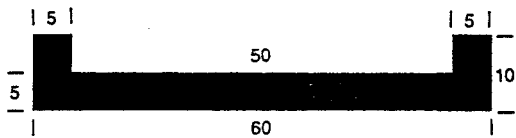

TU1-1101

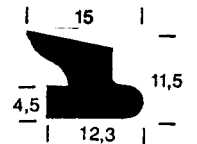

S1103

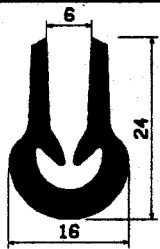

S1104



VP1105

RT1102



AN1106



AN1106/1

FT1107

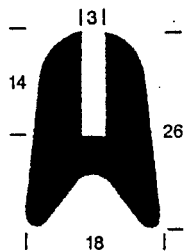

TU1-1109

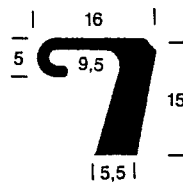



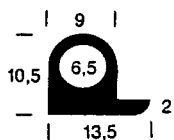



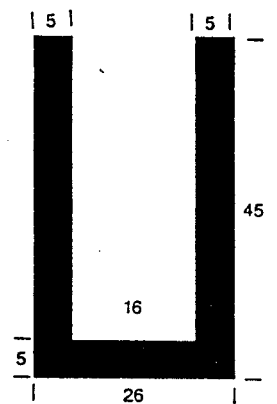

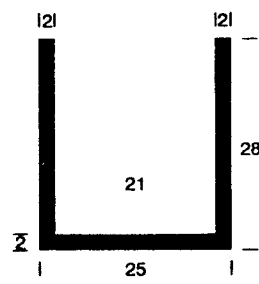

S1110



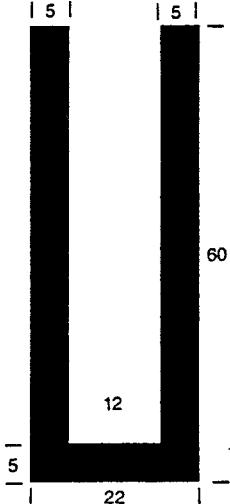
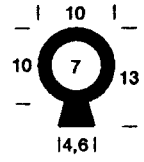

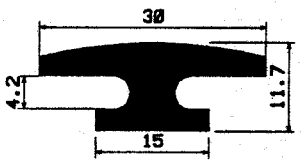
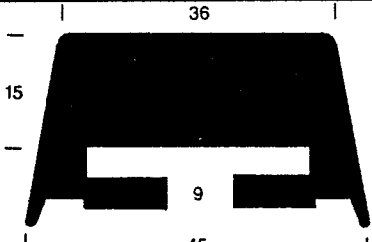

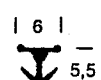
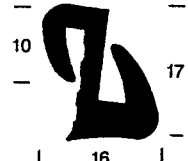
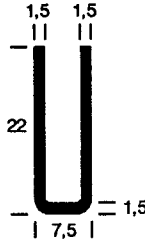

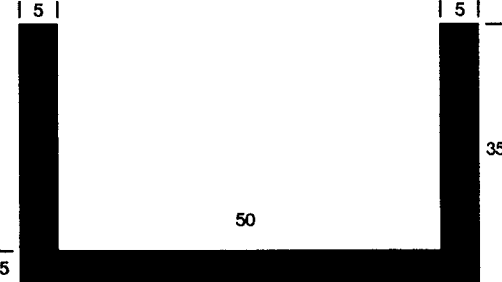
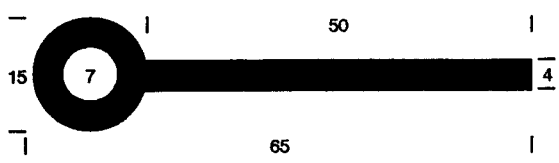
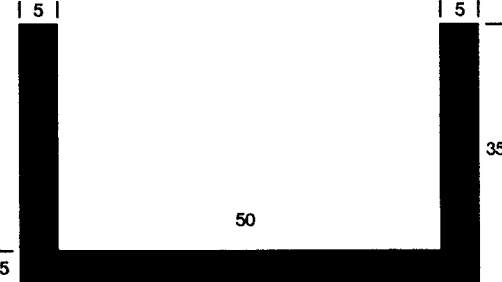

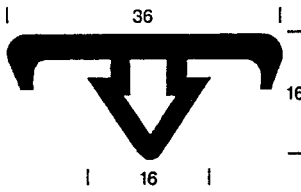
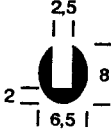
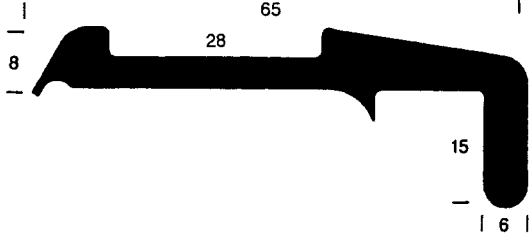
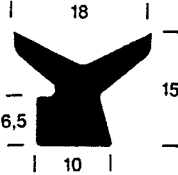

S1108

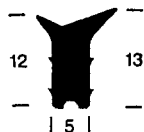
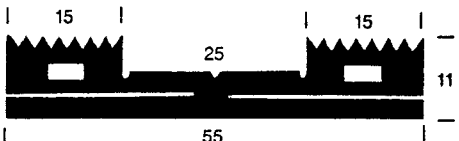
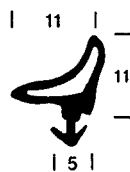
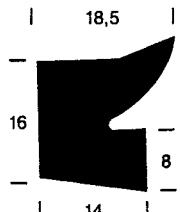
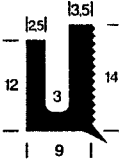
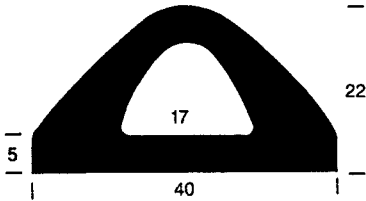

TU1-1111

			
<p>S1112</p>	<p>TU1-1113</p>	<p>S1114</p>	<p>MD1115</p>
			
<p>AN1116</p>	<p>FT1118</p>	<p>SC1119</p>	<p>MD1122</p>
			<p>H1120</p>
<p>H1120</p>	<p>TU1-1117</p>	<p>FT1121</p>	<p>MD1122</p>
			
<p>AN1123</p>	<p>S1124</p>	<p>TU1-1128</p>	<p>AN1125</p>
		<p>VP1126</p>	<p>S1127</p>
<p>VP1126</p>	<p>TU1-1130</p>	<p>FN1129</p>	<p>TU1-1130</p>
		<p>FN1129</p>	<p>TU1-1130</p>

			
<p><b>AU1131</b></p>	<p><b>TU1-1132</b></p>	<p><b>S1133</b></p>	
			
<p><b>S1134</b></p>	<p><b>VP1135</b></p>	<p><b>KS1136</b></p>	<p><b>KS1136/1</b></p>
			
<p><b>KS1136/2</b></p>	<p><b>S1137</b></p>	<p><b>S1138</b></p>	<p><b>FT1139</b></p>
			
<p><b>F1140</b></p>		<p><b>AN1141</b></p>	<p><b>S1142</b></p>
			
<p><b>TU1-1143</b></p>	<p><b>S1144</b></p>		
			
<p><b>KS1145</b></p>	<p><b>KS1146</b></p>	<p><b>KS1146/2</b></p>	<p><b>FT1147</b></p>



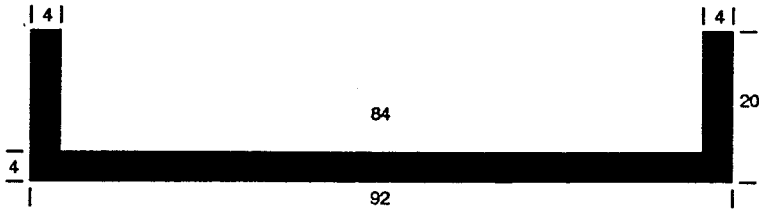

TU1-1148



FN1150

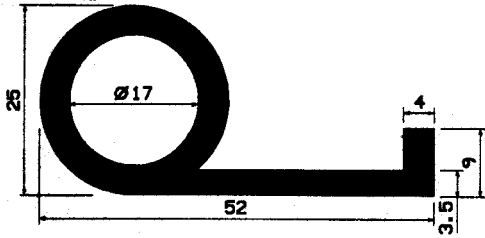

FN1149

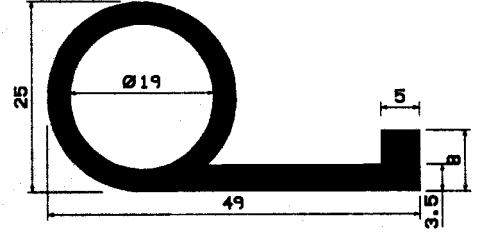

FN1151



TU1-1152

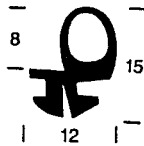

S1153

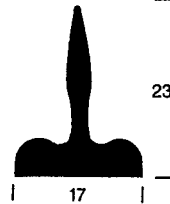

S1154



AF1155



AF1156

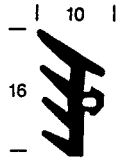

VP1157

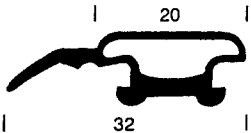

S1159

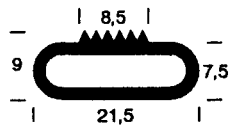

S1160

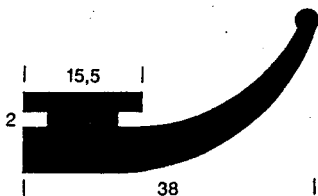

S1161

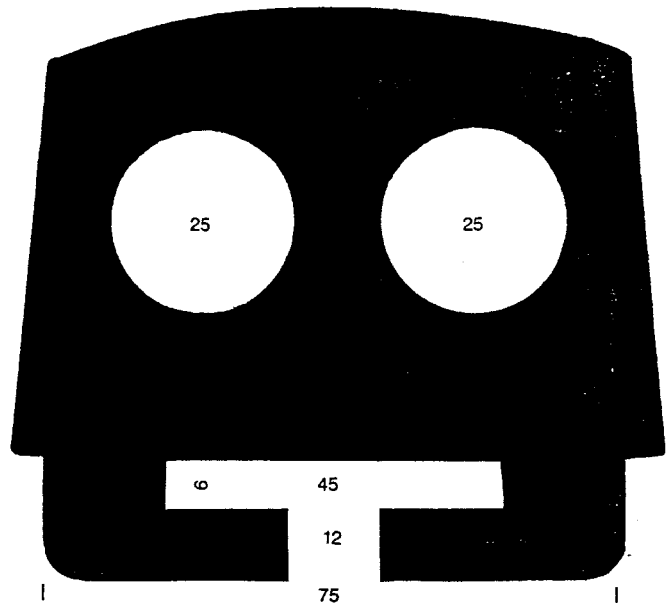

S1158

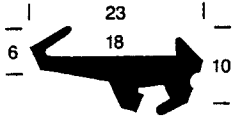

S1162

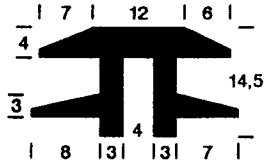

S1163



KS1165

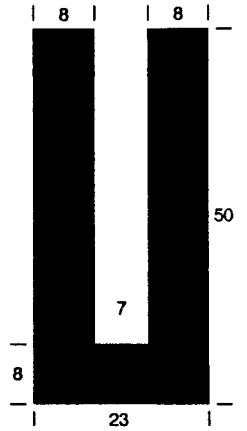

TU1-1164



AN1166

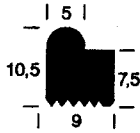

S1167



FN1168

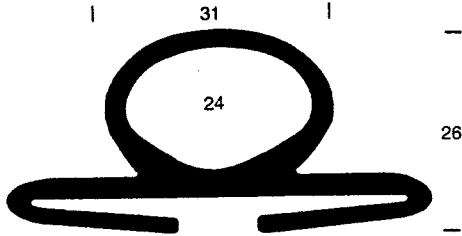

S1169



S1170

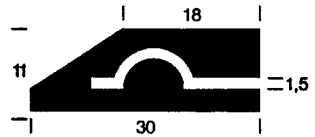

S1171

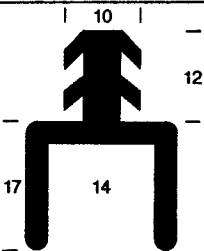

S1172



S1173

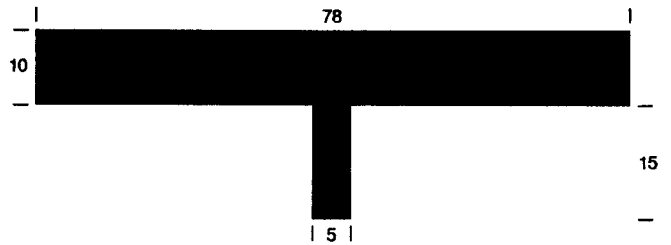

T1174



AF1175



MD1176

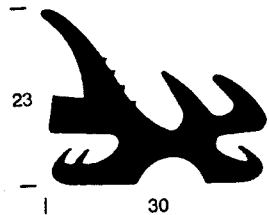

S1177

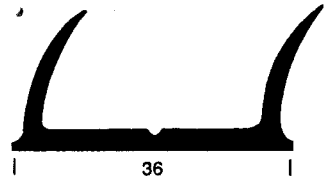

S1178

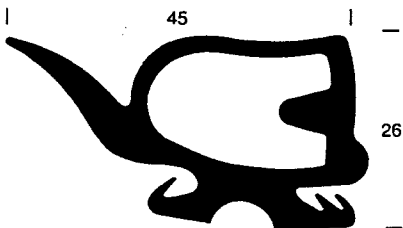

S1179

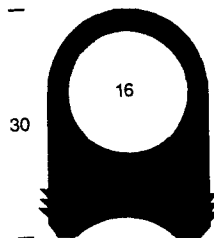

S1180



TU1-1181

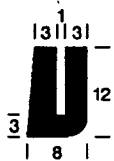

TU1-1182



FN1183

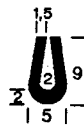

TU1-1184



AN1185



AN1185/1

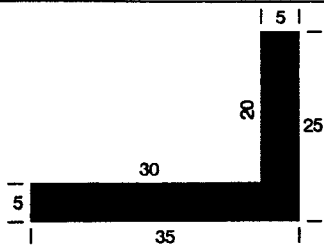

WI1186

FT1187

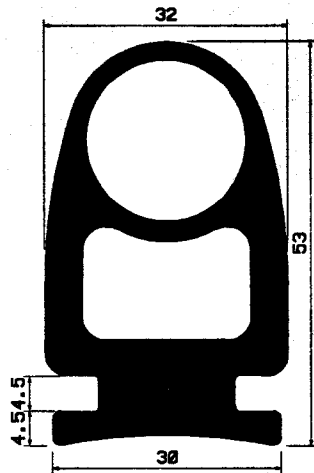

RT1188

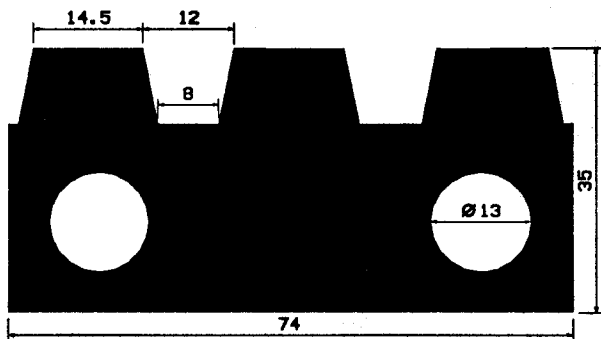

S1189

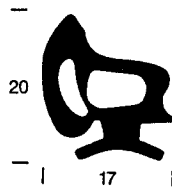

S1190

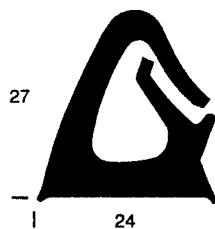

S1191

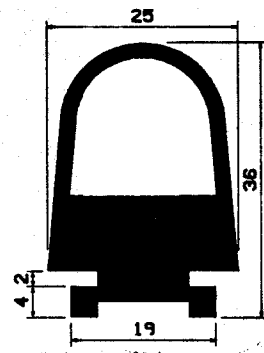

RT1192

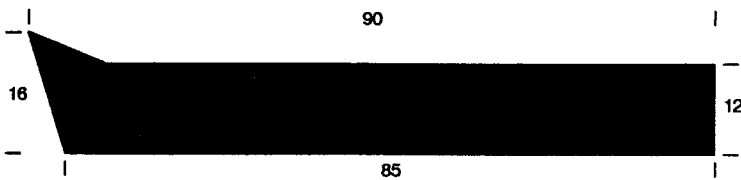

S1193

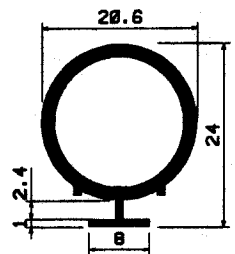

RT1194



MD1195



S1196

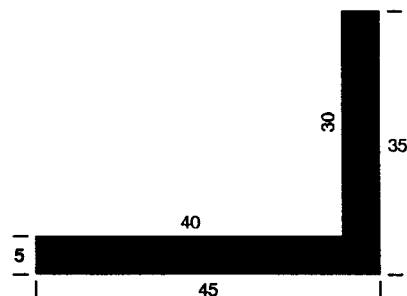

WI1197



S1198



S1199



S1200

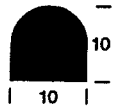

HR1201

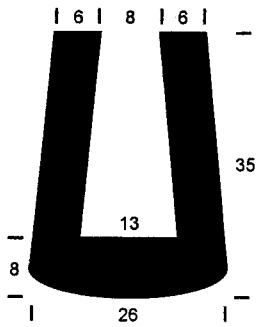

TU1-1202



S1203

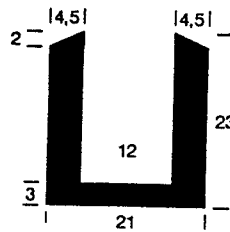

TU1-1204

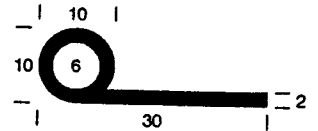

FN1205

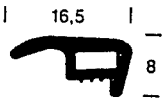

S1206



HR1208

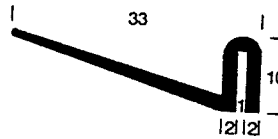

S1209

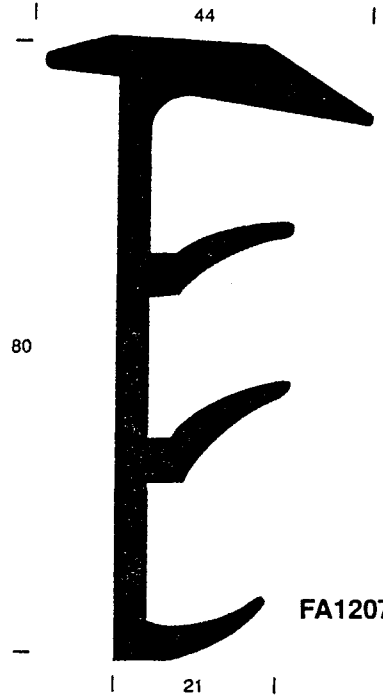

FA1207

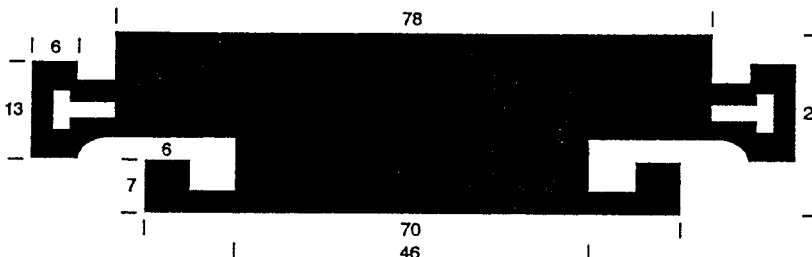

S1212



S1210



S1211



S1213

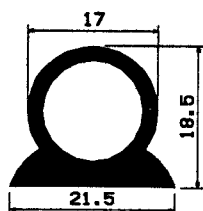

RT1214

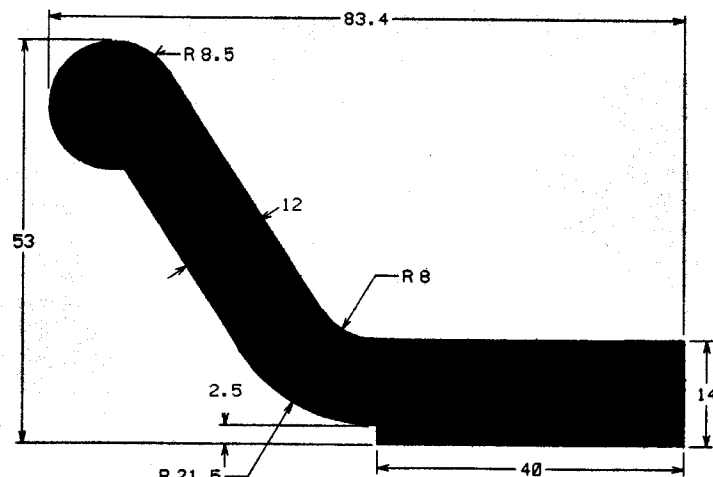

S1215

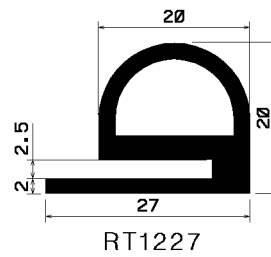
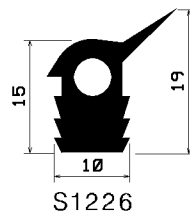
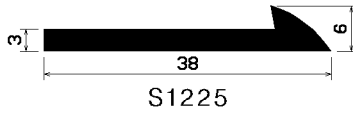
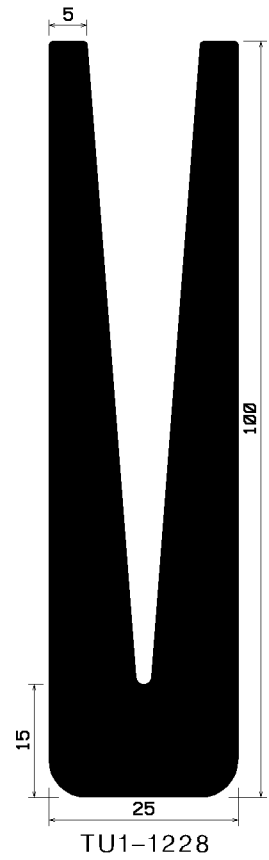
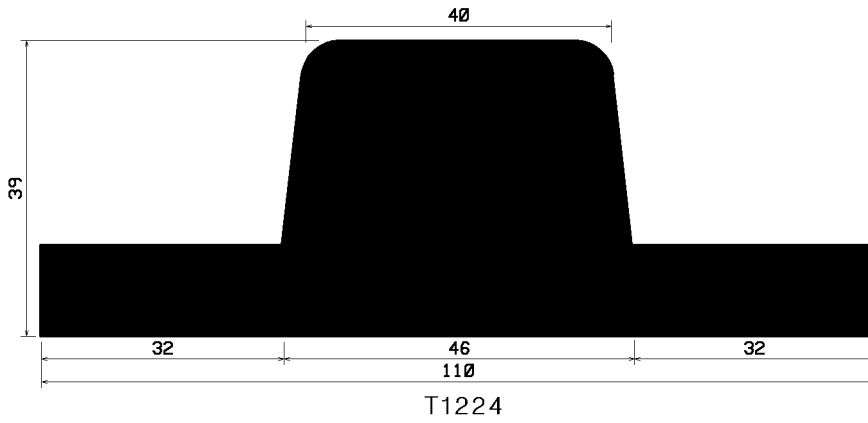
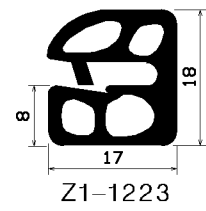
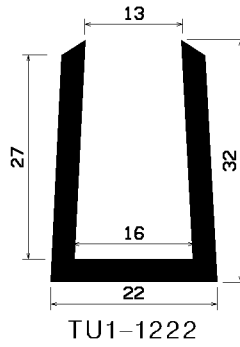
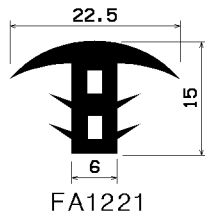
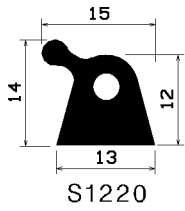
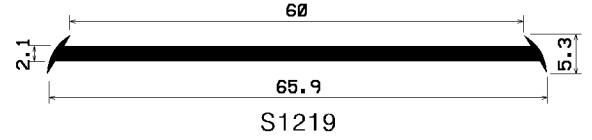
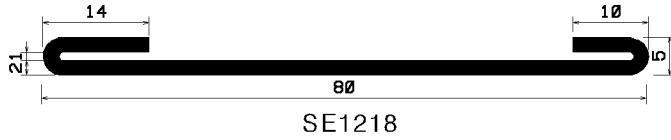
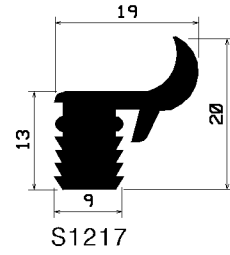
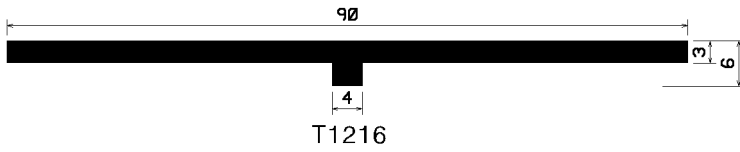

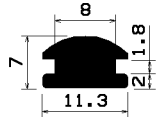

S1229

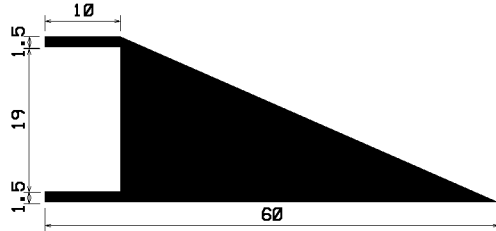

S1230

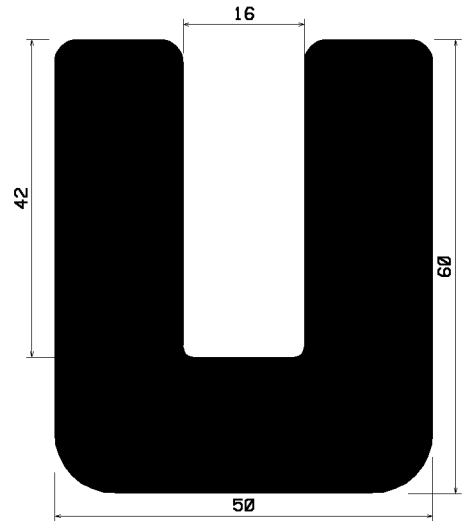

TU1-1231

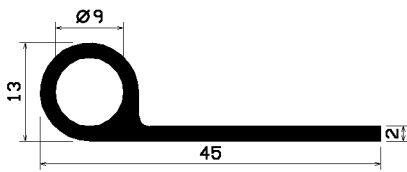

FN1232

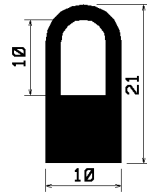

HR1233

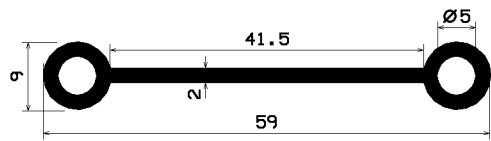

S1234

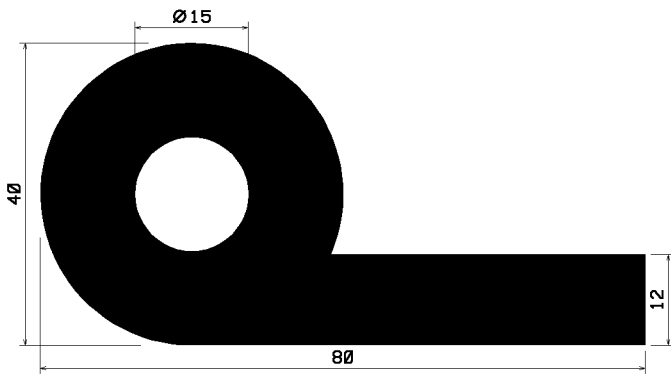

FN1235

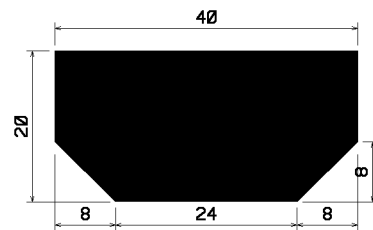

S1236

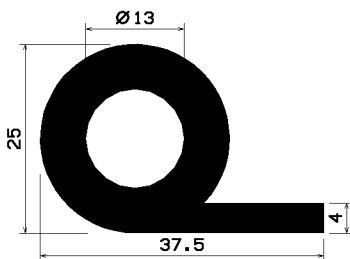

FN1237

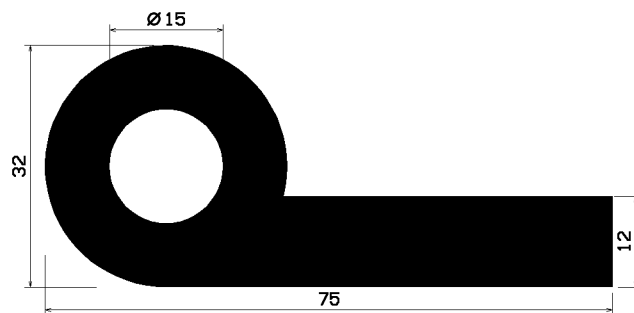

FN1238

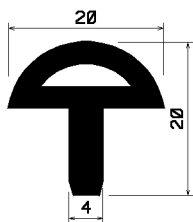

FA1239

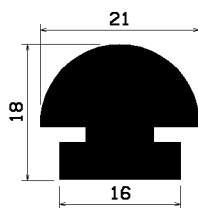

S1240

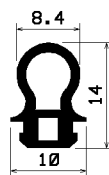

S1241

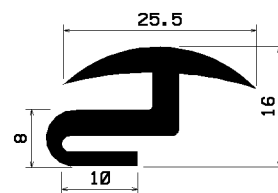

S1242

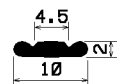

S1243

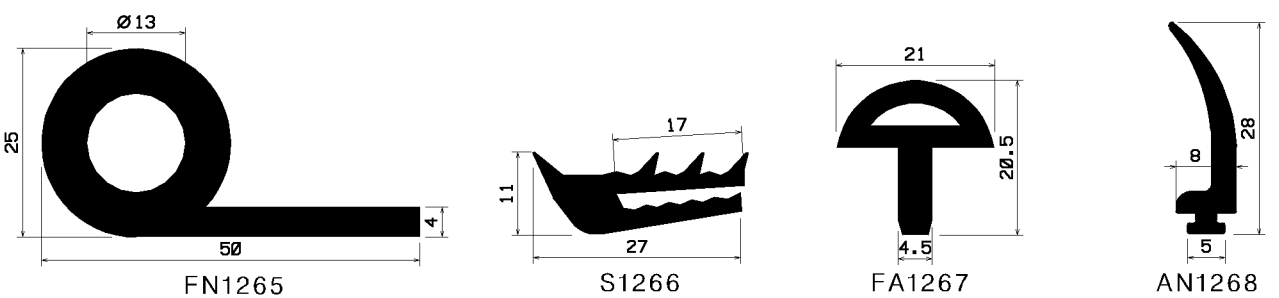
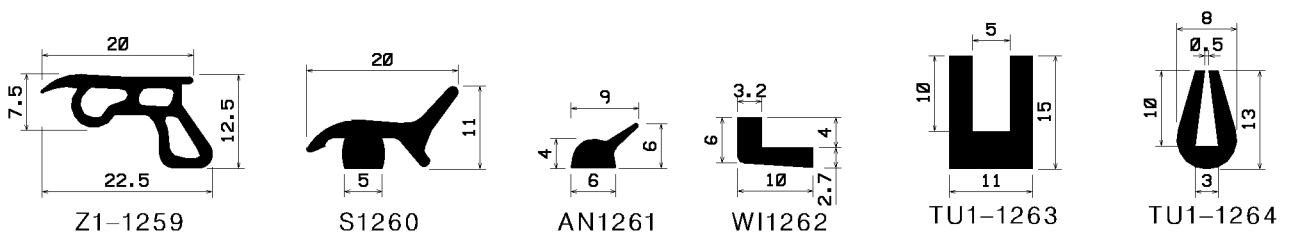
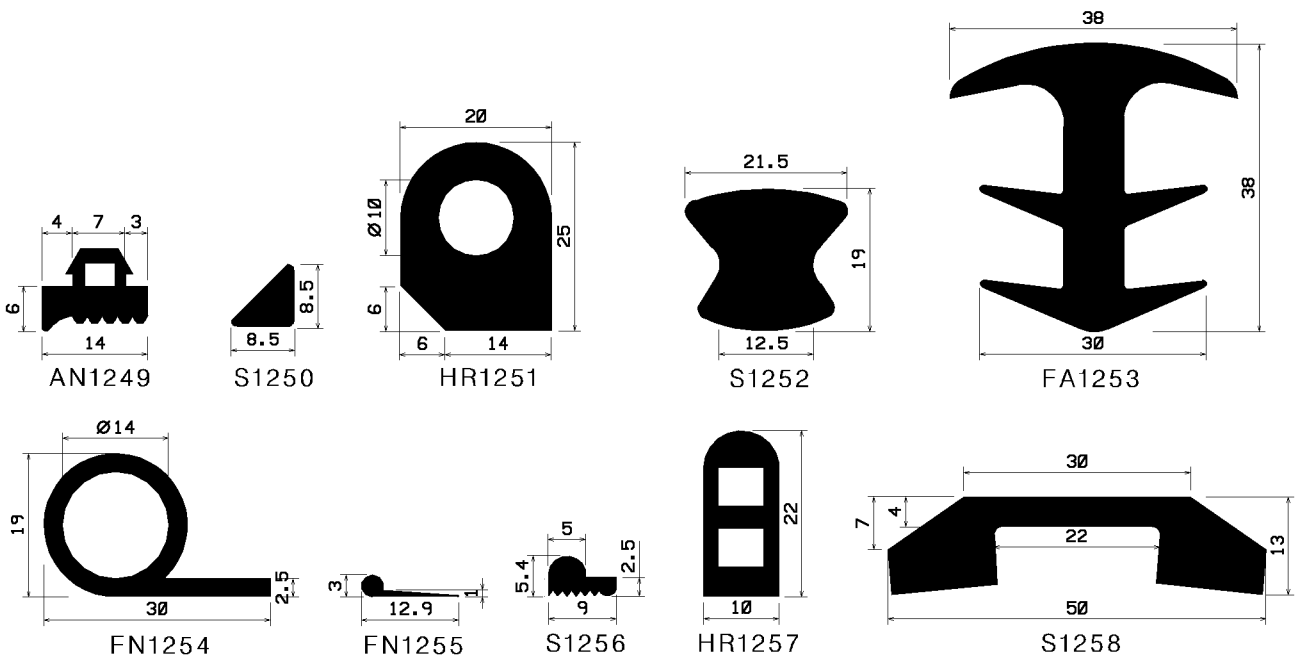
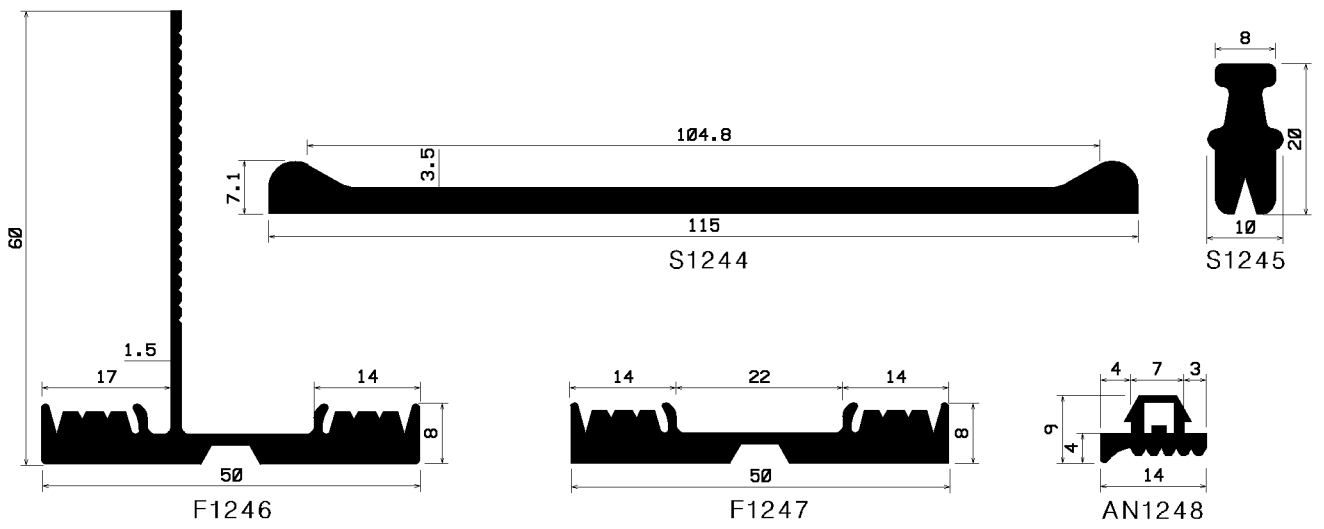

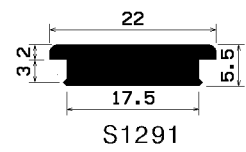
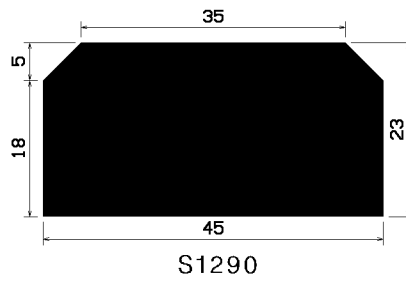
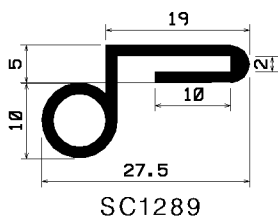
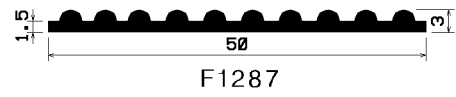
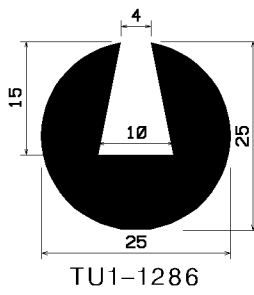
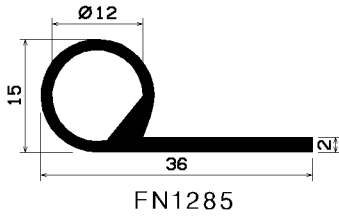
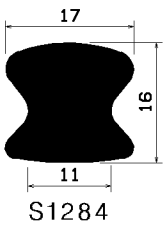
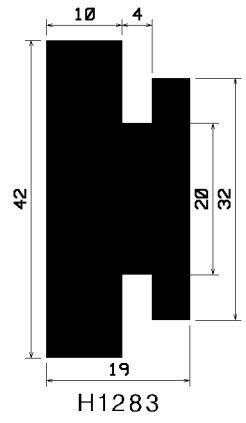
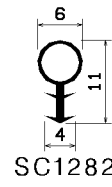
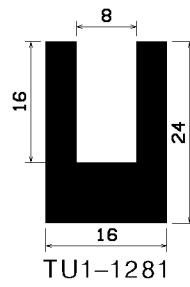
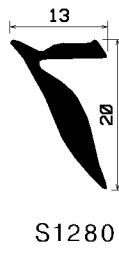
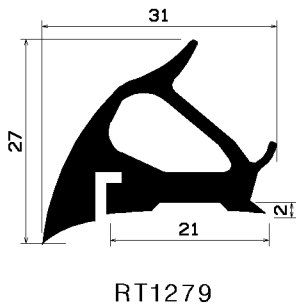
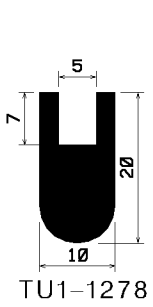
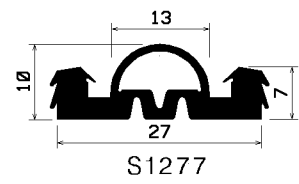
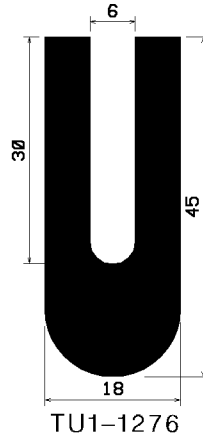
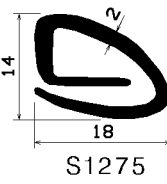
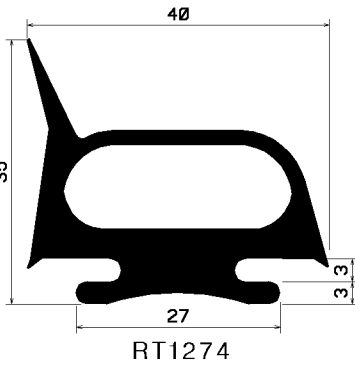
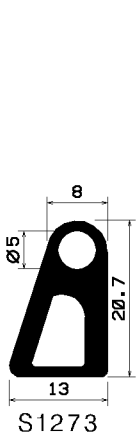
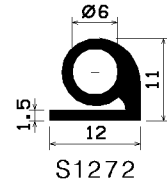
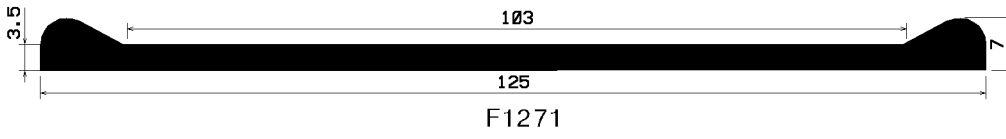
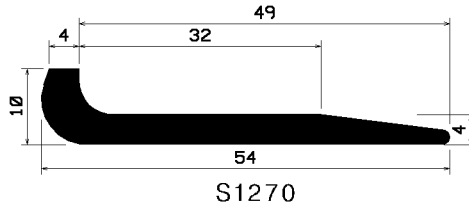
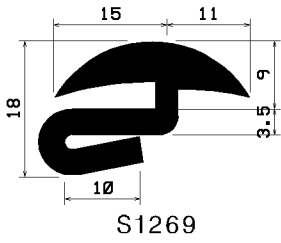



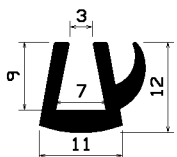

TU1-1292

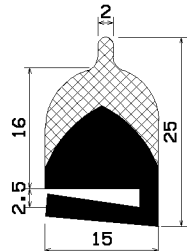

S1293

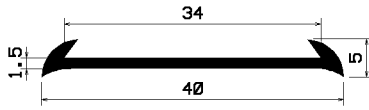

F1294

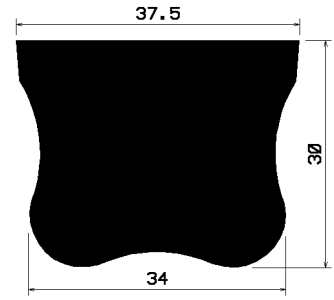

S1295

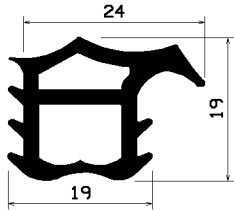

Z1-1296

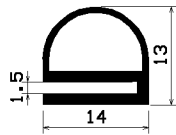

RT1297

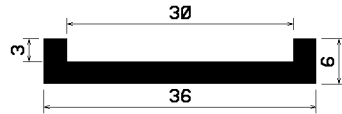

TU1-1298

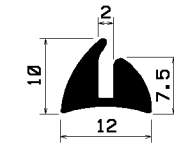

S1299

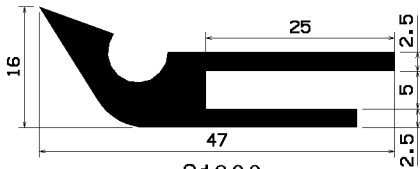

S1300

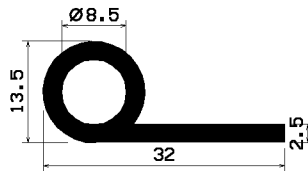

FN1301

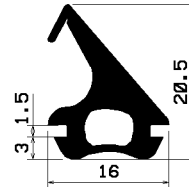

MD1302

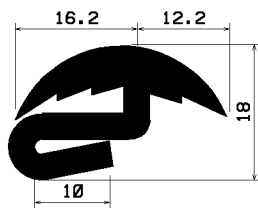

S1303

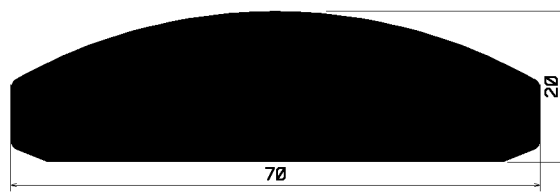

S1304

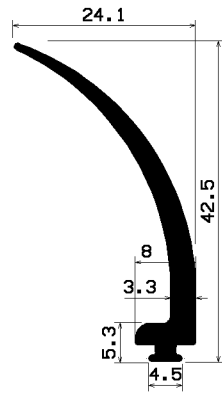

AN1305

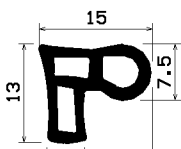

Z1-1306

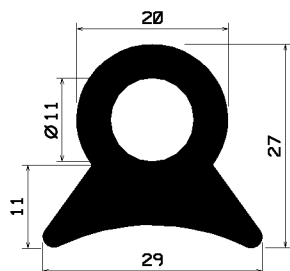

S1307

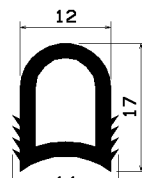

HR1308

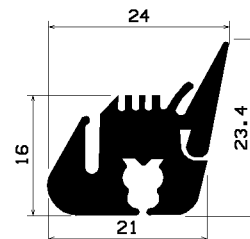

KL1309

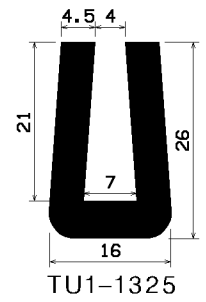
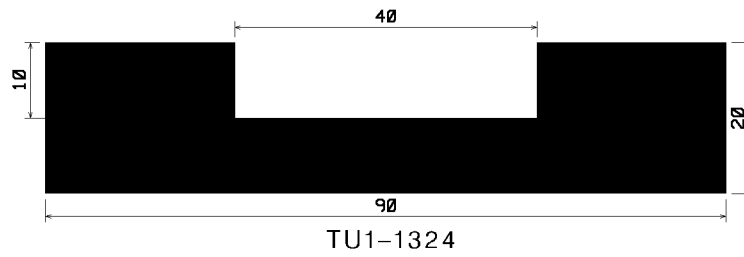
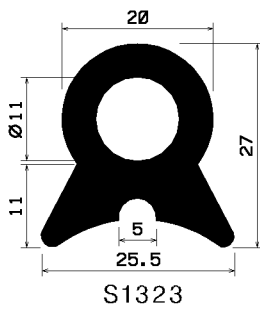
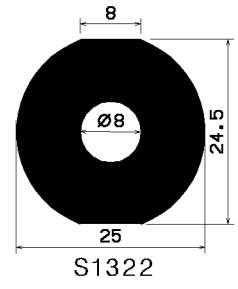
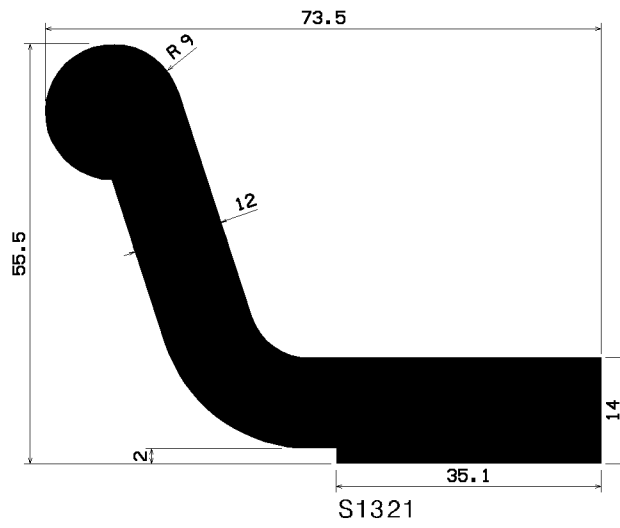
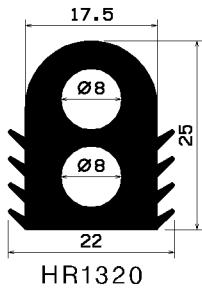
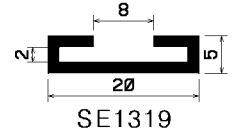
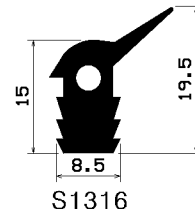
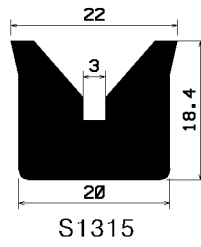
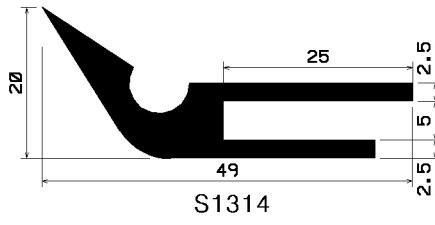
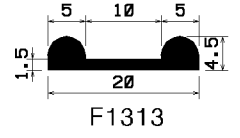
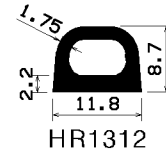
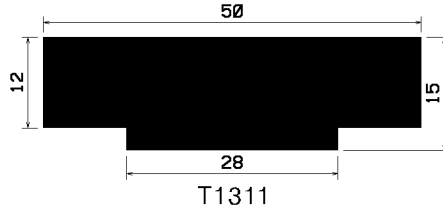
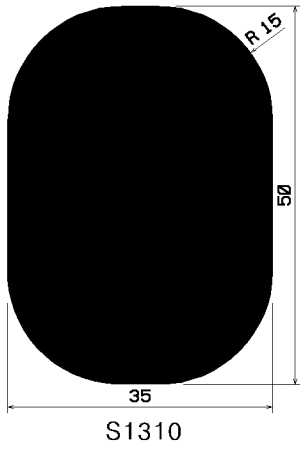

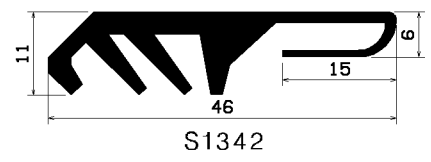
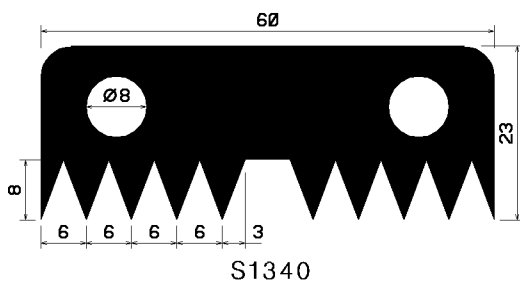
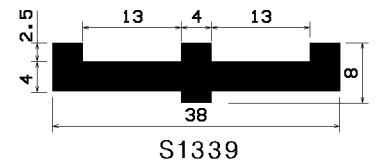
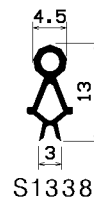
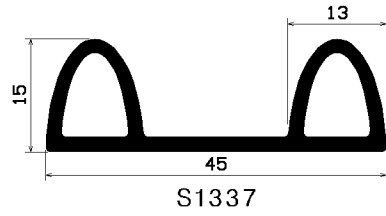
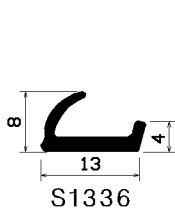
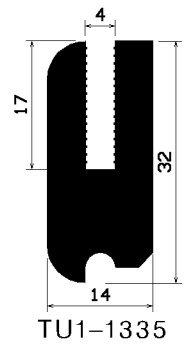
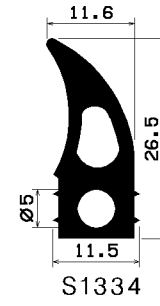
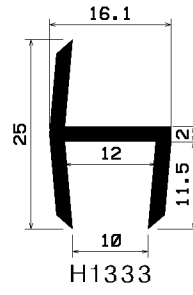
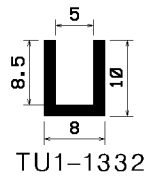
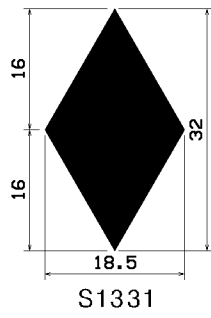
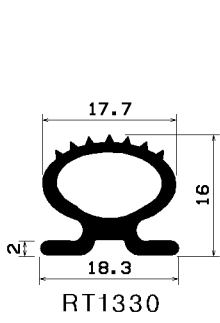
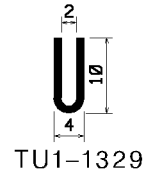
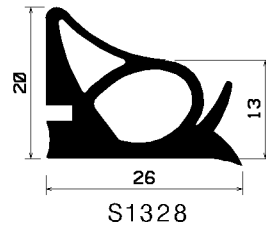
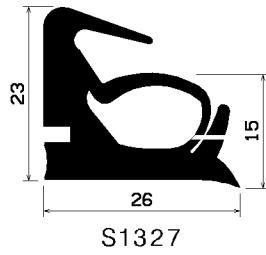
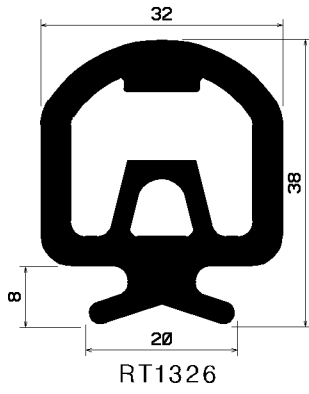

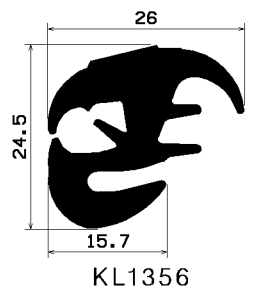
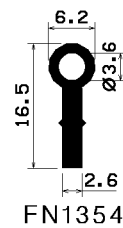
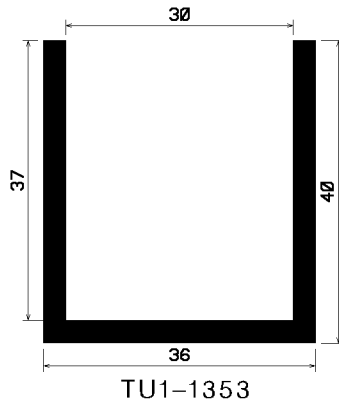
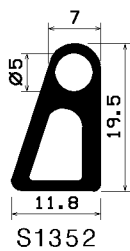
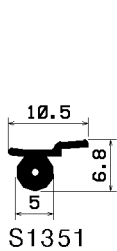
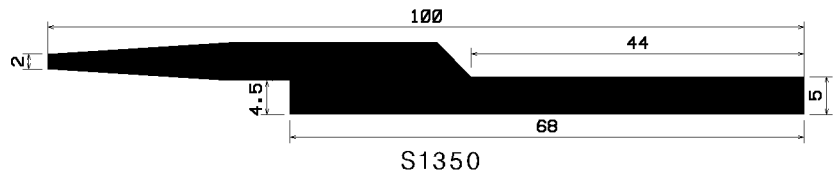
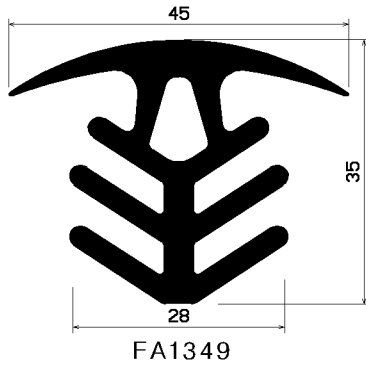
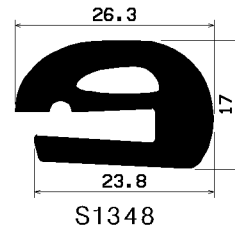
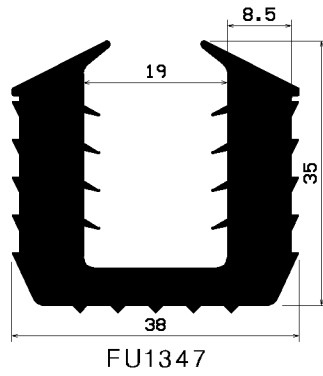
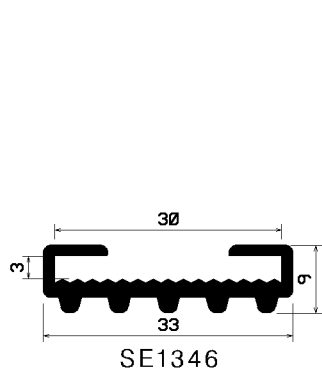
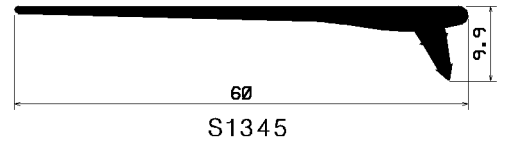
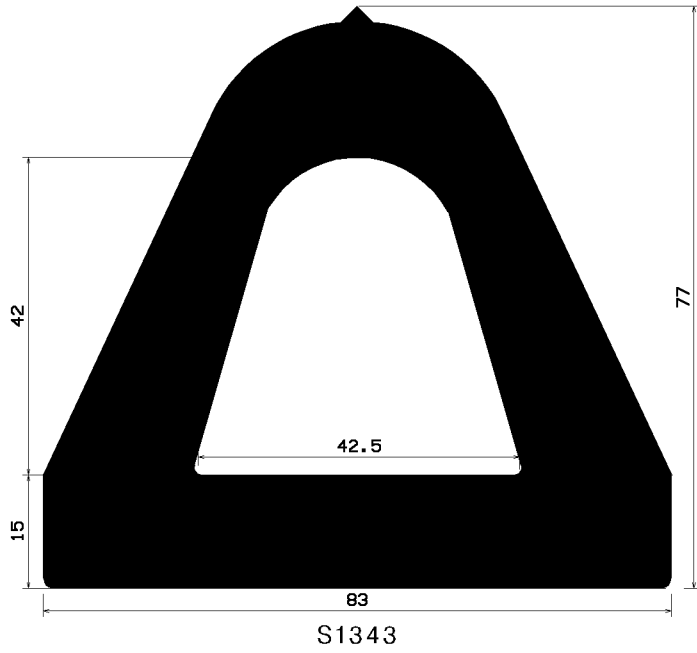

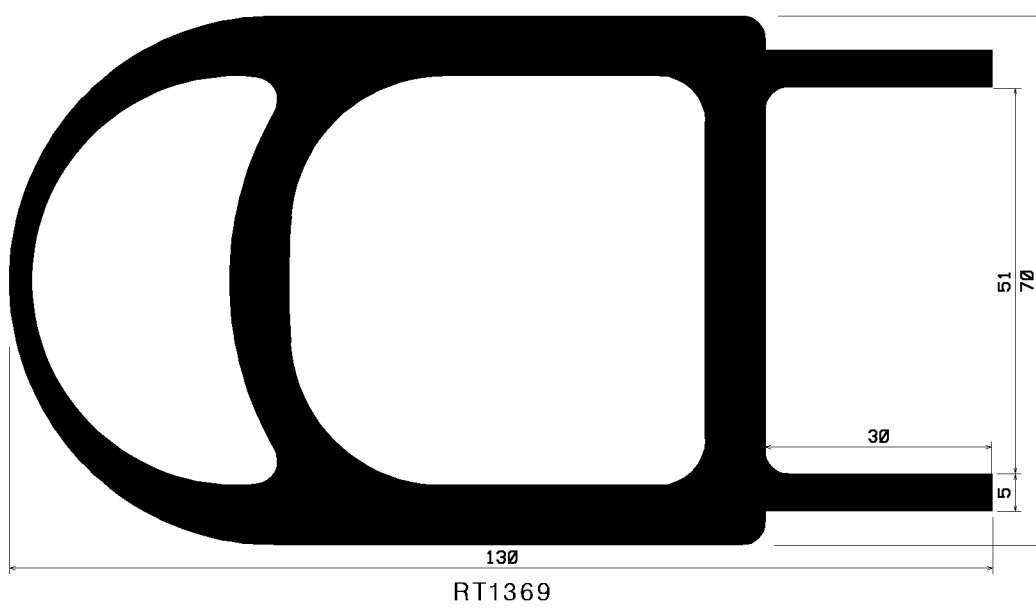
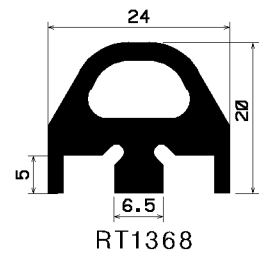
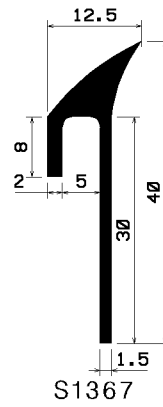
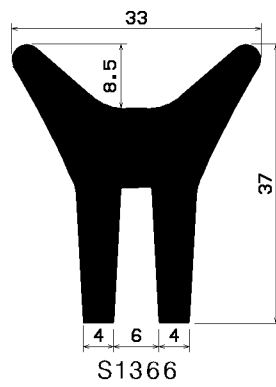
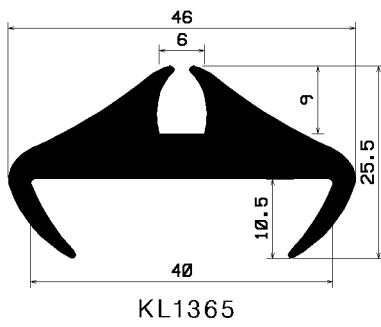
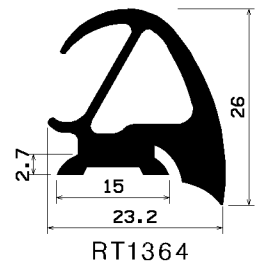
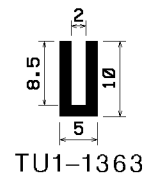
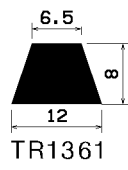
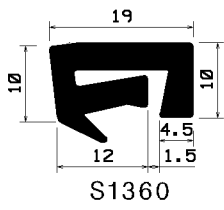
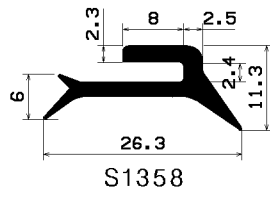
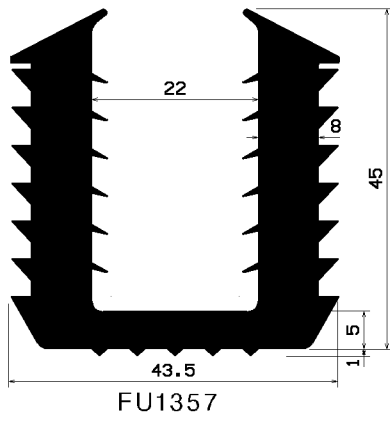

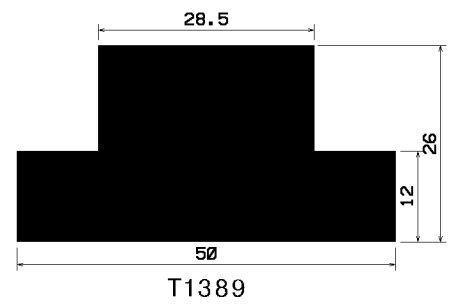
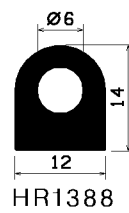
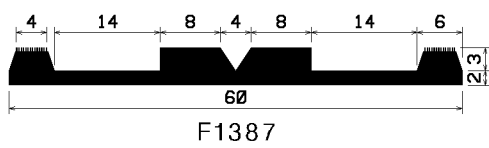
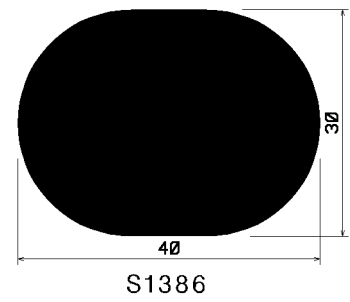
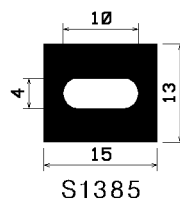
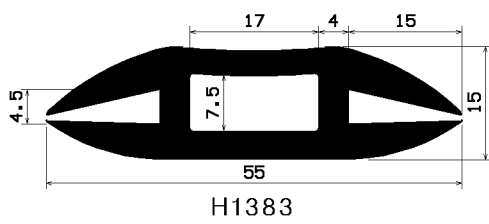
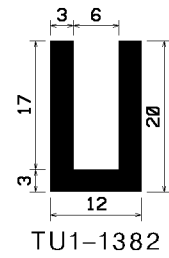
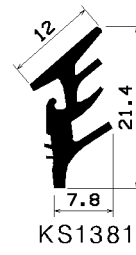
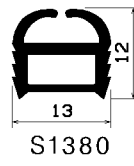
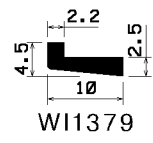
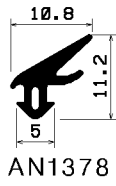
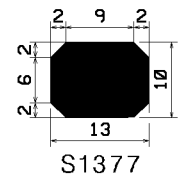
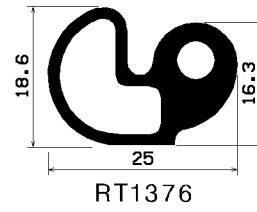
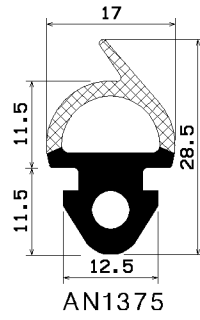
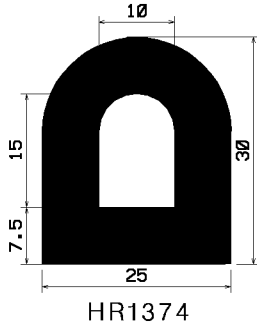
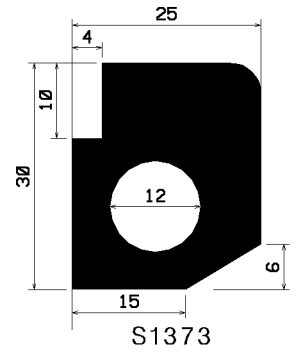
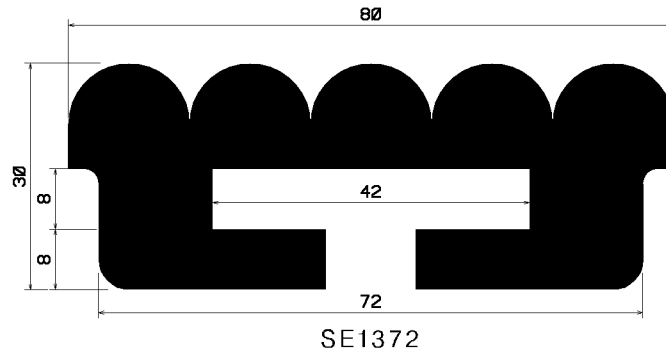
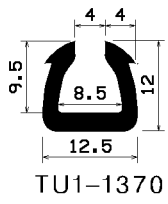

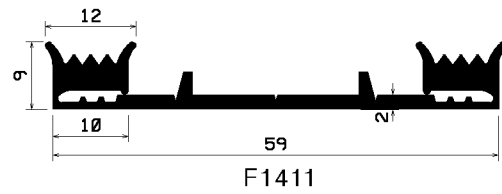
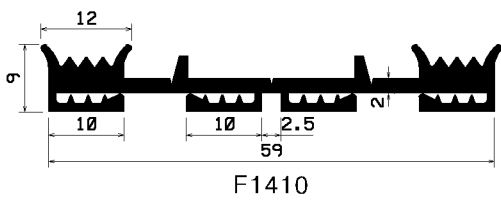
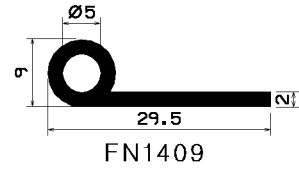
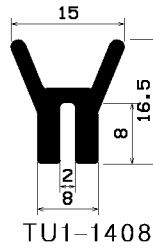
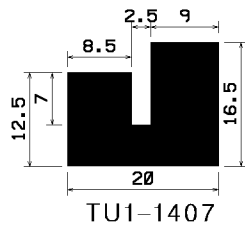
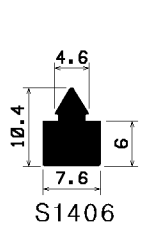
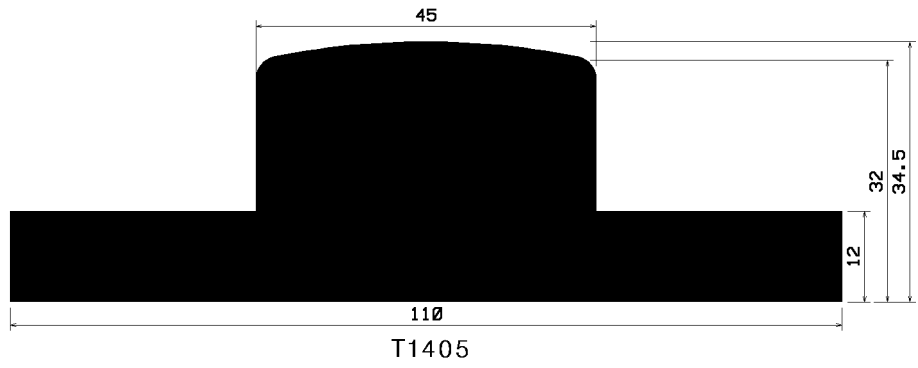
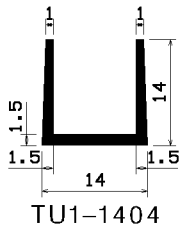
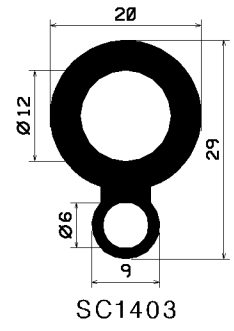
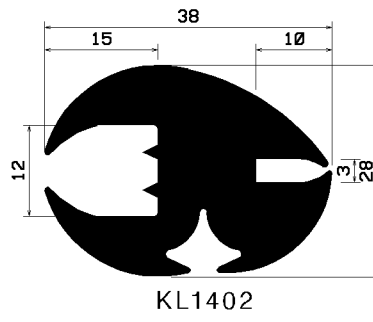
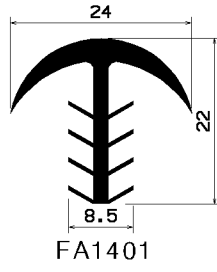
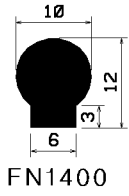
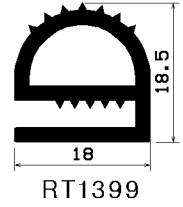
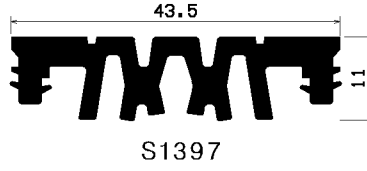
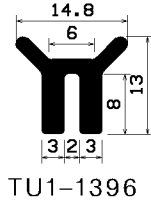
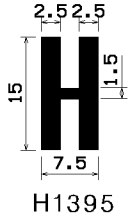
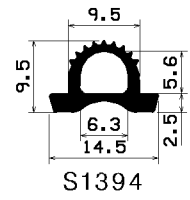
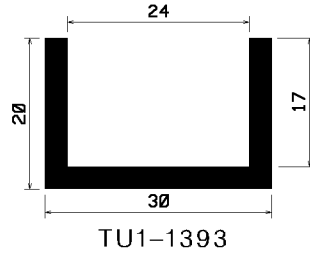
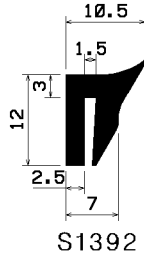
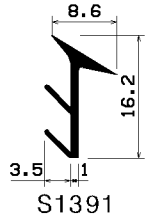
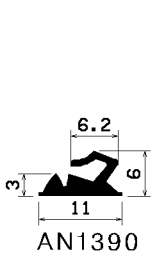

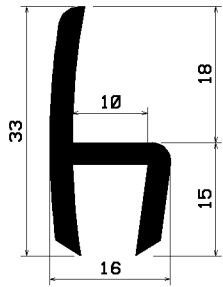

H1412

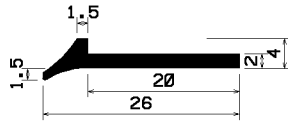

S1413

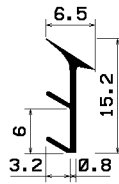

S1415

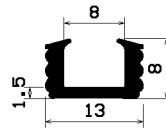

TU1-1416

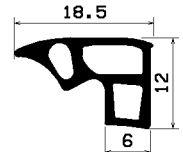

Z1-1417

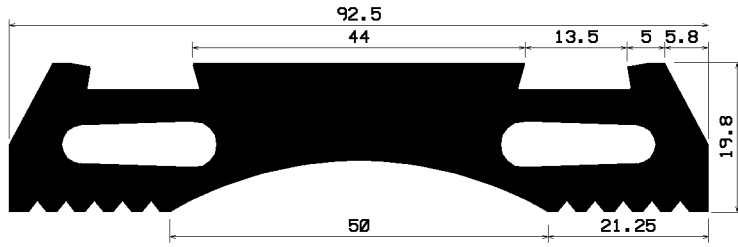

S1414

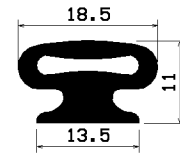

S1418

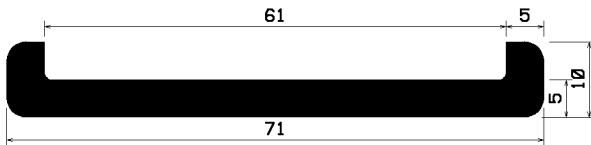

TU1-1419

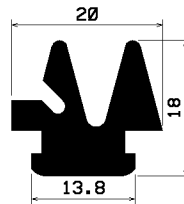

S1421

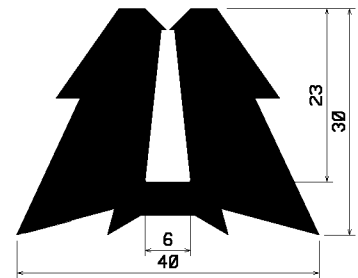

S1422



F1420

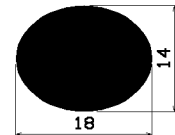

S1423

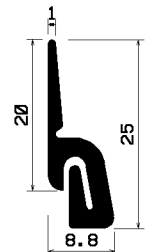

S1424

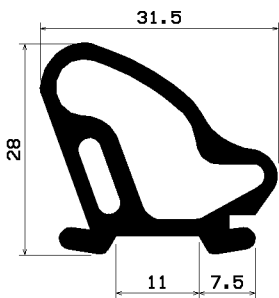

RT1425

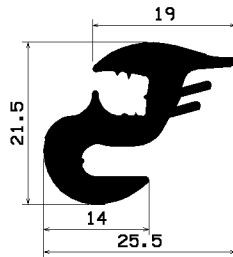

S1426

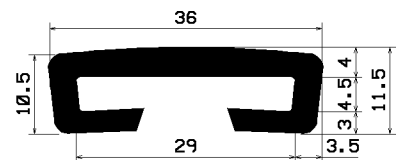

SE1427



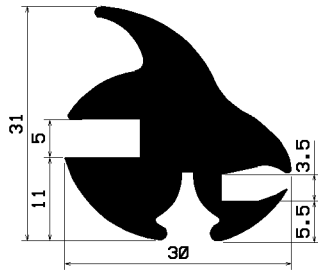

KL1428

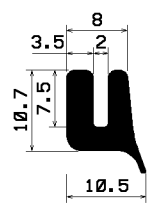

TU1-1429

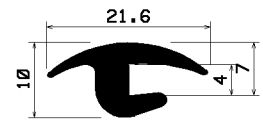

S1430

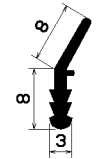

AF1431



F1432

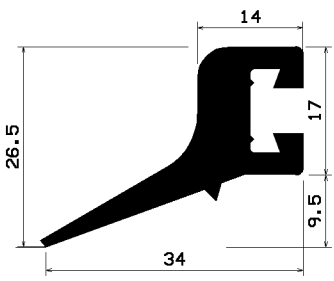

S1433

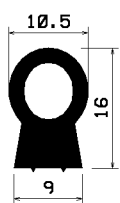

SC1435

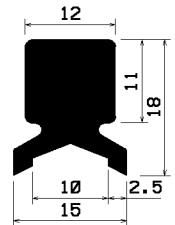

S1436

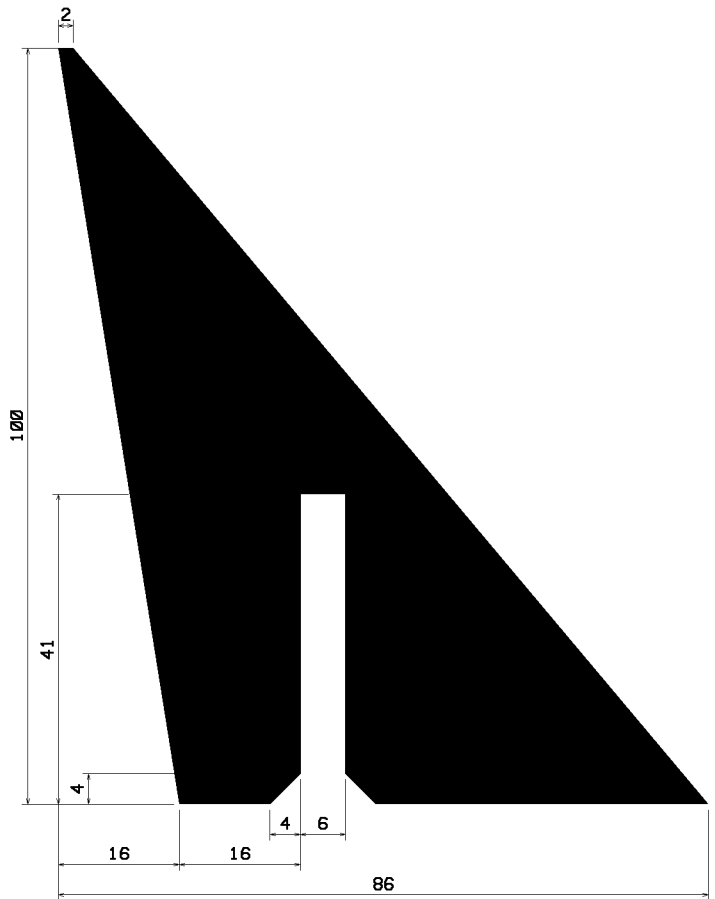

S1434

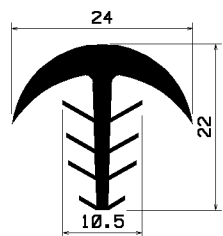

FA1437

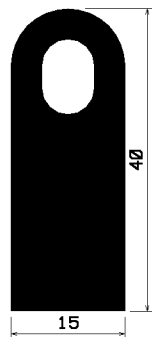

HR1438

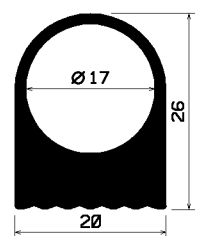

HR1439

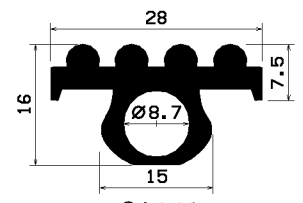

S1440

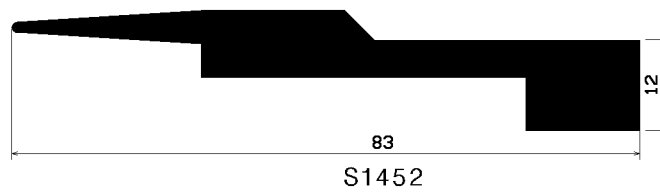
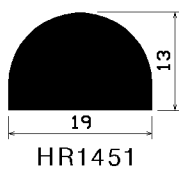
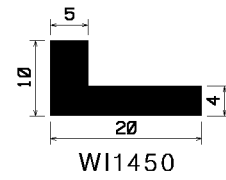
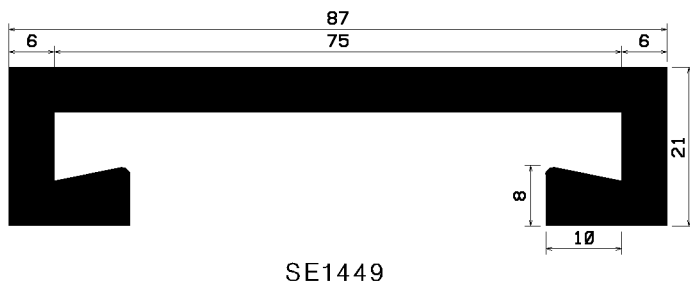
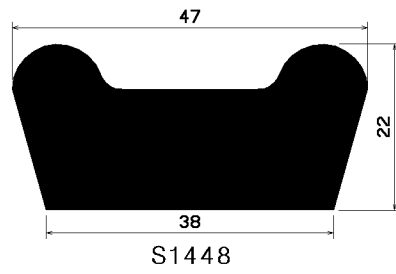
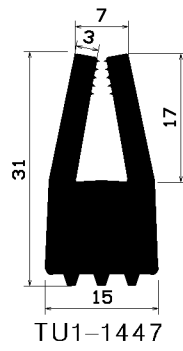
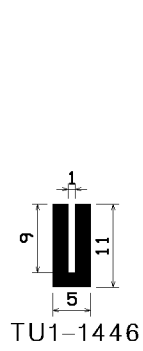
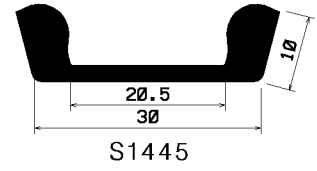
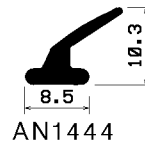
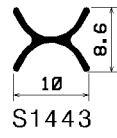
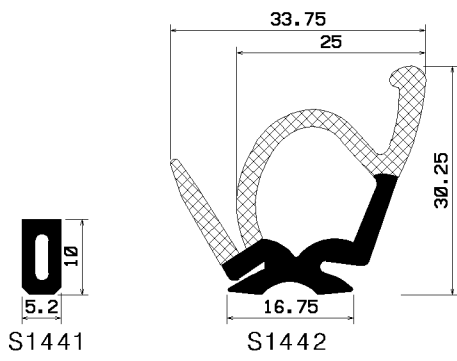

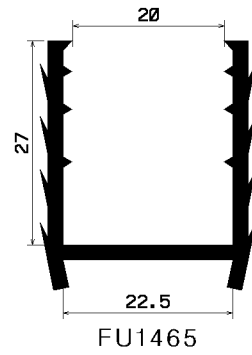
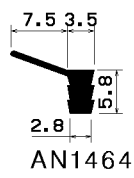
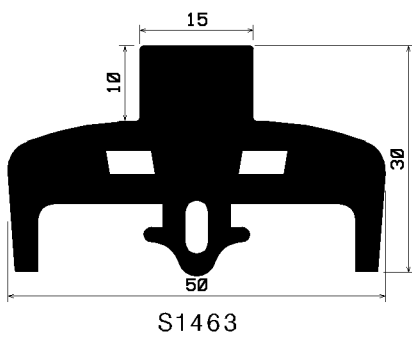
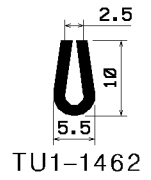
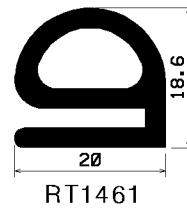
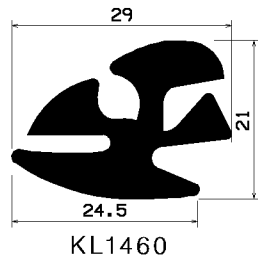
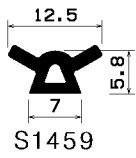
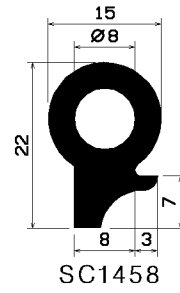
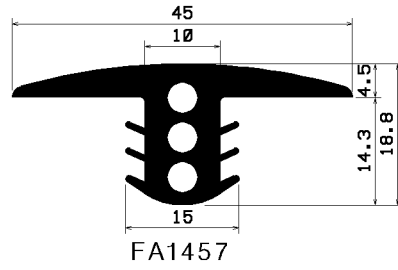
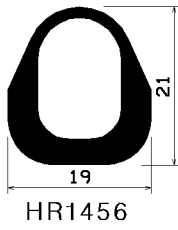
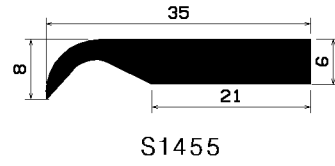
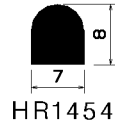
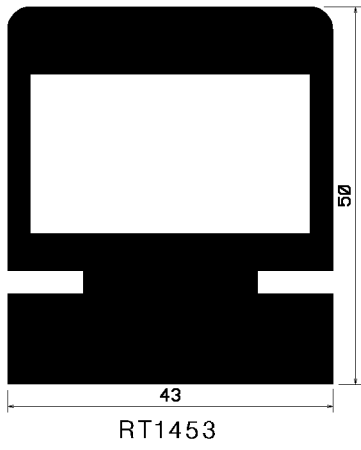

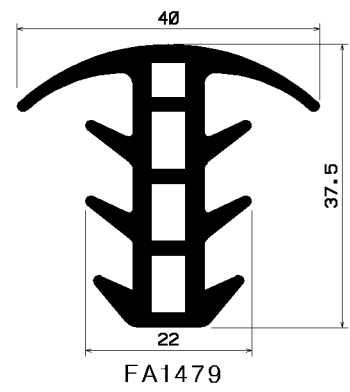
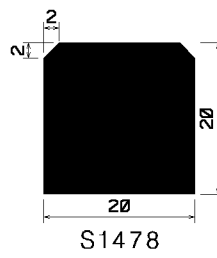
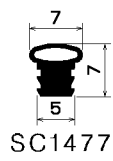
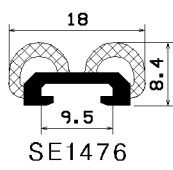
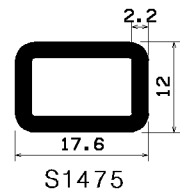
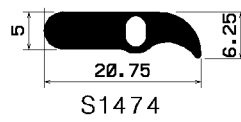
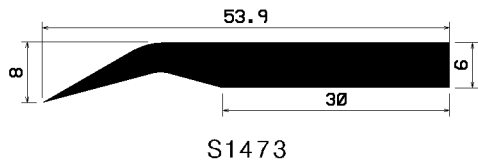
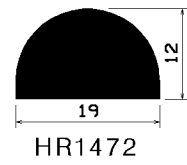
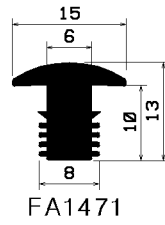
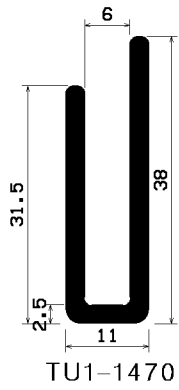
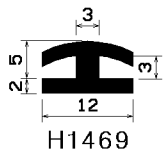
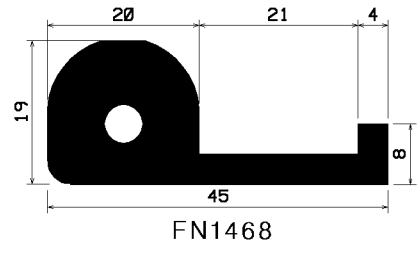
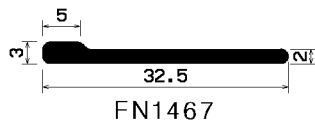
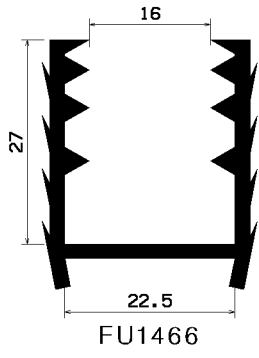

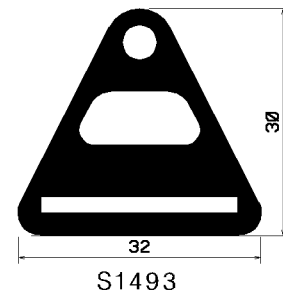
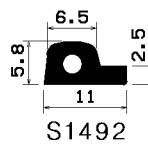
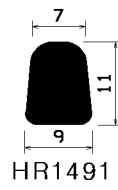
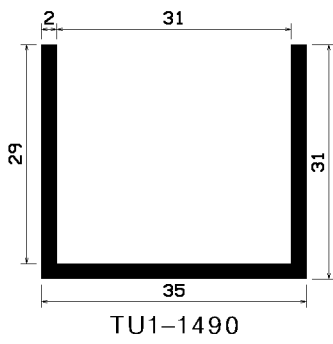
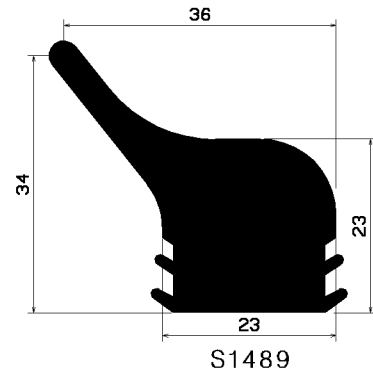
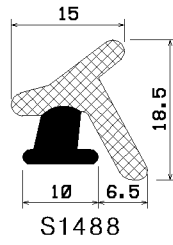
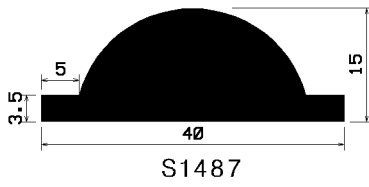
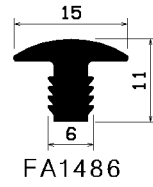
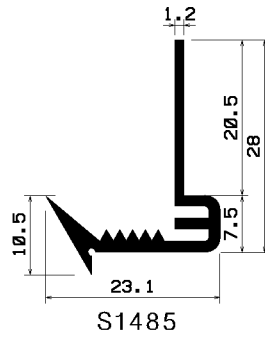
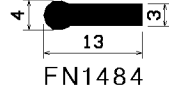
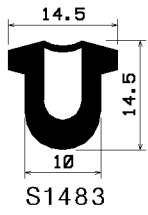
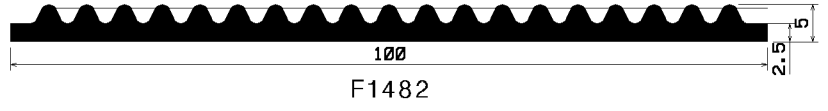
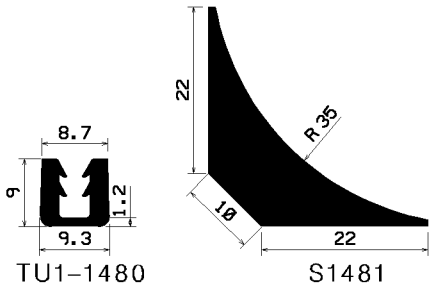

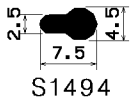

S1494

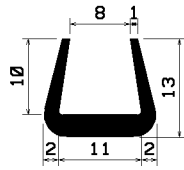

TU1-1495

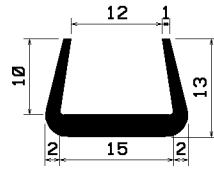

TU1-1496

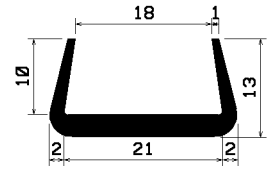

TU1-1497

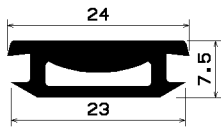

S1498



S1499

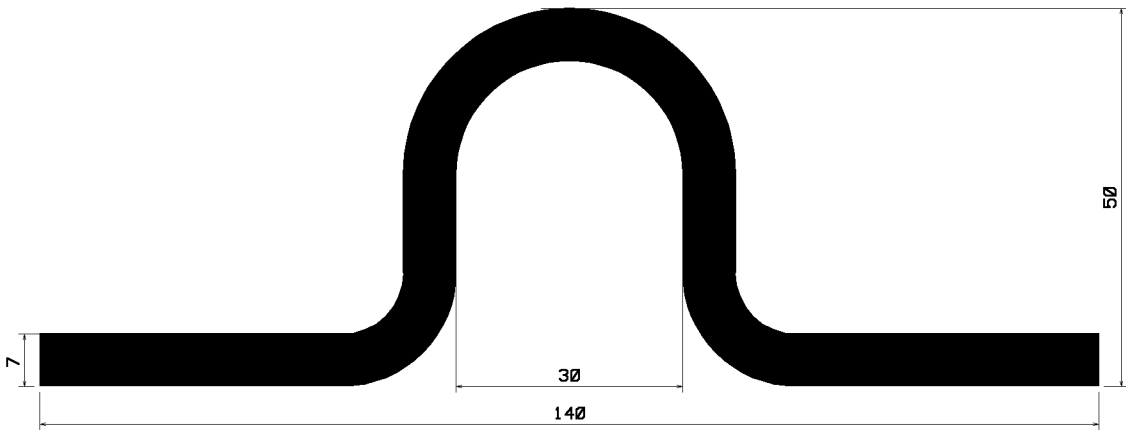

S1500

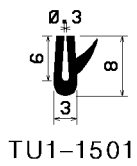

TU1-1501

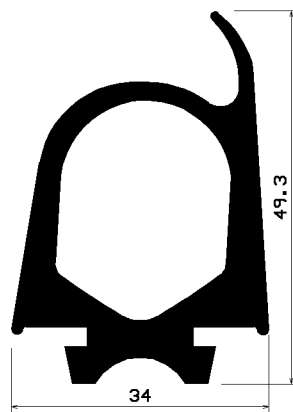

RT1502

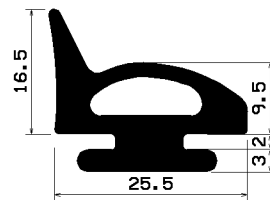

RT1503

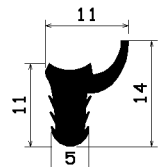

AN1504