

gummi-plast

Schild GmbH & Co.KG

Gernsheim



**Profile aus Gummi, Moosgummi,
Silikon, Schaum silikon**

D-64579 Gernsheim

Otto-Hahn-Straße 12

Telefon 0 62 58 / 932250

Telefax 0 62 58 / 4997

e-mail: schild@gummi-plast.de

internet: <http://www.gummi-plast.de>

Auflage-Profile

Liste Nr. 658

letzte Änderung: 12.08.2006

AU

Vollgummi

Zeichenerklärung

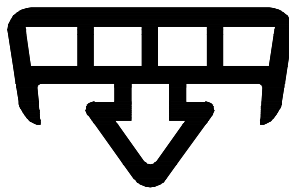

AU 9999

bedeutet

Profil-Nr.

EP / s / 9999

bedeutet

Qualität / Farbe / Artikel-Nr.

sk = selbstklebend

Qualität

CR	Neoprene
EP	EPDM
NBR	Perbunan
NK	Naturkautschuk
Si	Silikon
SPS	Silikonschaum
FPM	VITON®
PVC	Weich-PVC
SBR	Buna (Styrol-Butadien)

Farbe

s	schwarz
g	grau
w	weiß
az	anthrazit
bg	beige
br	braun
hg	hellgrau
rb	rotbraun
t	transparent
r	rot
x	Farbe wählbar

® = Eingetragenes Warenzeichen der Firma DuPont

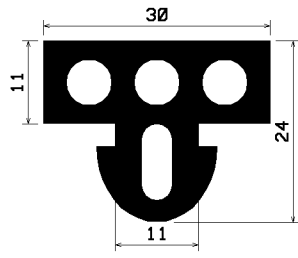

AU139
EP/s/ 1620
NK/w/1621

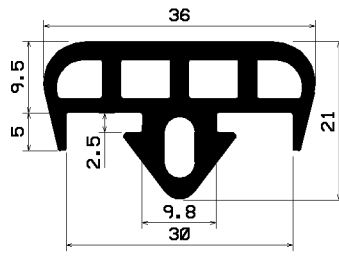

AU140
EP/s/ 1619
EP/w/ 3956

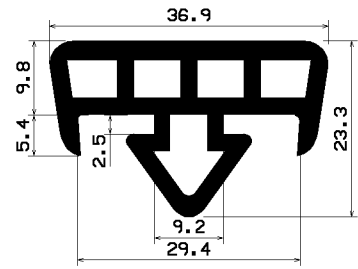

AU140/1
EP/s/ 6035

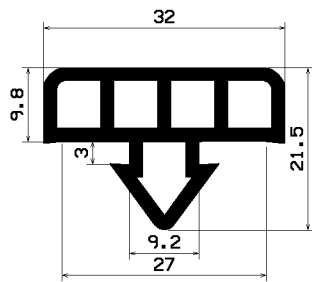

AU140/2
EP/s/ 6489

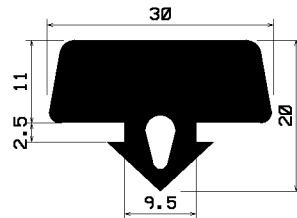

AU319
EP/s/ 3346
Si/t/ 7671

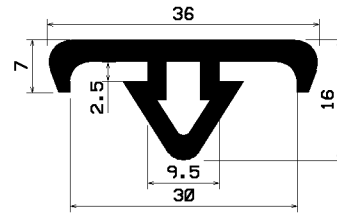

AU1131
EP/s/ 3740

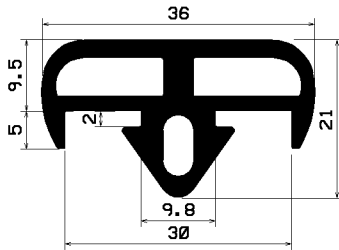

AU1528
EP/s/ 4883

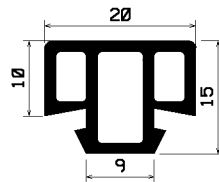

AU1531
EP/g/ 4761

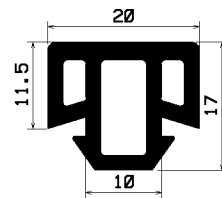

AU1549
EP/g/ 4803

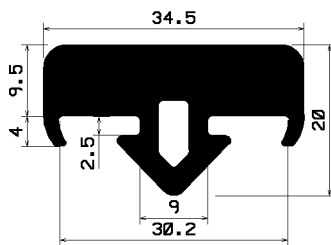

AU1583
EP/s/ 5784

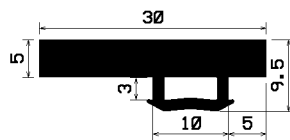

AU1690
EP/s/ 5748

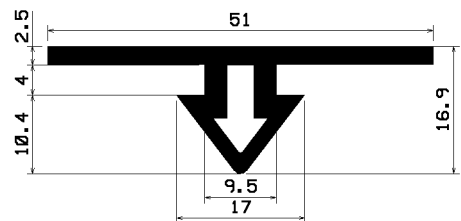

AU1938
Si/t/ 6672

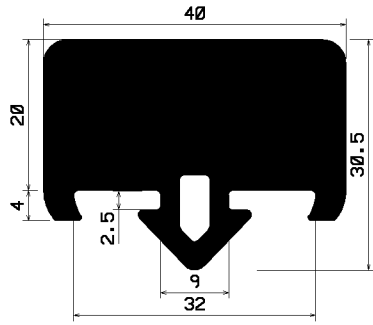

AU2103
EP/s/ 7280

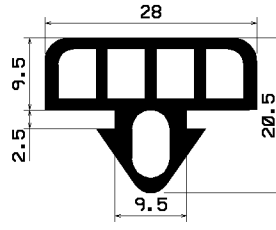

AU2324
EP/s/ 8072