



gummi-plast

Schild GmbH & Co.KG

Gernsheim



**Profile aus Gummi, Moosgummi,
Silikon, Schaum silikon**

D-64579 Gernsheim

Otto-Hahn-Straße 12

Telefon 0 62 58 / 932250

Telefax 0 62 58 / 4997

e-mail: schild@gummi-plast.de

internet: <http://www.gummi-plast.de>

Fassaden-Profile

Liste Nr. 588

Zeichenerklärung

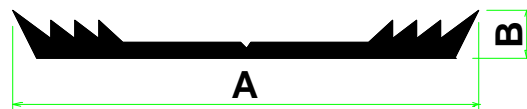

F 9999

bedeutet

Profil-Nr.

EP / s / 9999 / (9998)

bedeutet *Qualität / Farbe / Artikel-Nr. / (Artikel-Nr. mit sk)*

sk = selbstklebend

Qualität

CR	Neoprene
EP	EPDM
NBR	Perbunan
NK	Naturkautschuk
Si	Silikon
SPS	Silikonschaum
FPM	VITON®
PVC	Weich-PVC
SBR	Buna (Styrol-Butadien)

Farbe

s	schwarz
g	grau
w	weiß
az	anthrazit
bg	beige
br	braun
hg	hellgrau
rb	rotbraun
t	transparent
r	rot
x	Farbe wählbar

â = Eingetragenes Warenzeichen der Firma DuPont

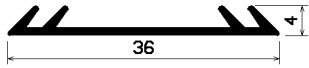

F119
EP/s/1622

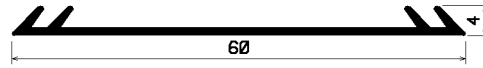

F120
EP/s/1623

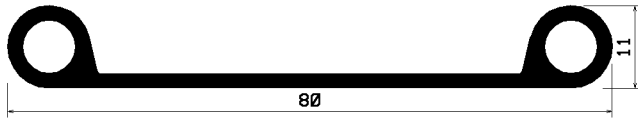

F220
EP/s/1624

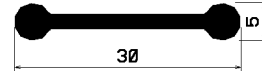

F287
EP/s/1625

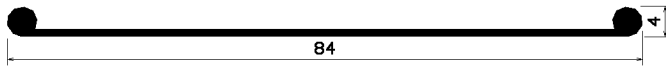

F310
PVC/bg/1041

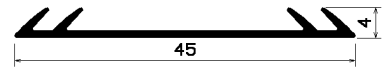

F330
EP/s/1476/(1459)

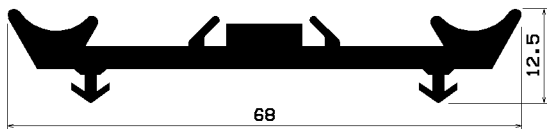

F336
EP/s/1626

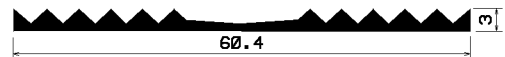

F358
EP/s/1628
EP/w/4032/(4309)



F361
EP/s/1627

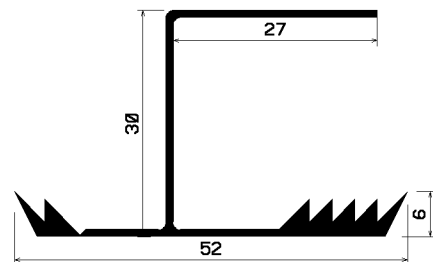

F399
EP/s/1630

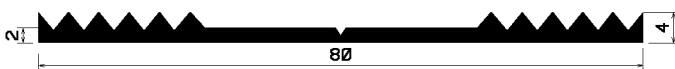

F400
EP/s/1629

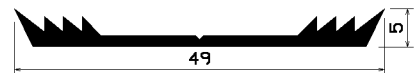

F414
EP/s/1633/(4247)

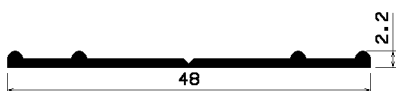

F417
EP/s/1632

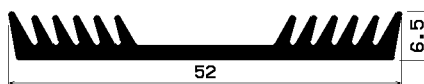

F419
EP/s/1632



F457
EP/s/1648/(1159)

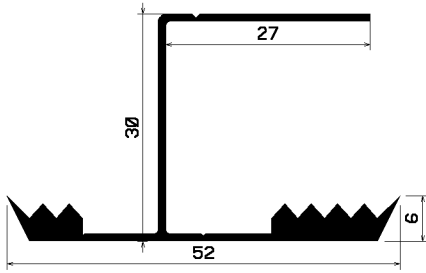

F459
EP/s/1635

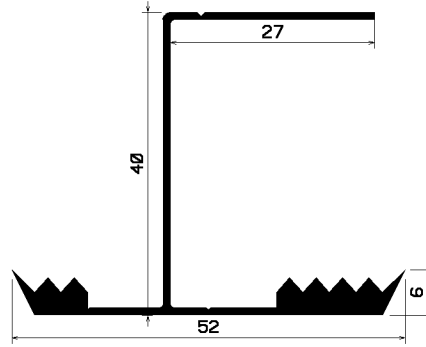

F460
EP/s/1636

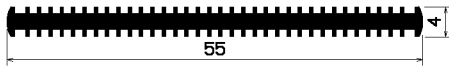

F475
EP/s/1637

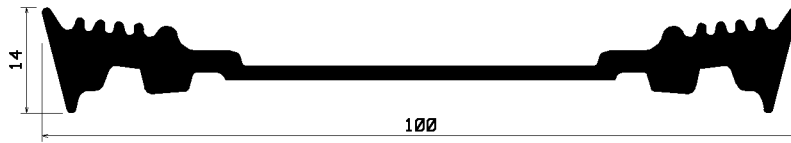

F482
EP/s/1638

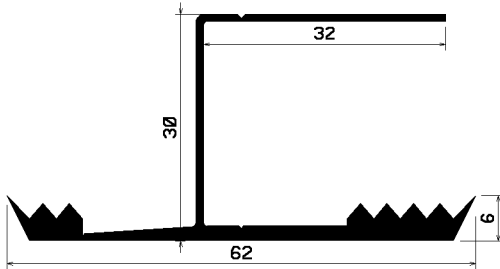

F546
EP/s/1639

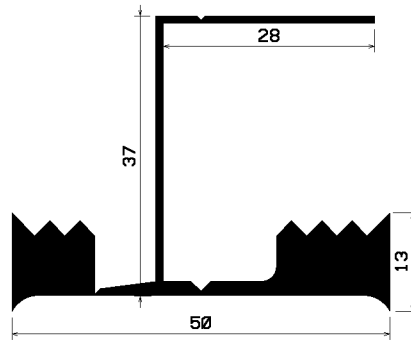

F554
EP/s/1640

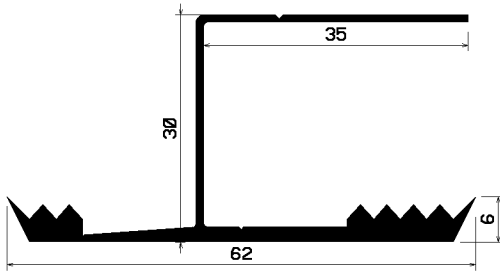

F555
EP/s/1641

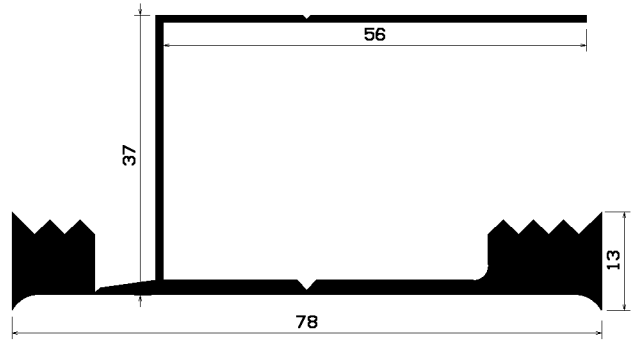

F562
EP/s/1642

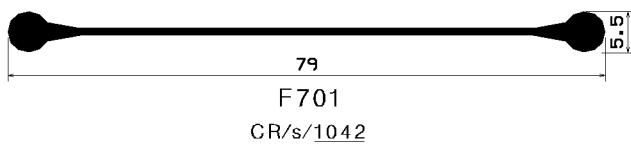
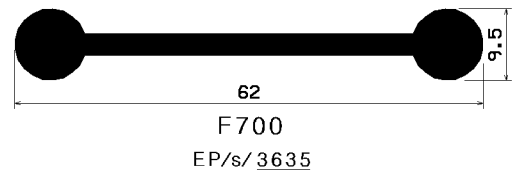
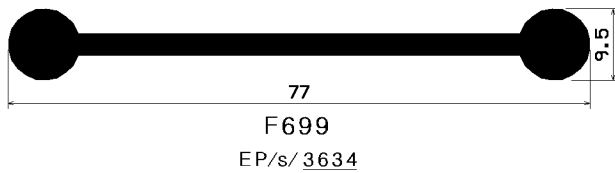
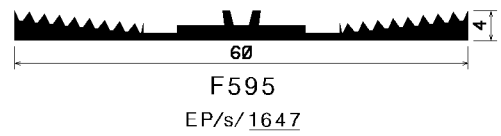
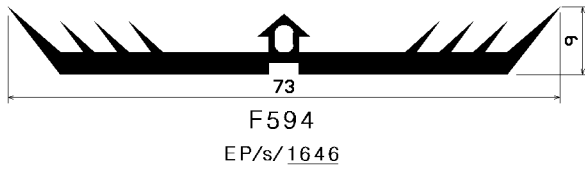
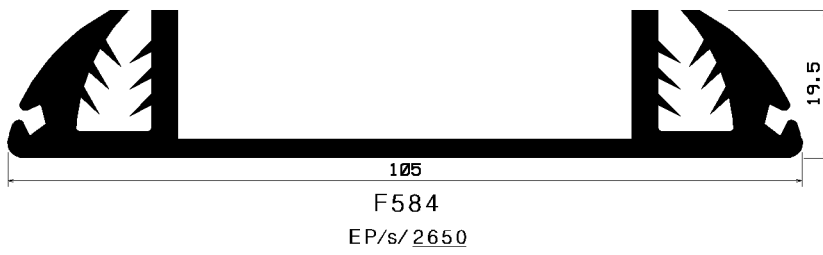
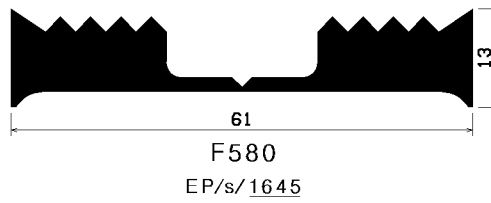
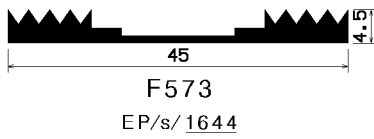
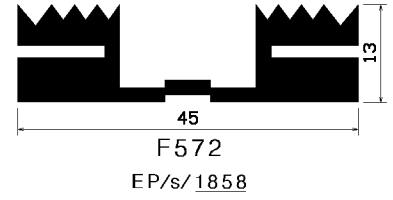
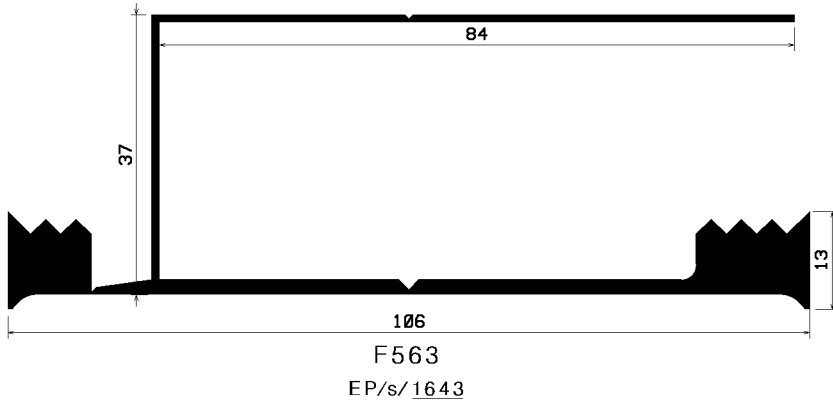

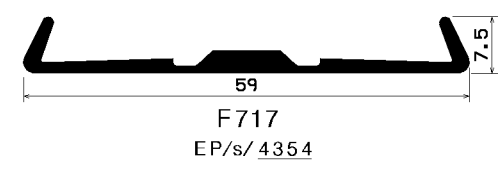
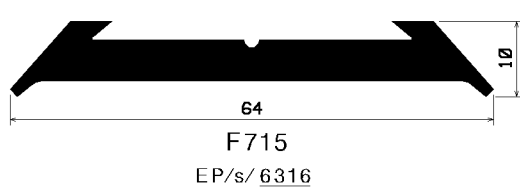
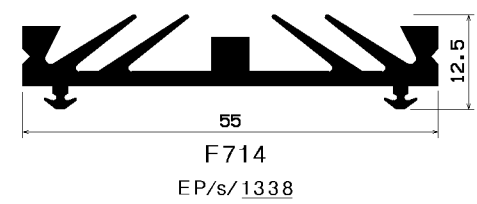
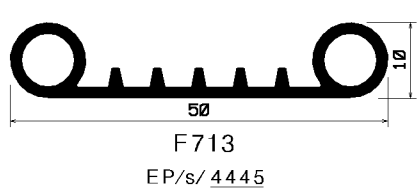
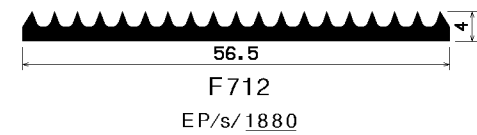
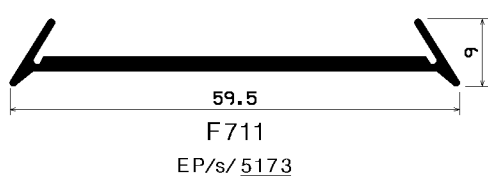
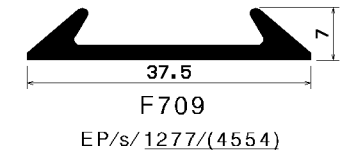
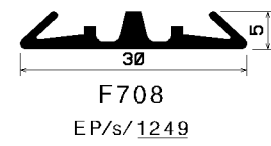
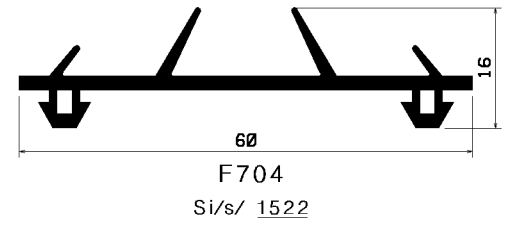
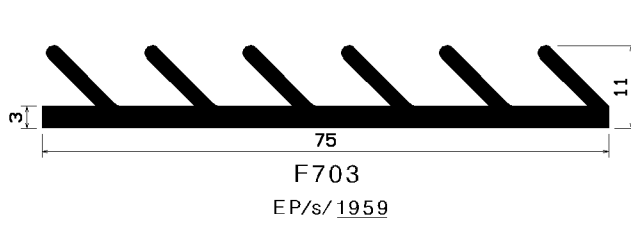
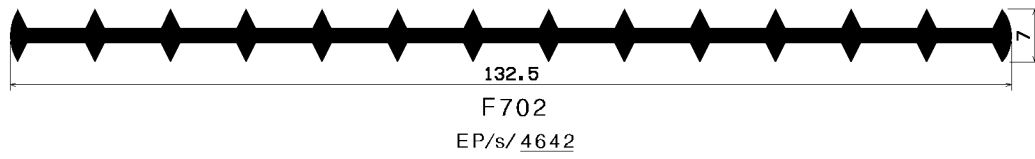



F719
EP/s/ 4794

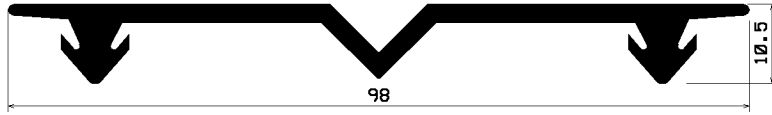

F725
EP/s/ 1575

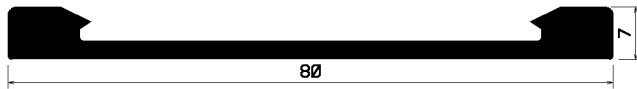

F727
CR/s/ 4355

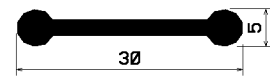

F837
EP/s/ 2851

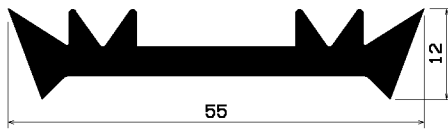

F916
EP/s/ 3110

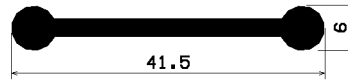

F922
NBR/s/ 3129

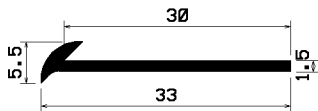

F925
EP/s/ 3139

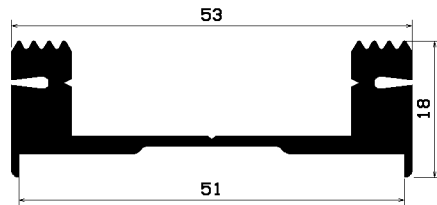

F929
EP/s/ 3150

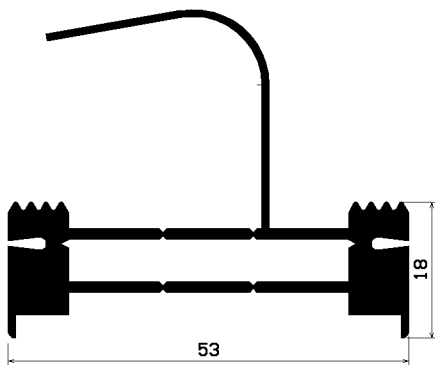

F930
EP/s/ 3171

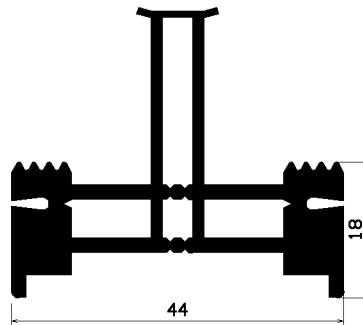

F981
EP/s/ 3308

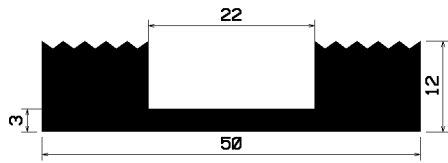

F984
EP/s/3311

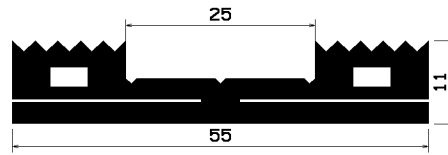

F1140
EP/s/3763

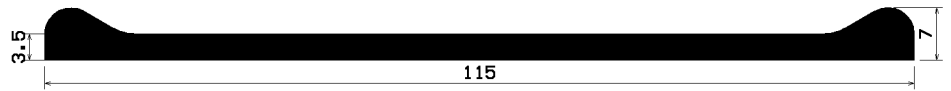

F1244
EP/s/4064

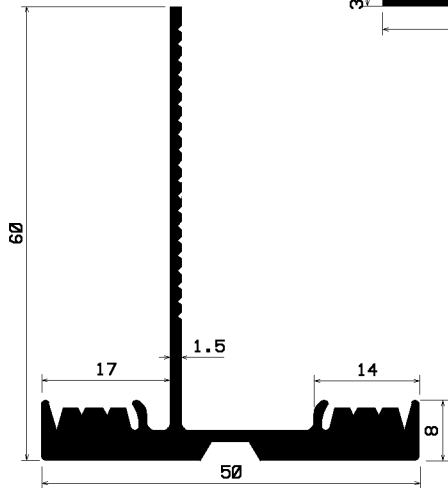

F1246
EP/s/4067

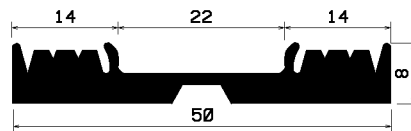

F1247
EP/s/4068

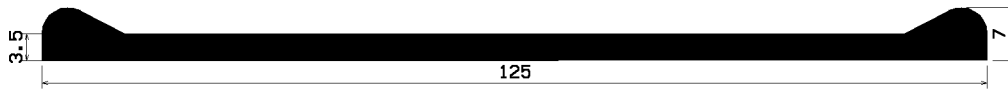

F1271
EP/s/4137

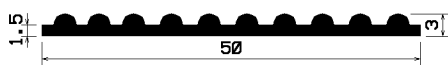

F1287
EP/s/4190

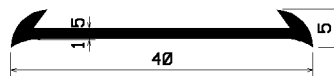

F1294
EP/s/2286

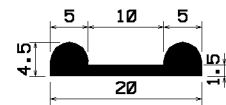

F1313
EP/s/1033

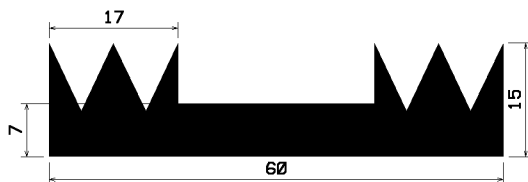

F1359
SBR/s/1292

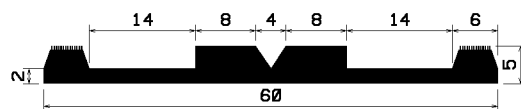

F1387
EP/w/1882

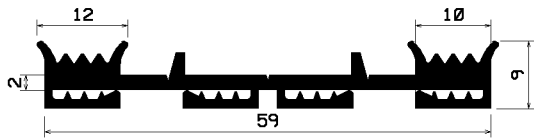

F1410
EP/s/ 4231

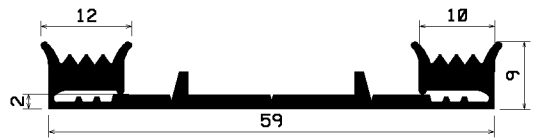

F1411
EP/s/ 4233

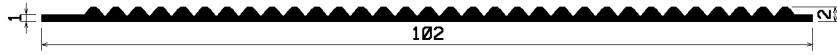

F1420
EP/g/ 4276



F1482
CR/s/ 4627

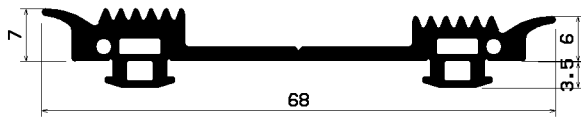

F1551
EP/s/ 4828

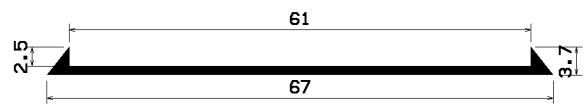

F1553
NBR/s/ 4848

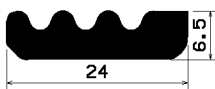

F1558
EP/s/ 4891



F1591
EP/s/ 5215/(5216)

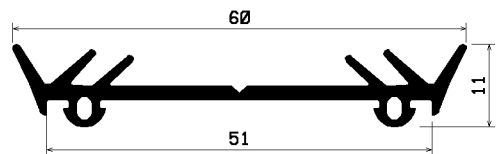

F1667
EP/s/ 5659

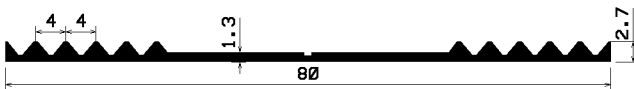

F1771
EP/s/ 6028

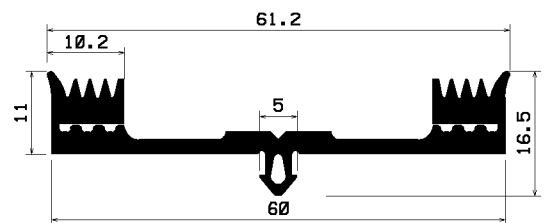

F1905
EP/s/ 6776

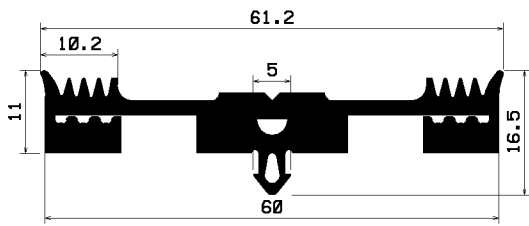

F1906
EP/s/ 6777

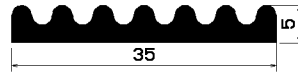

F1923
NBR/s/ 6638

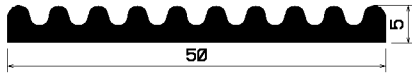

F1925
NBR/s/ 6641

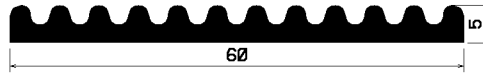

F1926
NBR/s/ 6640

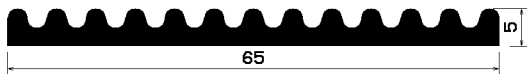

F1927
NBR/s/ 6639

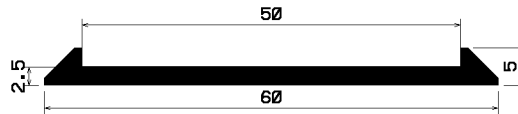

F1937
Si/I/ 6671

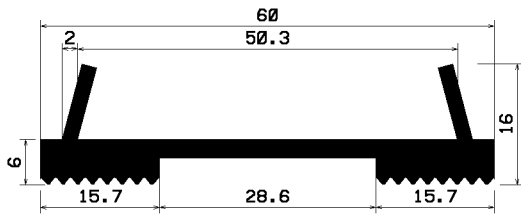

F2005
EP/s/ 7007

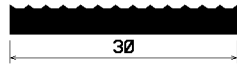

F2171
EP/s/ 7619

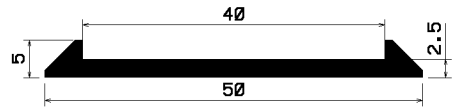

F2172
EP/s/ 7623

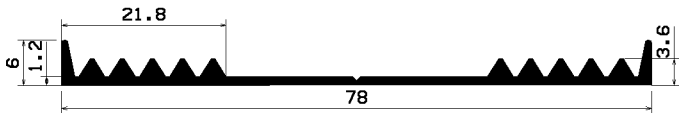

F2174
EP/s/ 7634

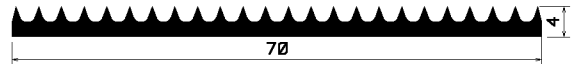

F2248
EP/g/ 7853

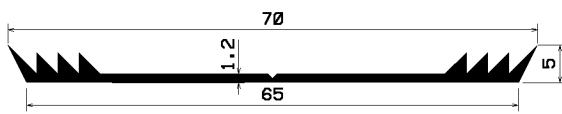

F2276
EP/s/ 7962

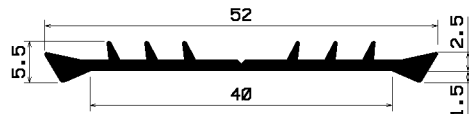

F2458
EP/s/ 7423

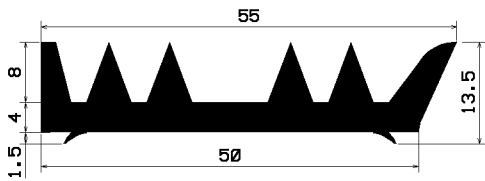

F2468
EP/s/ 7449