

gummi-plast

Schild GmbH & Co.KG

Gernsheim



**Profiles of rubber, sponge rubber,
silicone, foam silicone**

D-64579 Gernsheim - Germany

Otto-Hahn-Straße 12

Telefon +49 (0) 62 58 / 932250

Telefax +49 (0) 62 58 / 4997

e-mail: schild@gummi-plast.de

internet: <http://www.gummi-plast.de>

flag- or note- profiles

list no. 638

FN

Legend

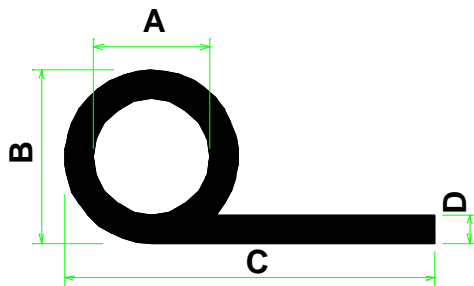

FN9999

means

Profile-No.

EP / s / 9999 / (9998)

means *Quality / Colour / Article-No. / (Article-No. with sa)*

sa = self adhesive

Quality

CR	Neoprene
EP	APTK/EPDM
NBR	Perbunan
NK	Natural rubber
Si	Silicone
SPS	Foam silicone
FPM	VITON®
PVC	Soft-PVC
EVA	Ethylenvinylacetat
SBR	Buna (Styrol-Butadien)

Colours

s	black
g	grey
w	white
az	anthracite
bg	beige
br	brown
hg	light-grey
rb	red-brown
t	translucent
r	red
x	colour selectable

â = Entered registered trade mark of the company DuPont

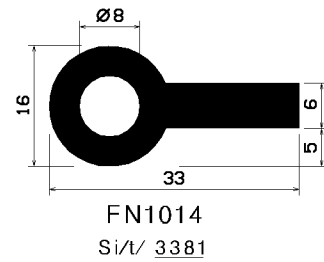
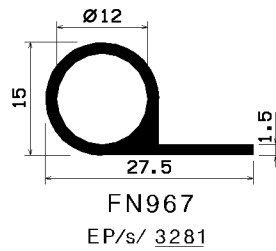
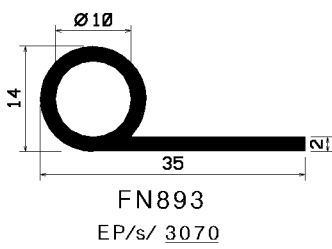
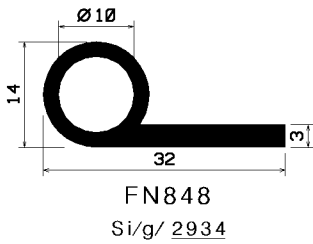
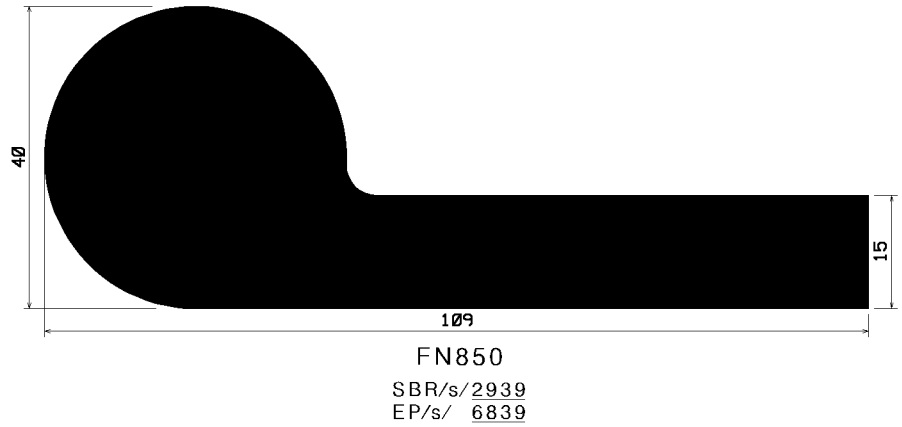
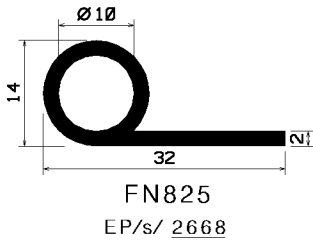
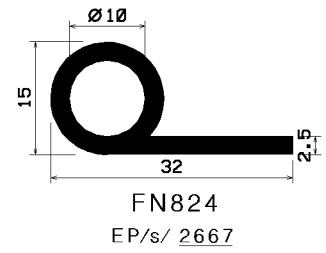
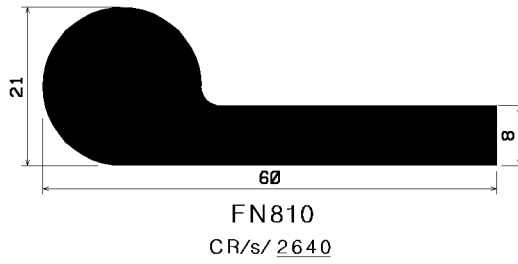
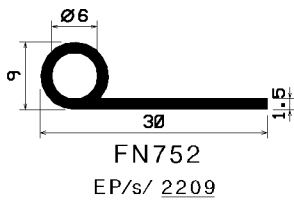
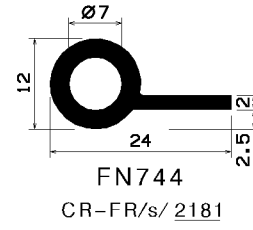
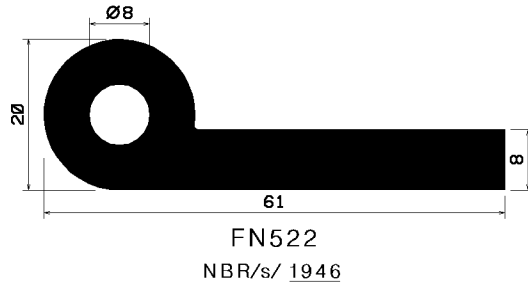
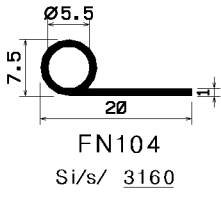

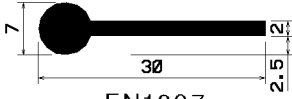

FN1097
EP/g/ 3624

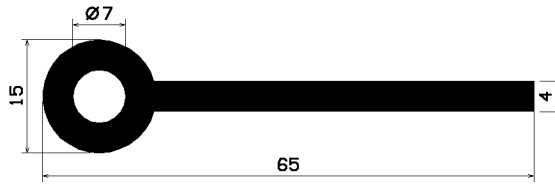

FN1129
EP/s/ 3725

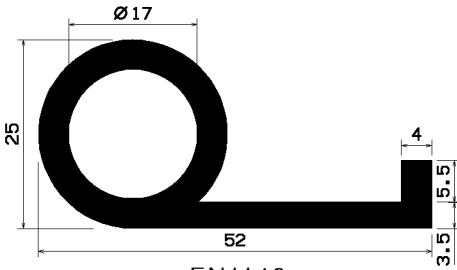

FN1149
EP/s/ 3799

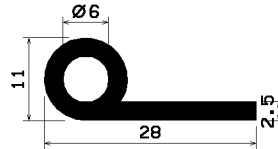

FN1150
CR-FR/s/ 3800

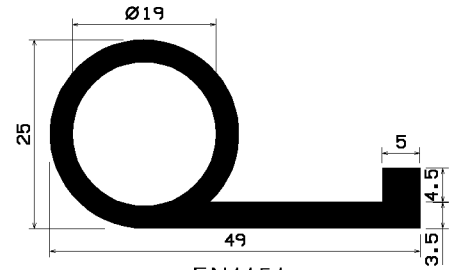

FN1151
EP/s/ 3804

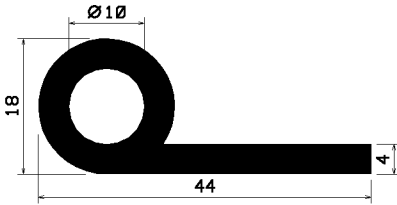

FN1168
EP/s/ 3853

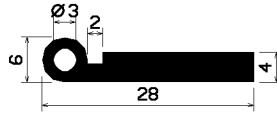

FN1183
NBR/s/ 3918

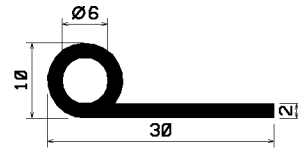

FN1205
Si/ / 3955

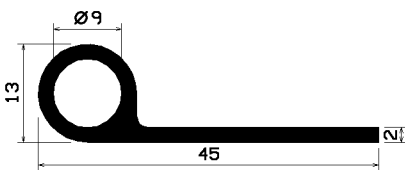

FN1232
NBR/s/4039

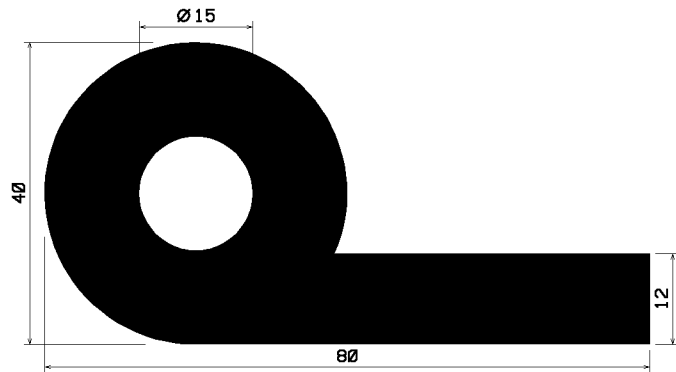

FN1235
EP/s/ 4037

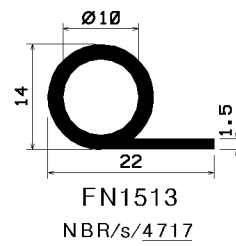
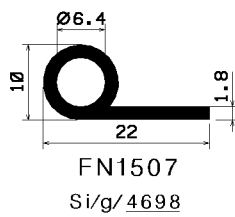
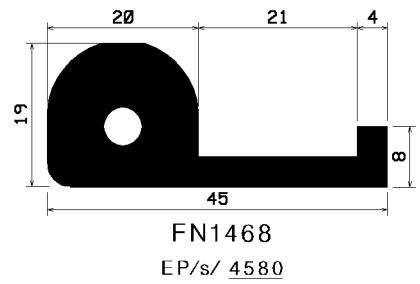
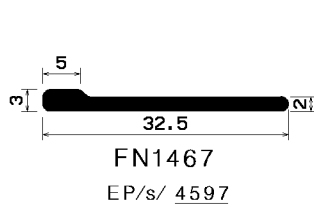
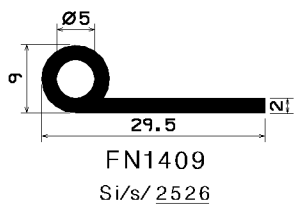
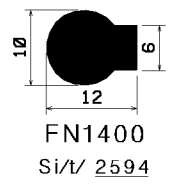
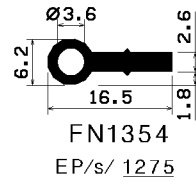
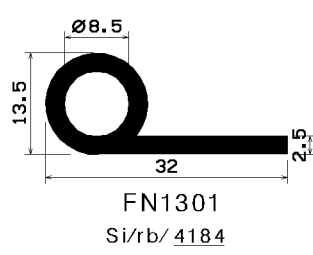
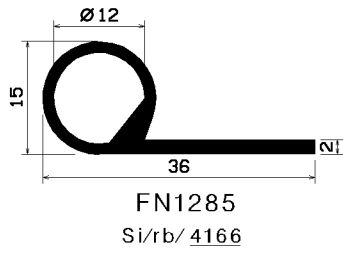
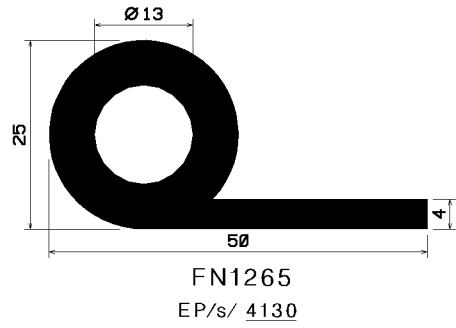
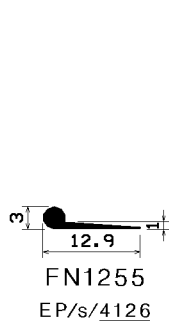
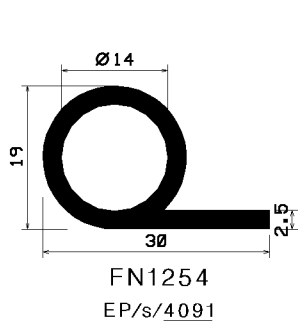
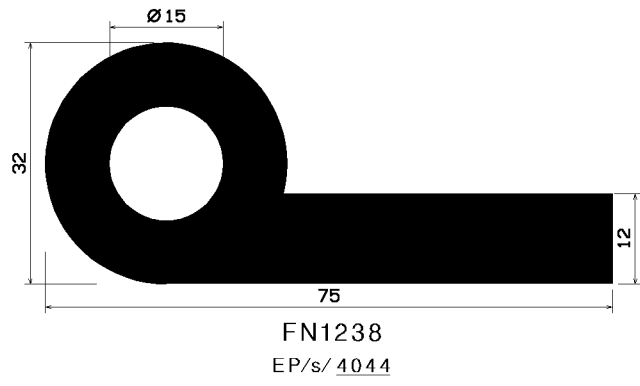
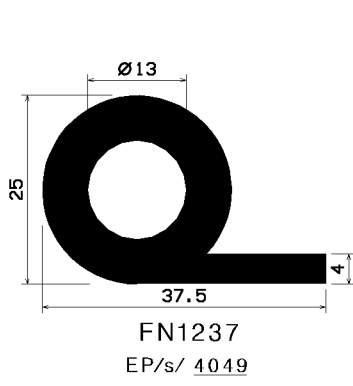

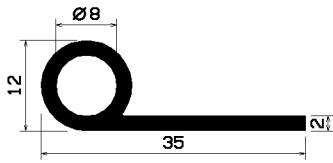

FN1525
EP/s/ 5725

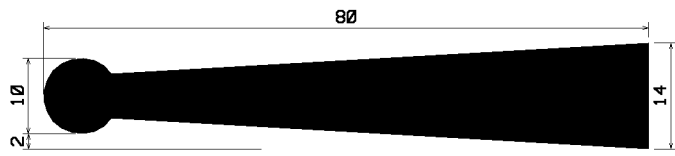

FN1534
EP/s/ 4760

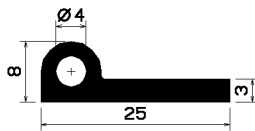

FN1596
Si/rb/ 5294

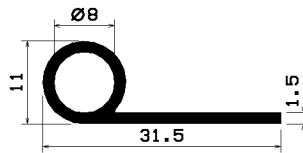

FN1604
EP/s/ 5237
NK/s/5274

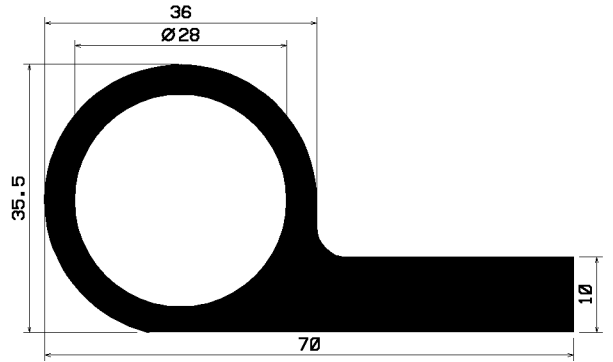

FN1615
Si/t/ 5328

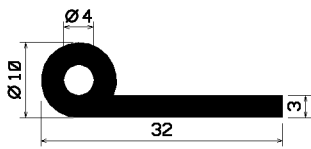

FN1624
Si/s/ 5364

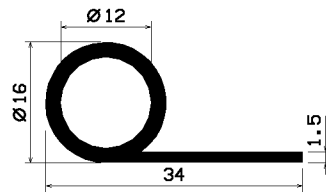

FN1625
Si/rb/ 5370

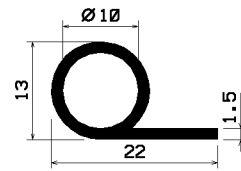

FN1730
Si/rb/ 5935

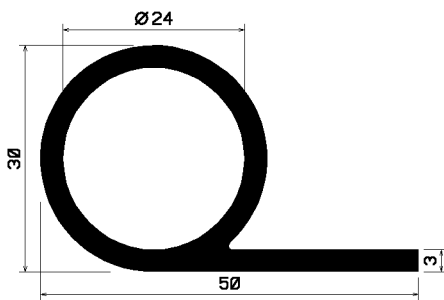

FN1750
FPM/s/ 5977

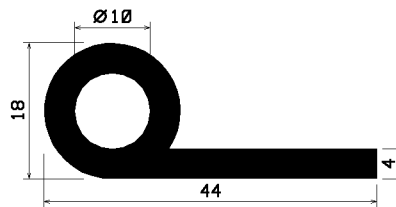

FN1770
NBR/s/ 6031

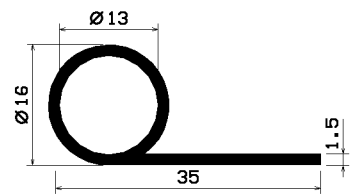

FN1812
Si/t/ 6152

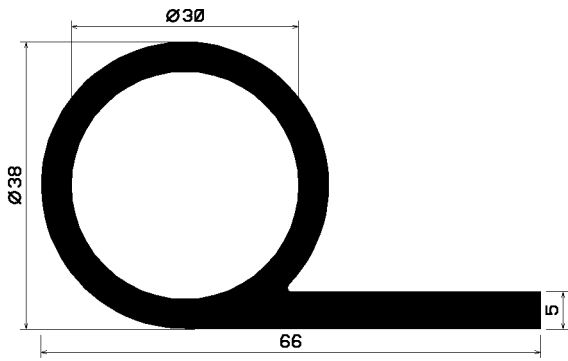

FN1817
Si/g/ 6143

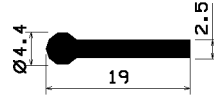

FN1818
EP/w/6159

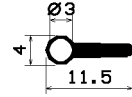

FN1856
Si/s/ 6429

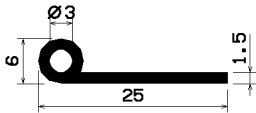

FN1865
EP/s/ 6617

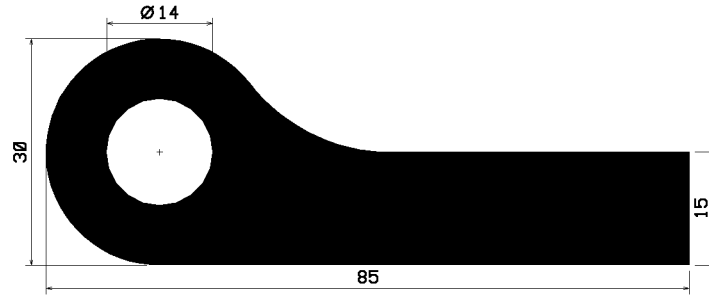

FN1869
EP/s/ 6516

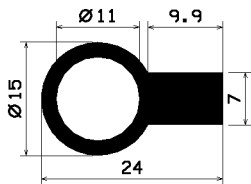

FN1880
Si/rb/ 6563

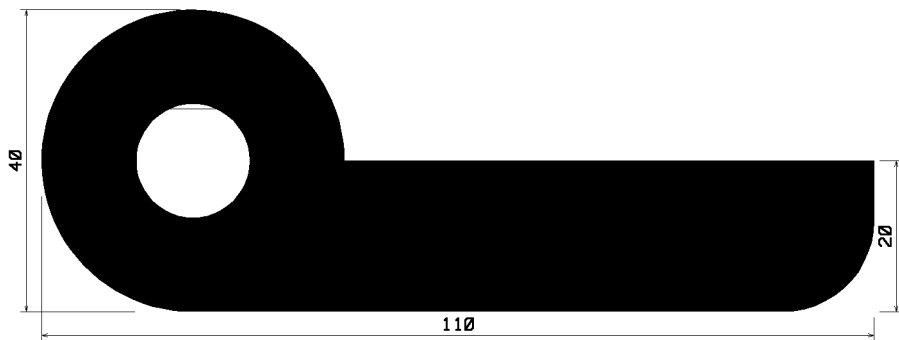

FN1892
CR/s/ 6620

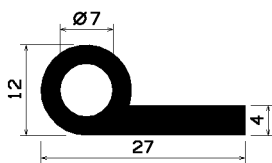

FN1914
Si/t/ 6798

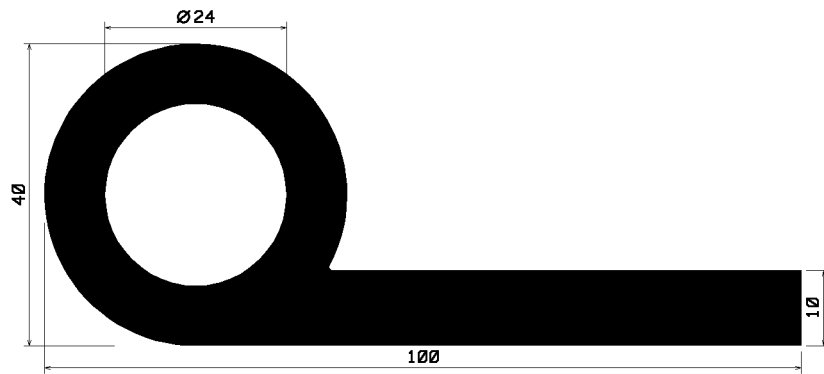

FN1918
EP/s/ 6822

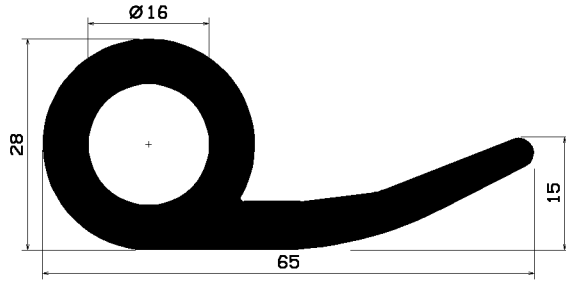

FN1929
EP/s/ 6818

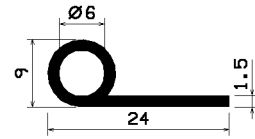

FN1936
EP/s/ 6648

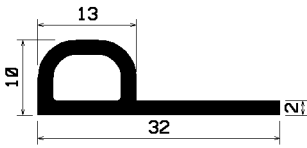

FN1956
NBR/s/ 6860

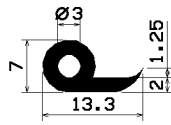

FN1967
Si/I/ 6866

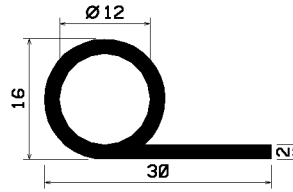

FN1976
Si/I/ 6917

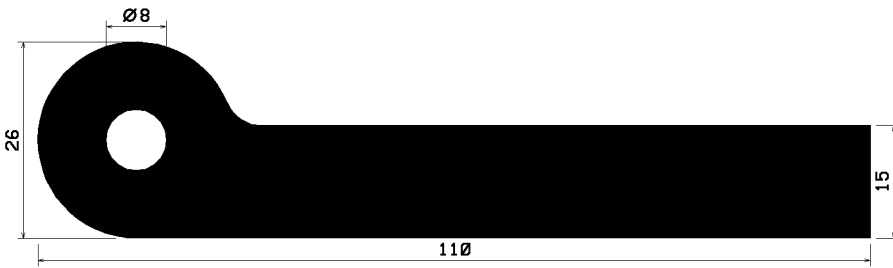

FN2004
EP/s/ 7006

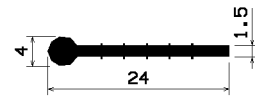

FN2039
EP/s/ 7090

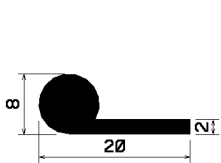

FN2090
Si/I/ 7244

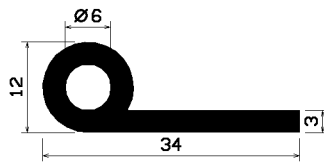

FN2104
Si/w/7281

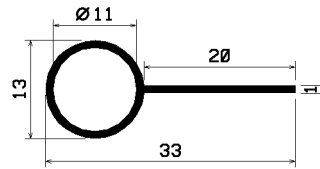

FN2128
EP/s/ 7331

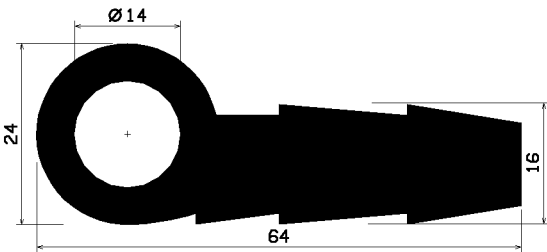

FN2159
NBR/s/ 7594

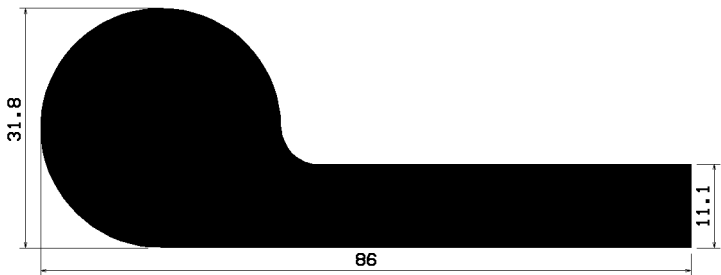

FN2165
EP/s/ 7607

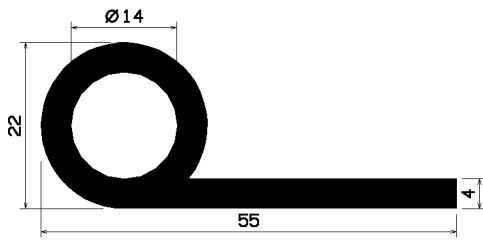

FN2181
EP/s/ 7629

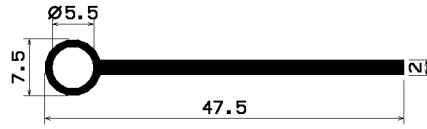

FN2182
EP/s/ 7628

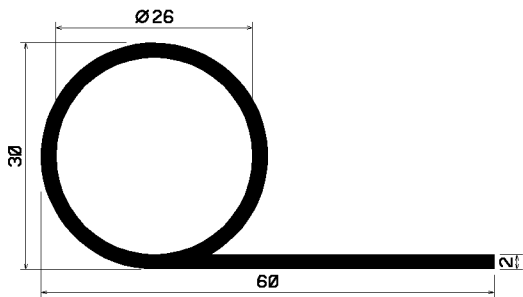

FN2186
EP/s/ 7650

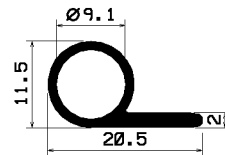

FN2203
Si/br/ 7684

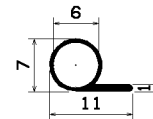

FN2206
Si/br/ 7693

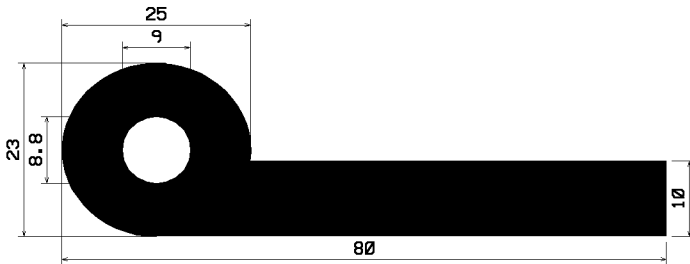

FN2209
EP/s/ 7695

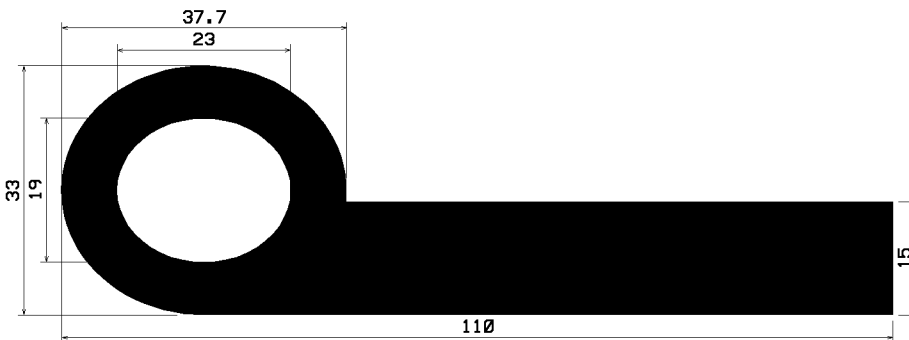

FN2229
EP/s/ 7821

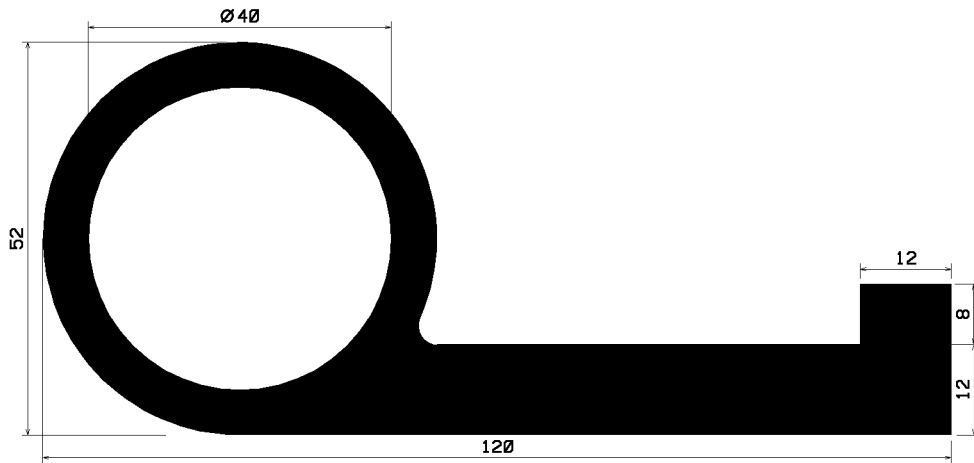

FN2251
EP/s/7862

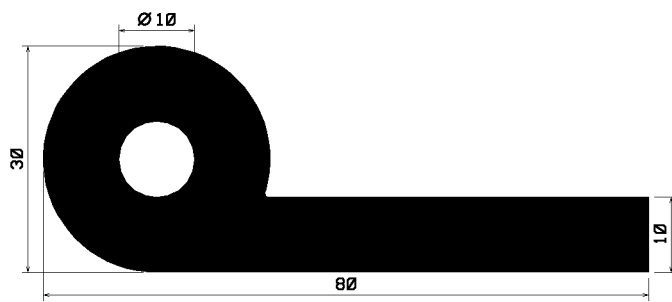

FN2253
FPM/s/7863

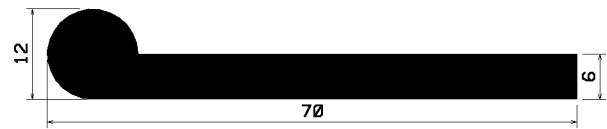

FN2255
EP/s/7873

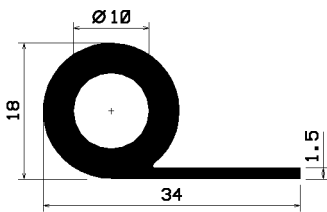

FN2256
Si/w/7892

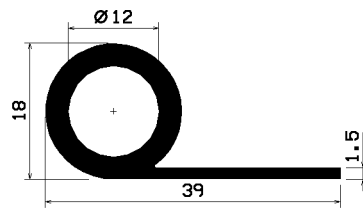

FN2268
Si/w/7952

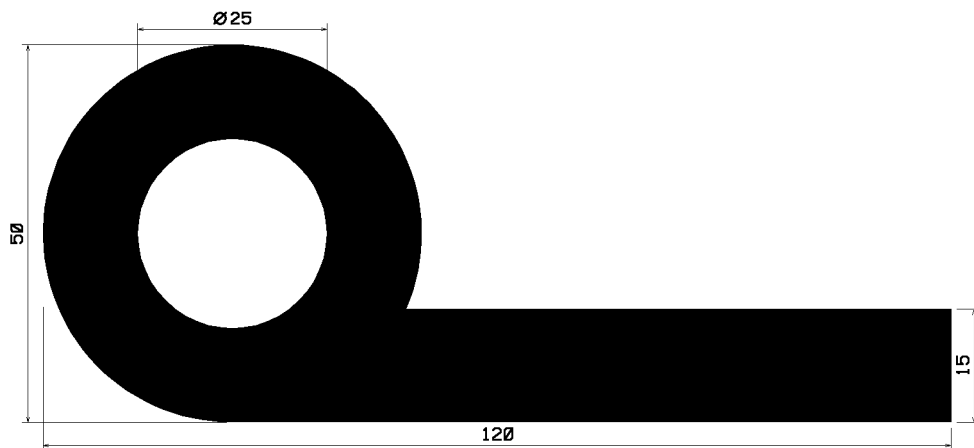

FN2295
NR/SBR/s/7996

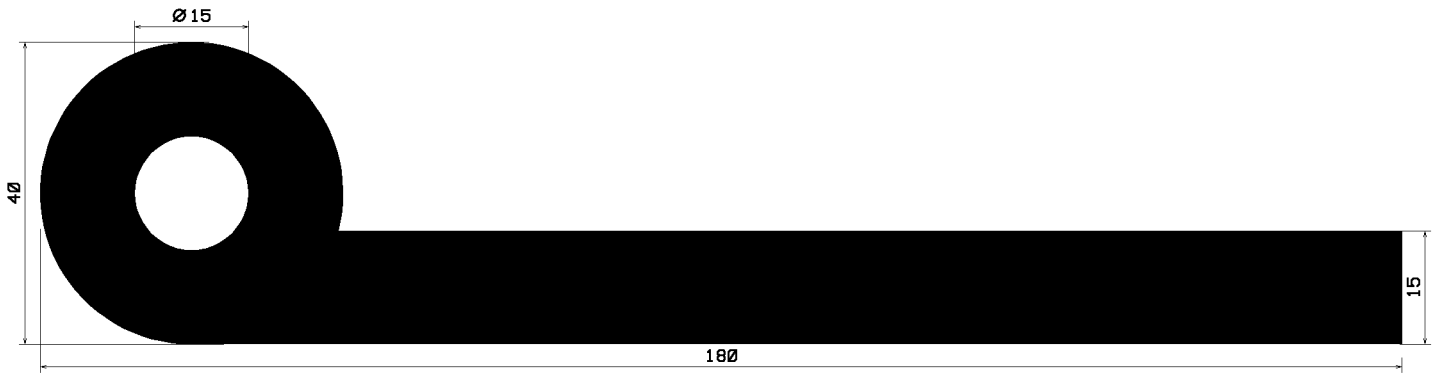

FN2296
NR/SBR/s/ 7995

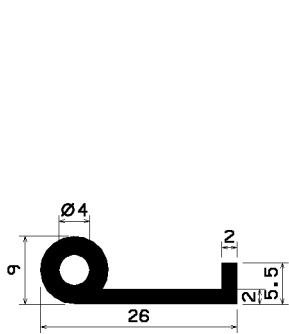

FN2307
FPM/s/ 8063

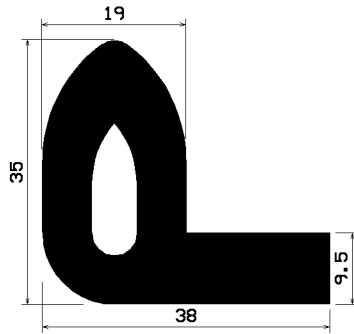

FN2321
EP/s/ 8076

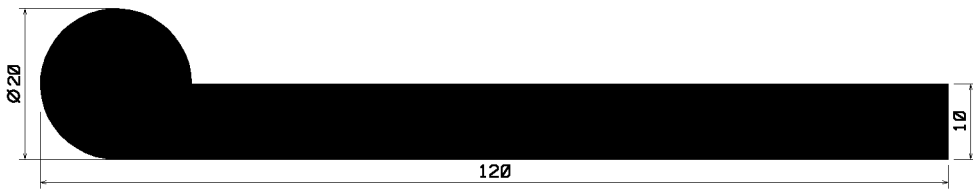

FN2334
EP/s/ 8113

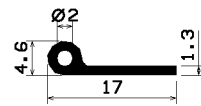

FN2340
EP/s/ 8132

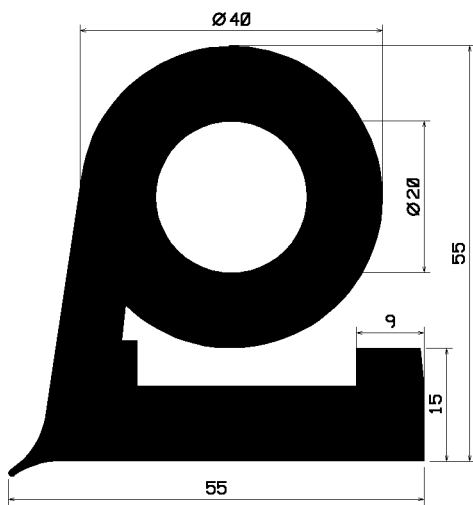

FN2346
EP/s/ 8133

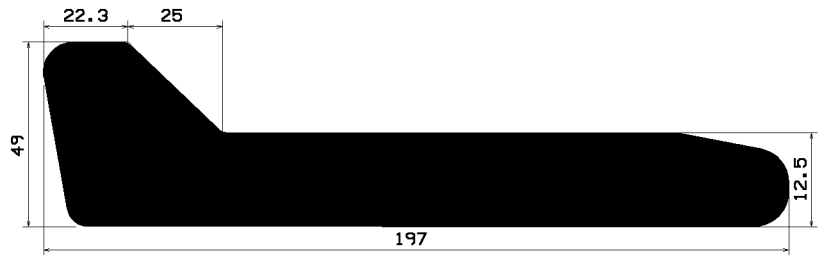

M. 1:2
FN2364
EP/s/ 8190

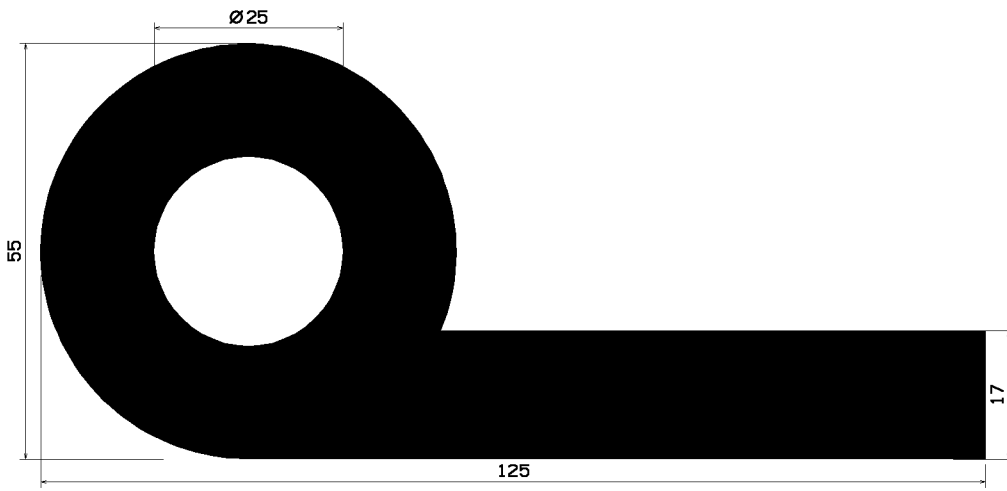

FN2368
EP/s/ 8196

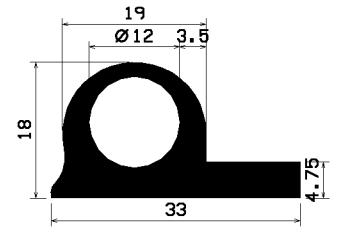

FN2377
EP/s/ 8213

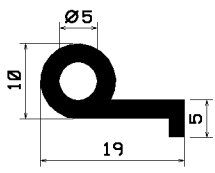

FN2395
Si/rb/ 8266

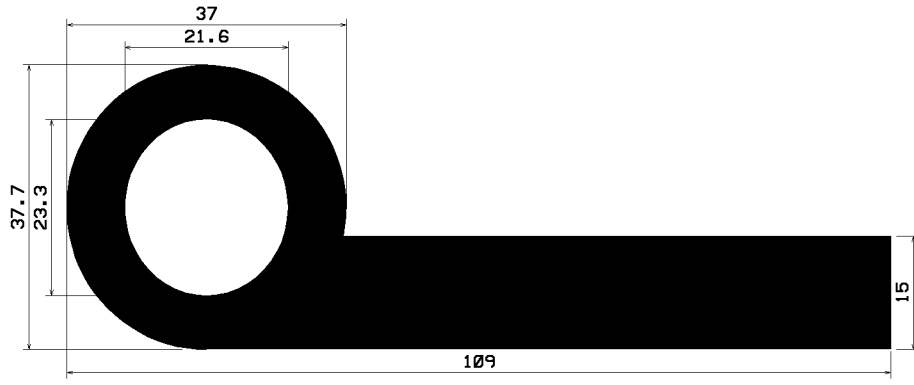

FN2399
EP/s/ 8258

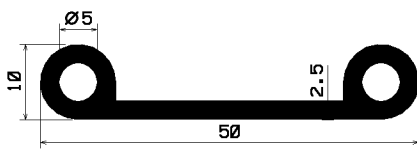

FN2401
EP/s/ 8264

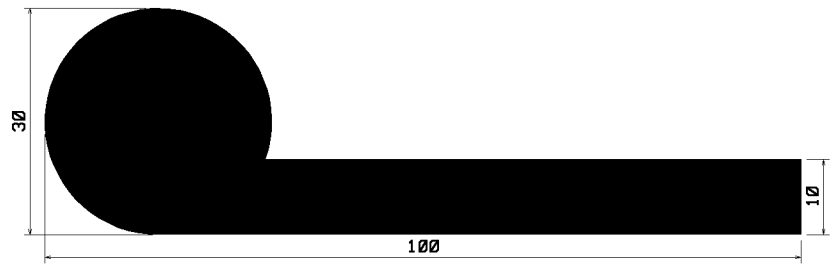

FN2439
EP/s/ 7405

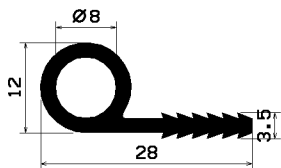

FN2454
Si/rb/ 7420

Sponge rubber

Legend

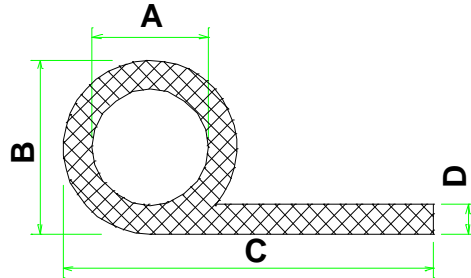

25999

means

Profile-No.

EP / s / 9999 / (9998)

means

Quality / Colour / Article-No. / (Article-No. with sa)

sa = self adhesive

Quality

CR	Neoprene
EP	APTK/EPDM
NBR	Perbunan
NK	Natural rubber
Si	Silicone
SPS	Foam silicone
FPM	VITON®
PVC	Soft-PVC
EVA	Ethylenvinylacetat
SBR	Buna (Styrol-Butadien)

Colours

s	black
g	grey
w	white
az	anthracite
bg	beige
br	brown
hg	light-grey
rb	red-brown
t	translucent
r	red
x	colour selectable

â = Entered registered trade mark of the company DuPont

Sponge rubber

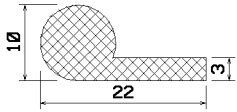

25003
EP/s/ 0261

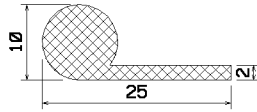

25004
EP/s/ 0262/(4464)

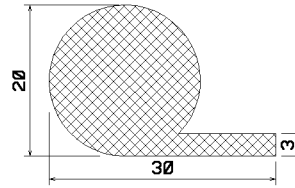

25027
NBR/s/ 0287

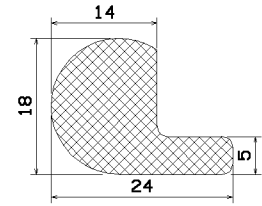

25034
EP/s/ 0293

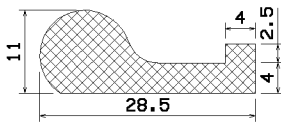

25056
EP/s/ 0314

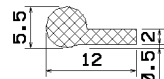

25069
EP/s/ 0325

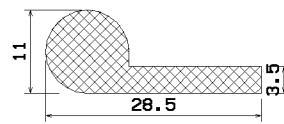

25095
EP/s/ 0349

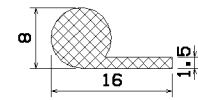

25124
EP/s/ 0377

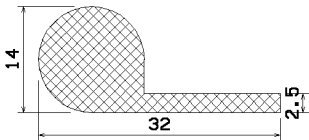

25208
EP/s/ 2168
EP/g/ 2754

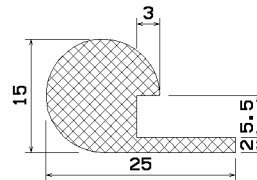

25210
EP/g/ 2208

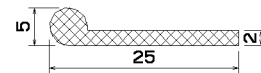

25224
EP/s/ 2863/(4348)

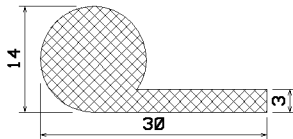

25241
EP/s/ 3012/(3766)
EP/g/ 3006

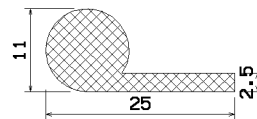

25242
EP/g/ 3002

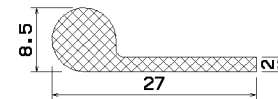

25270
EP/s/ 3173
EP/g/ 3184

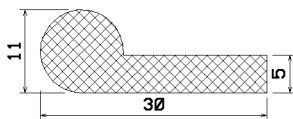

25274
EP/g/ 3231

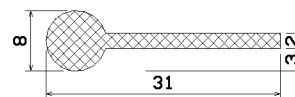

25329
EP/g/ 3652

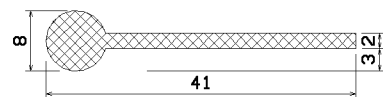

25352
EP/g/ 2998

Sponge rubber

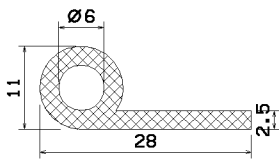

25362
CR/s/ 3877

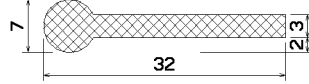

25398
EP/s/ 4161

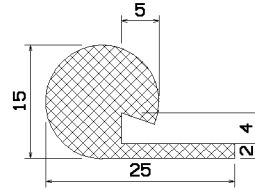

25438
EP/g/ 1309

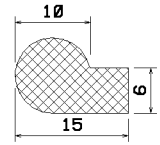

25450
NBR/g/ 1985

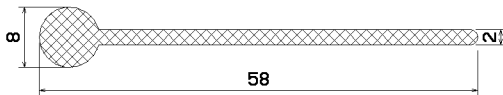

25466
EP/s/ 4211

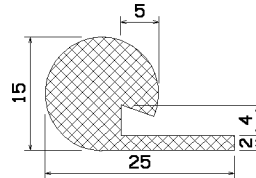

25472
EP/g/4267

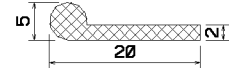

25483
EP/s/ 4378/(4379)

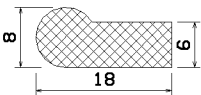

25544
EP/g/5048
CR/s/5049

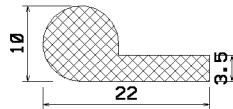

25545
EP/s/5050

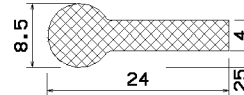

25546
EP/s/ 5051

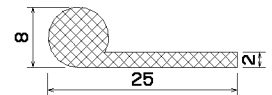

25547
NK/g/ 5052

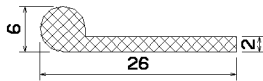

25548
NK/g/ 5053

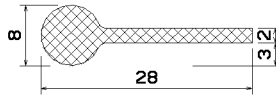

25549
EP/s/ 5054

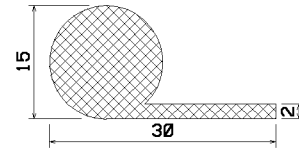

25550
NK/g/5055

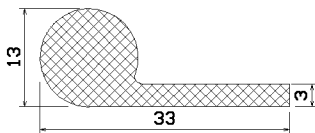

25551
CR/s/5056

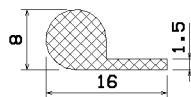

25645
EP/g/ 4674

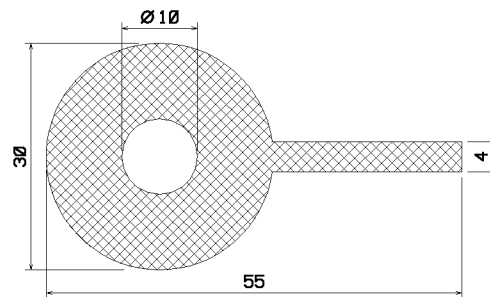

25793
NBR/hg/ 8069