

---

---

# gummi-plast

---

---

Schild GmbH & Co.KG

Gernsheim



**Profile aus Gummi, Moosgummi,  
Silikon, Schaum silikon**

D-64579 Gernsheim

Otto-Hahn-Straße 12

Telefon 0 62 58 / 932250

Telefax 0 62 58 / 4997

e-mail: [schild@gummi-plast.de](mailto:schild@gummi-plast.de)

internet: <http://www.gummi-plast.de>

# Fahnen- (Noten)- Profile Liste Nr. 638

**FN**

# Vollgummi

---

## Zeichenerklärung

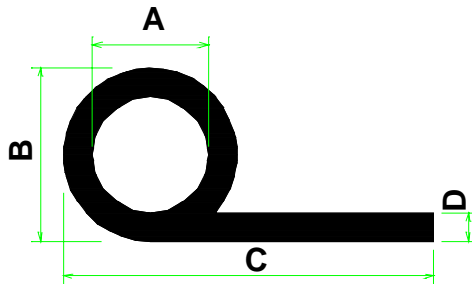

**FN 9999**

**bedeutet**

*Profil-Nr.*

**EP / s / 9999**

**bedeutet**

*Qualität / Farbe / Artikel-Nr.*

### Qualität

CR	Neoprene
EP	EPDM
NBR	Perbunan
NK	Naturkautschuk
Si	Silikon
SPS	Silikonschaum
FPM	VITON®
PVC	Weich-PVC
EVA	Ethylenvinylacetat
SBR	Buna (Styrol-Butadien)
...-FR	selbst verlöschend

### Farbe

s	schwarz
g	grau
w	weiß
az	anthrazit
bg	beige
br	braun
hg	hellgrau
rb	rotbraun
t	transparent
r	rot
x	Farbe wählbar

# Vollgummi bzw. Weich-PVC

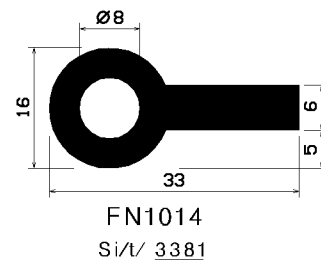
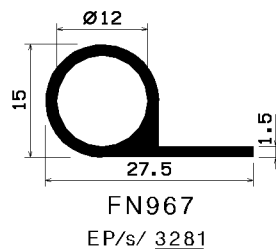
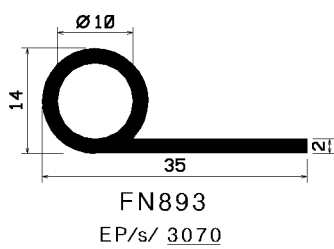
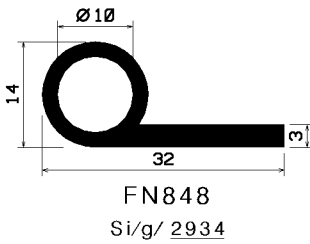
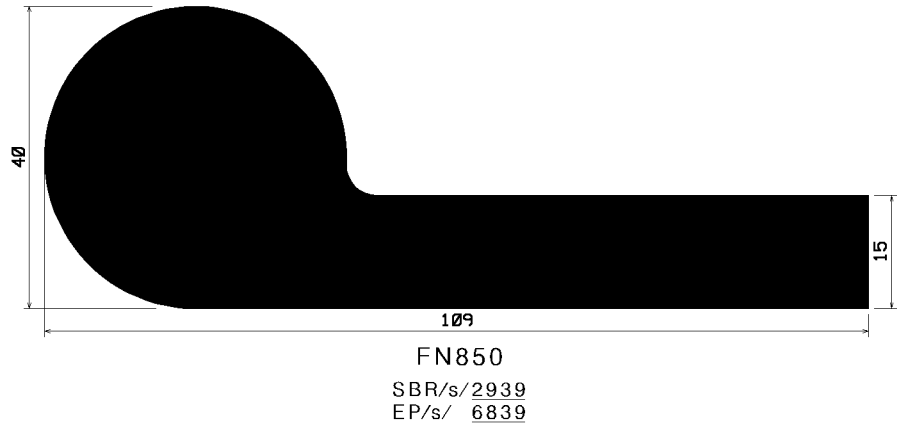
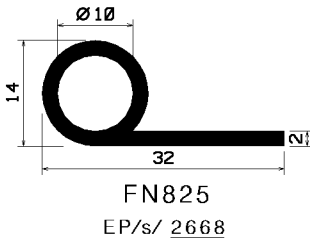
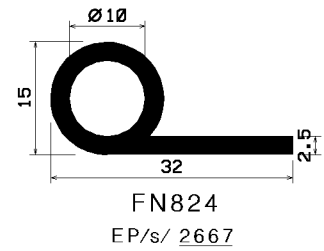
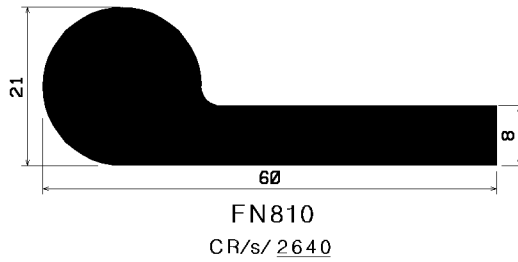
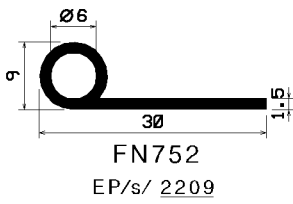
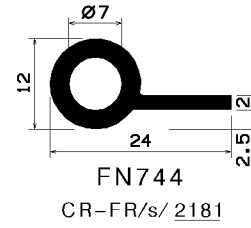
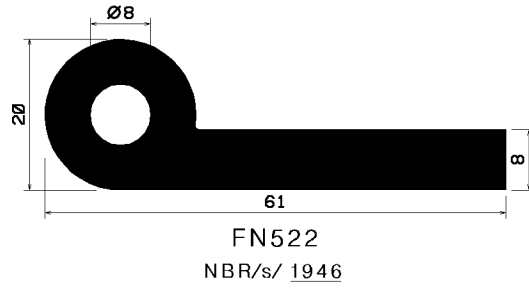
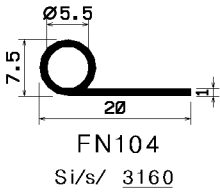

# Vollgummi bzw. Weich-PVC

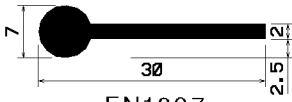

FN1097  
EP/g/ 3624

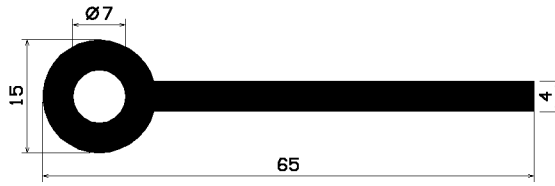

FN1129  
EP/s/ 3725

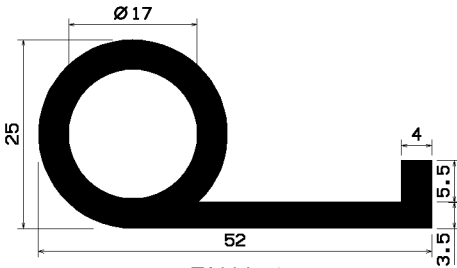

FN1149  
EP/s/ 3799

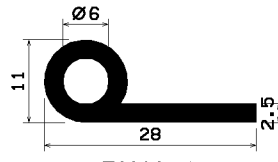

FN1150  
CR-FR/s/ 3800

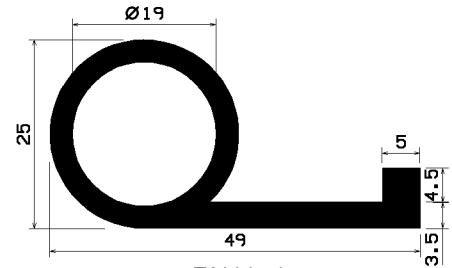

FN1151  
EP/s/ 3804

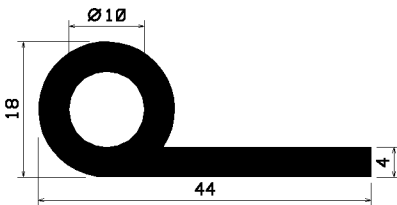

FN1168  
EP/s/ 3853

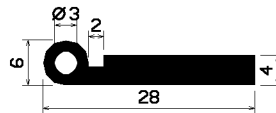

FN1183  
NBR/s/ 3918

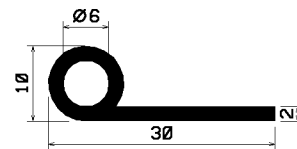

FN1205  
Si/ / 3955

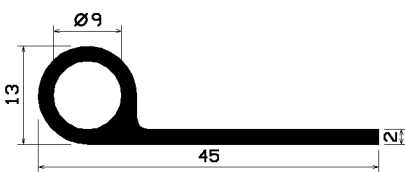

FN1232  
NBR/s/4039

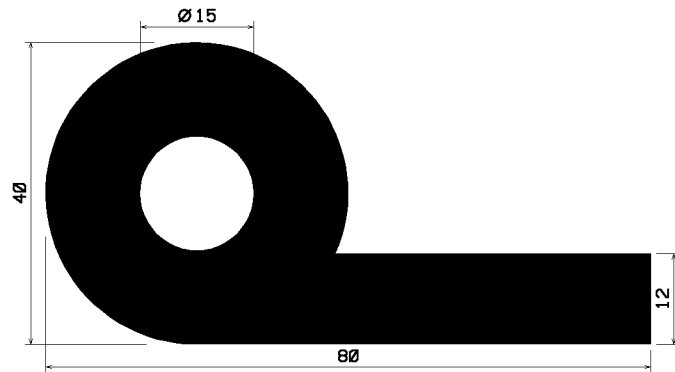

FN1235  
EP/s/ 4037

# Vollgummi bzw. Weich-PVC

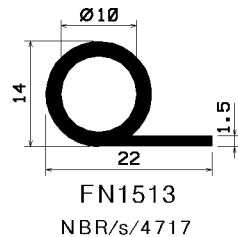
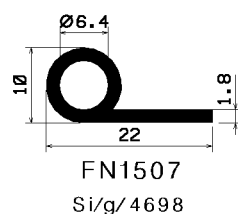
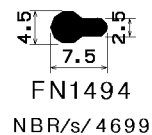
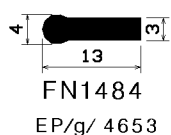
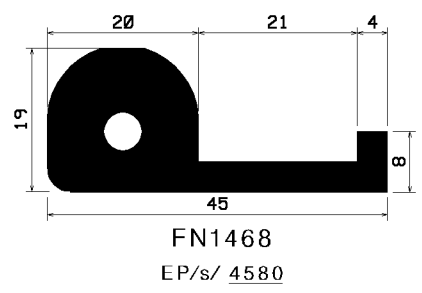
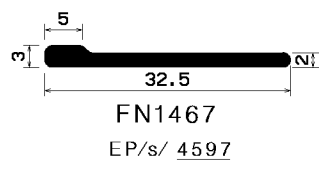
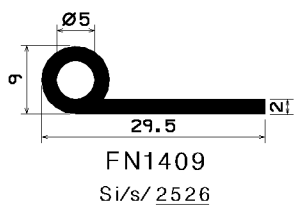
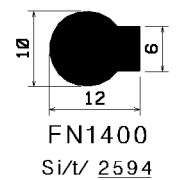
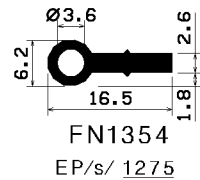
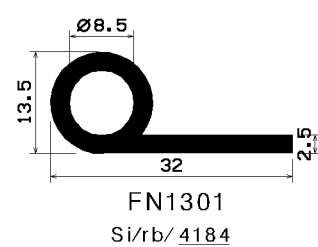
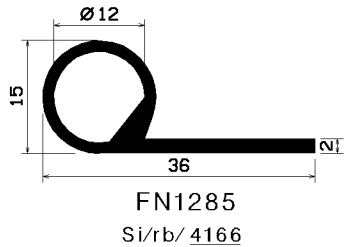
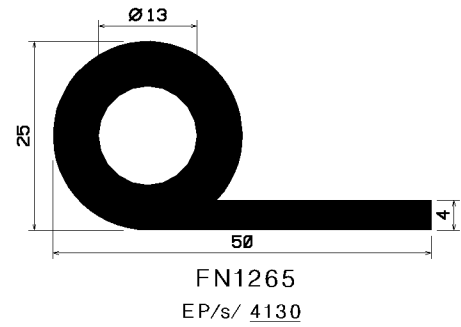
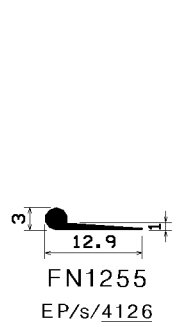
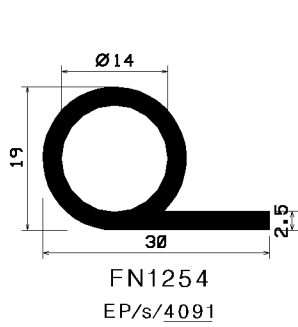
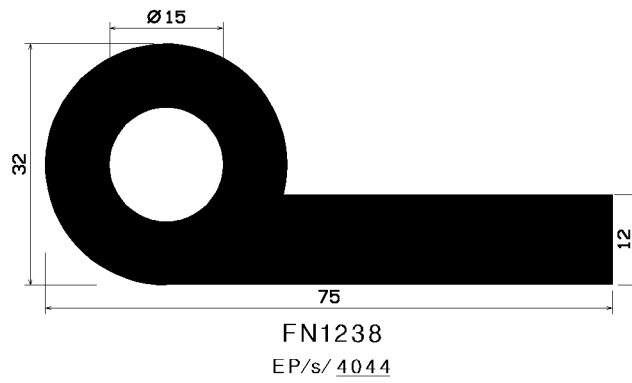
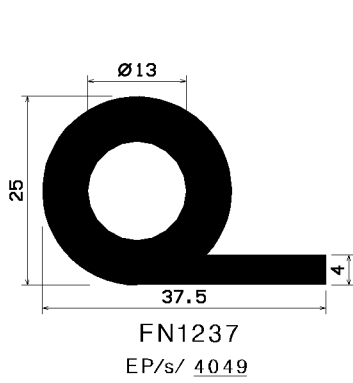

# Vollgummi bzw. Weich-PVC

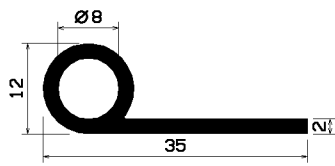

FN1525  
EP/s/ 5725

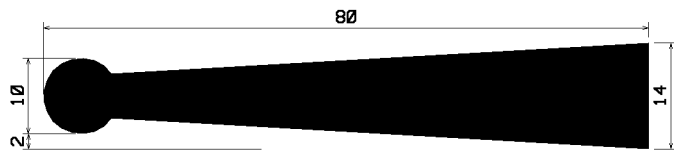

FN1534  
EP/s/ 4760

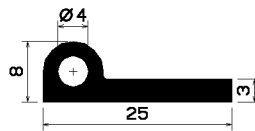

FN1596  
Si/rb/ 5294

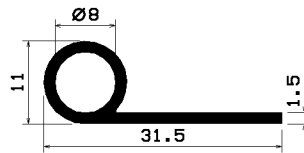

FN1604  
EP/s/ 5237  
NK/s/5274

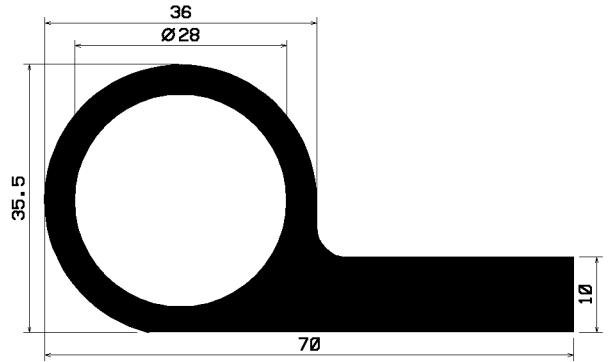

FN1615  
Si/t/ 5328

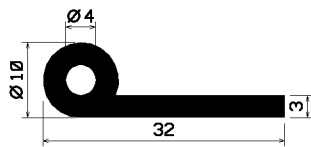

FN1624  
Si/s/ 5364

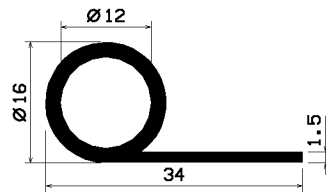

FN1625  
Si/rb/ 5370

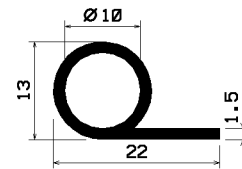

FN1730  
Si/rb/ 5935

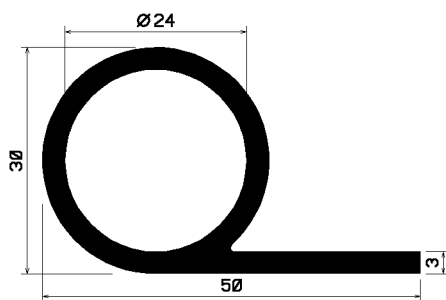

FN1750  
FPM/s/ 5977

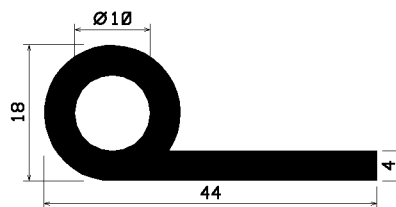

FN1770  
NBR/s/ 6031

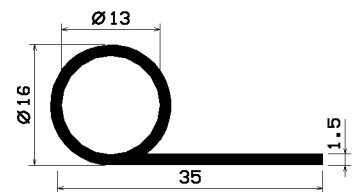

FN1812  
Si/t/ 6152

# Vollgummi bzw. Weich-PVC

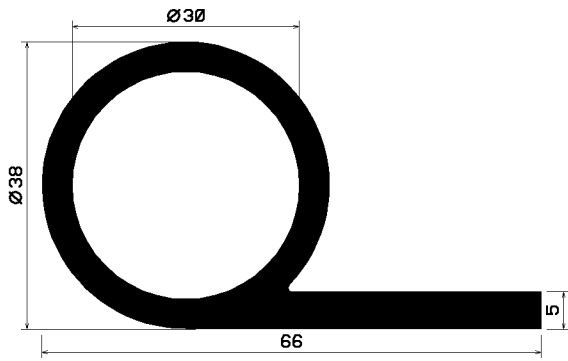

FN1817  
Si/g/ 6143

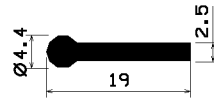

FN1818  
EP/w/6159

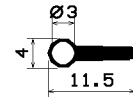

FN1856  
Si/s/ 6429

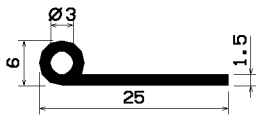

FN1865  
EP/s/ 6617

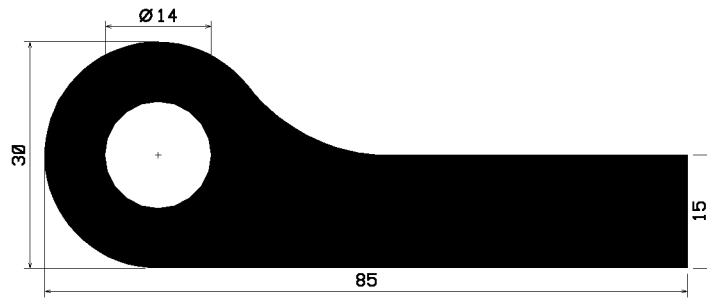

FN1869  
EP/s/ 6516

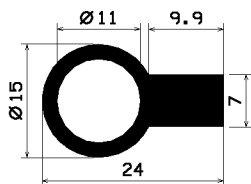

FN1880  
Si/rb/ 6563

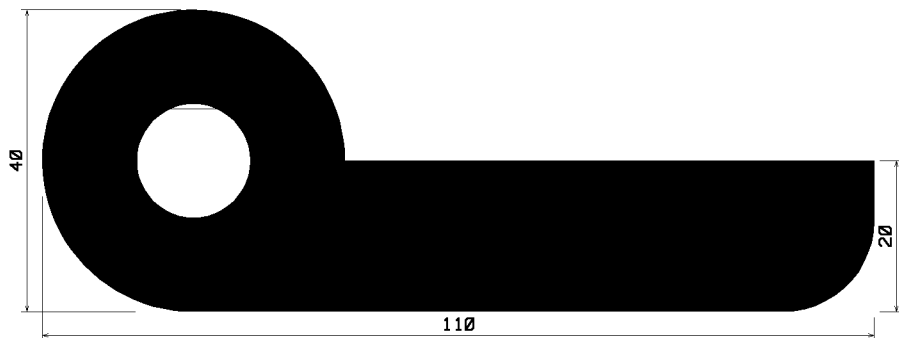

FN1892  
CR/s/ 6620

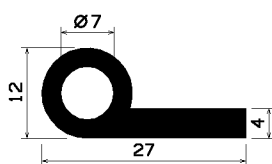

FN1914  
Si/t/ 6798

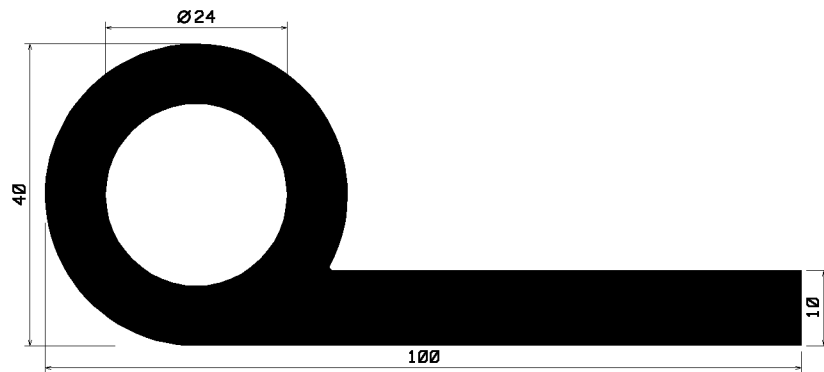

FN1918  
EP/s/ 6822

# Vollgummi bzw. Weich-PVC

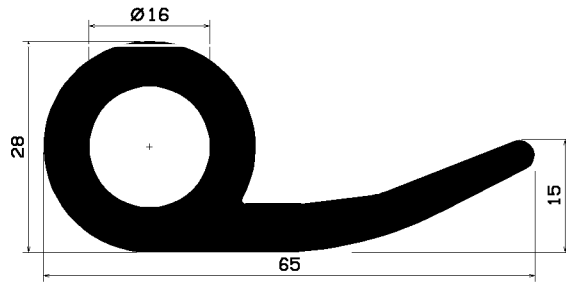

FN1929  
EP/s/ 6818

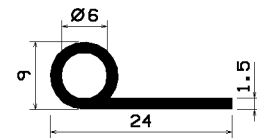

FN1936  
EP/s/ 6648

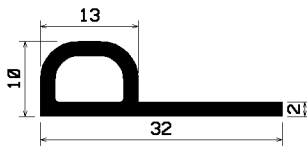

FN1956  
NBR/s/ 6860

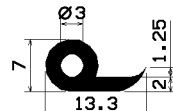

FN1967  
Si/I/ 6866

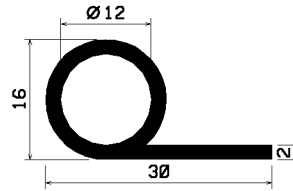

FN1976  
Si/I/ 6917

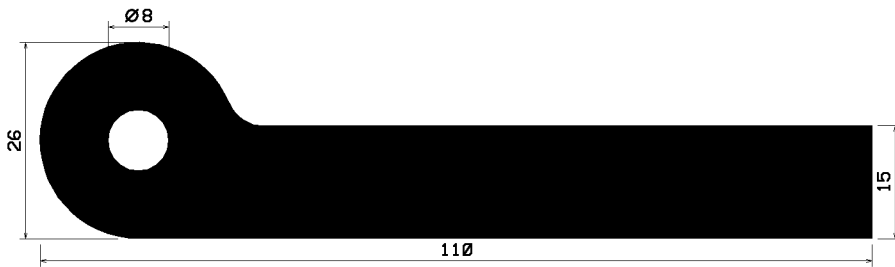

FN2004  
EP/s/ 7006

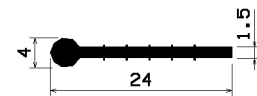

FN2039  
EP/s/ 7090

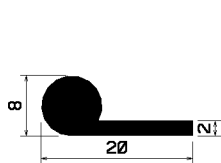

FN2090  
Si/I/ 7244

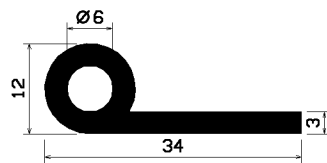

FN2104  
Si/w/7281

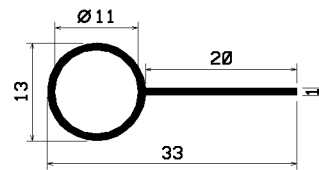

FN2128  
EP/s/ 7331

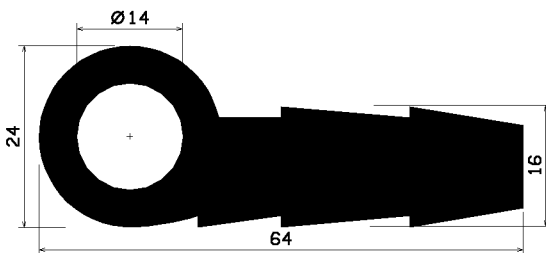

FN2159  
NBR/s/ 7594

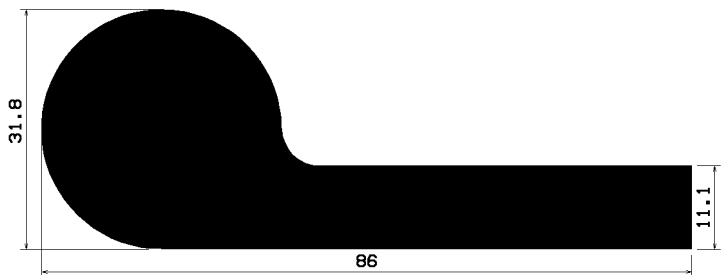

FN2165  
EP/s/ 7607



# Vollgummi bzw. Weich-PVC

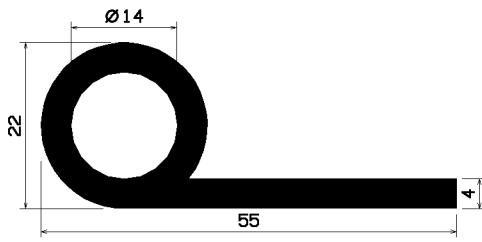

FN2181  
EP/s/ 7629

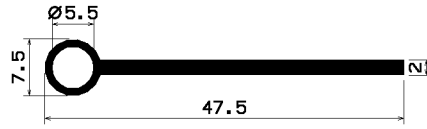

FN2182  
EP/s/ 7628

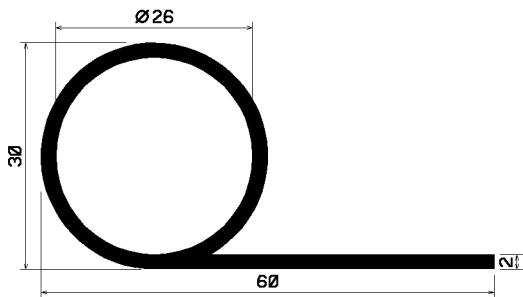

FN2186  
EP/s/ 7650

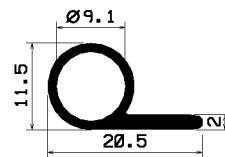

FN2203  
Si/br/ 7684

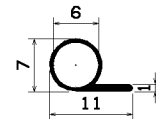

FN2206  
Si/br/ 7693

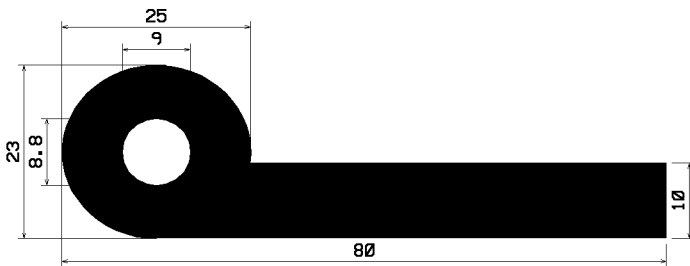

FN2209  
EP/s/ 7695

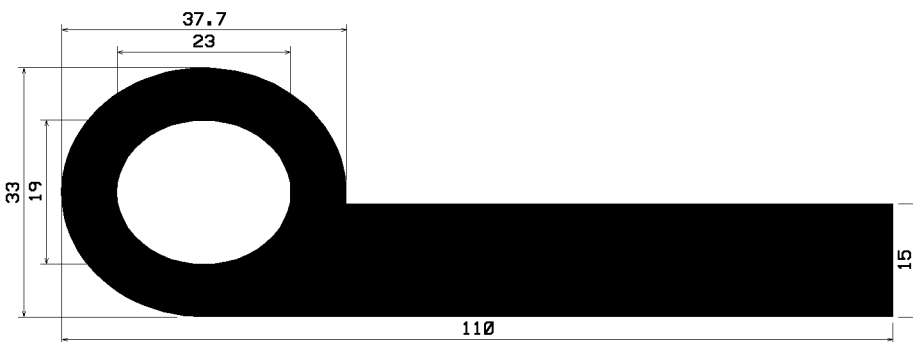

FN2229  
EP/s/ 7821

# Vollgummi bzw. Weich-PVC

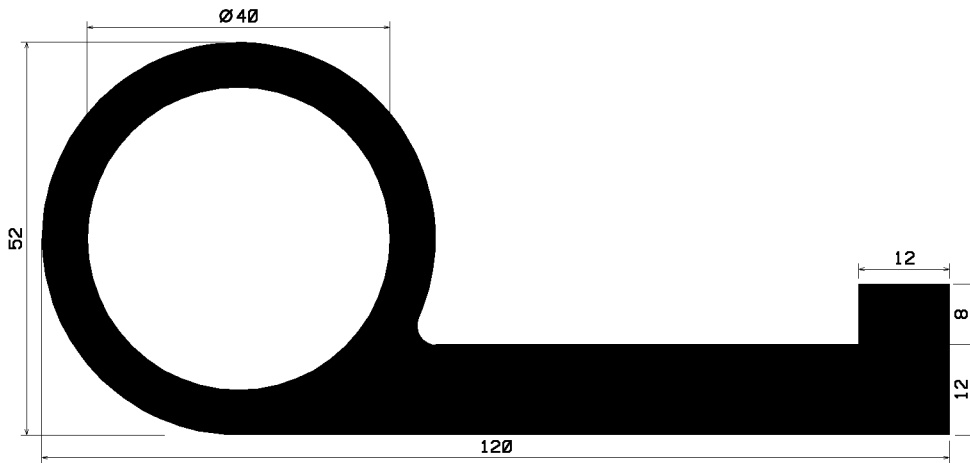

FN2251  
EP/s/7862

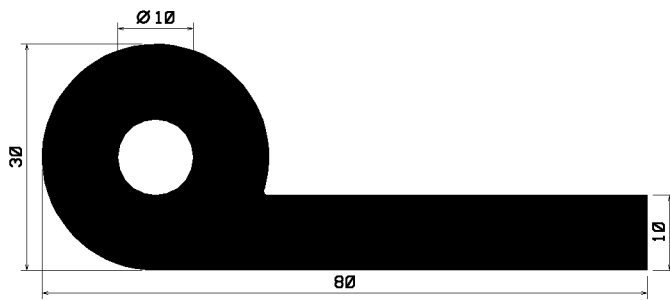

FN2253  
FPM/s/7863

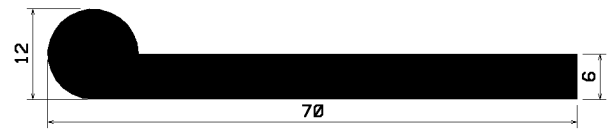

FN2255  
EP/s/7873

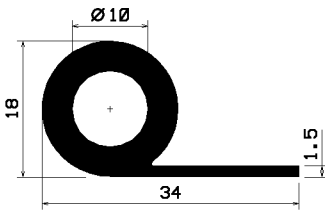

FN2256  
Si/w/7892

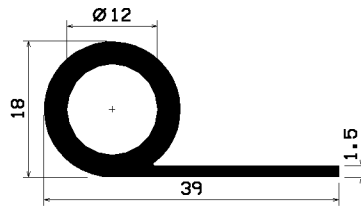

FN2268  
Si/w/7952

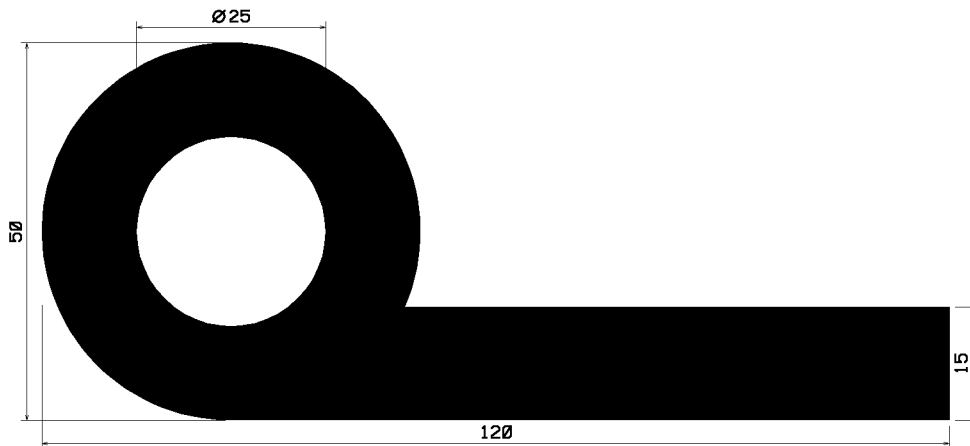

FN2295  
NR/SBR/s/7996

# Vollgummi bzw. Weich-PVC



FN2296

NR/SBR/s/ 7995

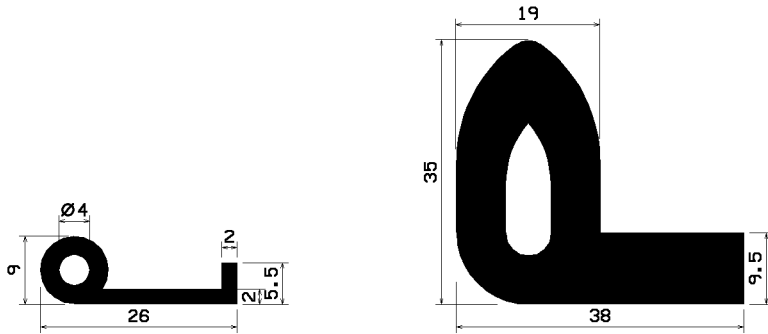

FN2307

FPM/s/ 8063

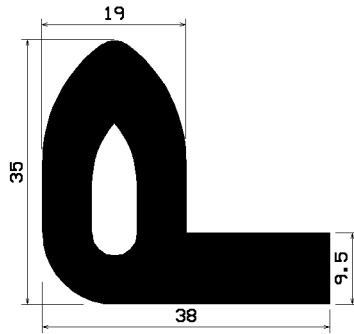

FN2321

EP/s/ 8076

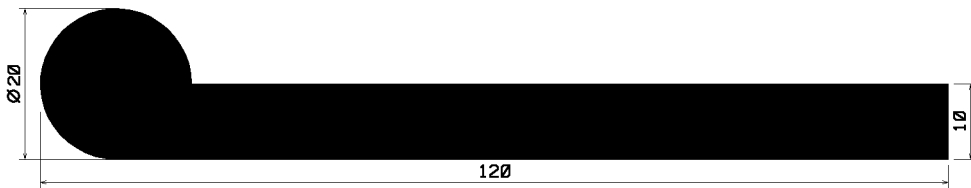

FN2334

EP/s/ 8113

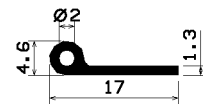

FN2340

EP/s/ 8132

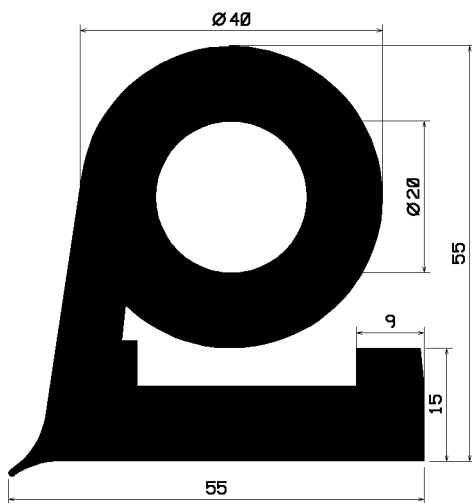

FN2346

EP/s/ 8133

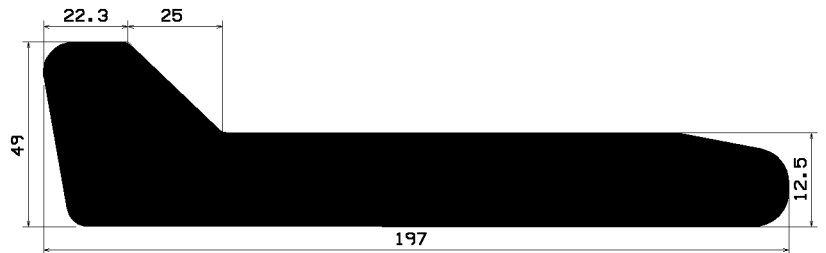

M. 1:2

FN2364

EP/s/ 8190

# Vollgummi bzw. Weich-PVC

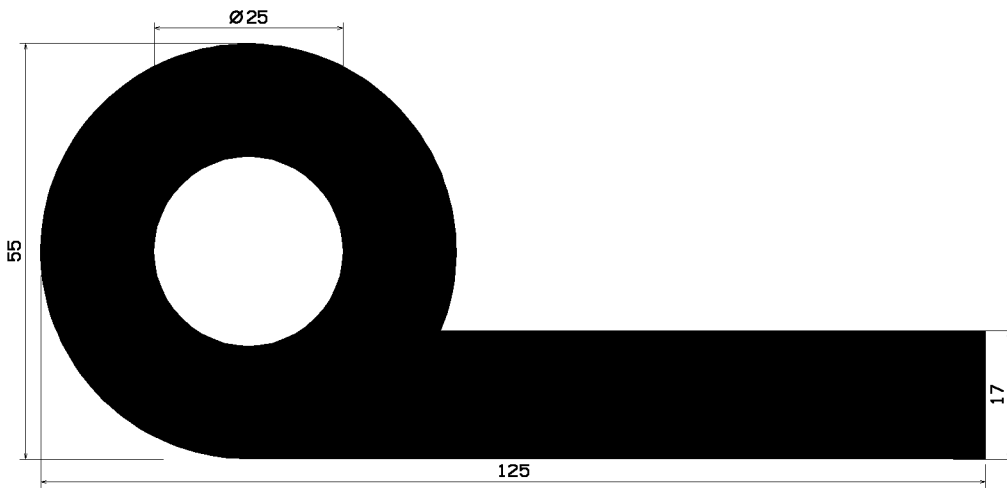

FN2368  
EP/s/ 8196

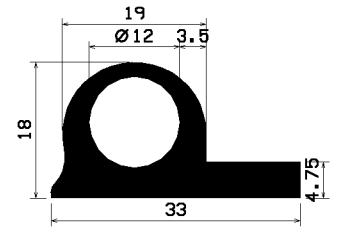

FN2377  
EP/s/ 8213

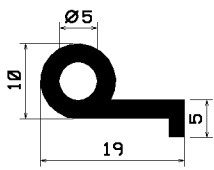

FN2395  
Si/rb/ 8266

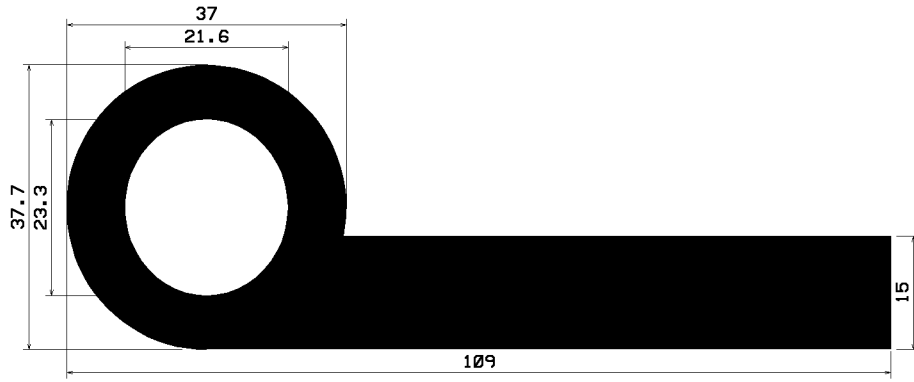

FN2399  
EP/s/ 8258

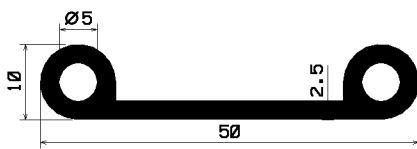

FN2401  
EP/s/ 8264

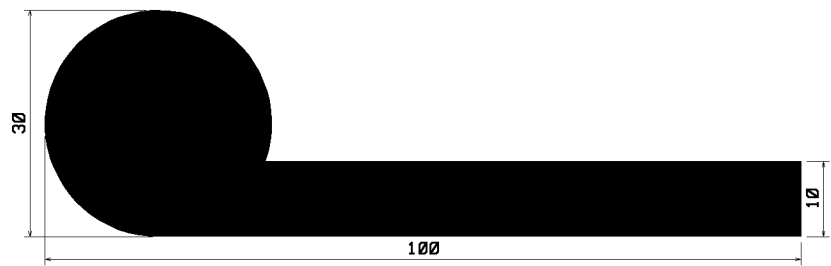

FN2439  
EP/s/ 7405

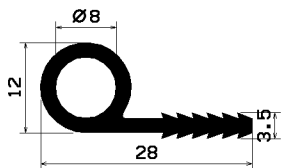

FN2454  
Si/rb/ 7420

# Moosgummi

## Zeichenerklärung

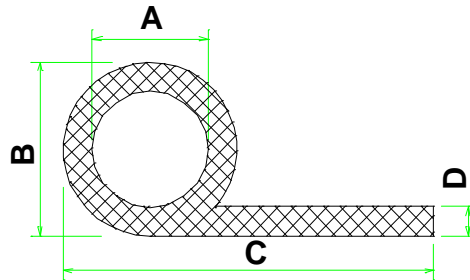

**25999**

bedeutet

*Profil-Nr.*

**EP / s / 9999 / (9998)**

bedeutet

*Qualität / Farbe / Artikel-Nr. / (Artikel-Nr. mit sk)*

sk = selbstklebend

### Qualität

CR	Neoprene
EP	EPDM
NBR	Perbunan
NK	Naturkautschuk
Si	Silikon
SPS	Silikonschaum
FPM	VITON®
PVC	Weich-PVC
...-FR	selbst verlöschend

### Farbe

s	schwarz
g	grau
w	weiß
az	anthrazit
bg	beige
br	braun
hg	hellgrau
rb	rotbraun
t	transparent
x	Farbe wählbar

â = Eingetragenes Warenzeichen der Firma DuPont

# Moosgummi

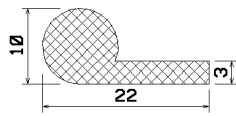

25003  
EP/s/ 0261

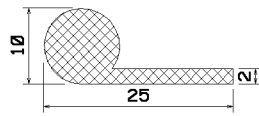

25004  
EP/s/ 0262/(4464)

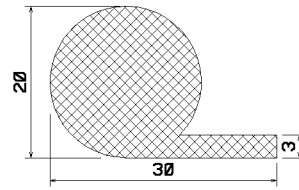

25027  
NBR/s/ 0287

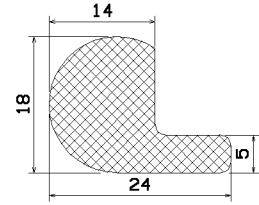

25034  
EP/s/ 0293

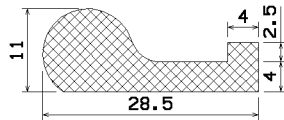

25056  
EP/s/ 0314

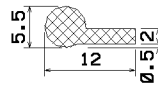

25069  
EP/s/ 0325

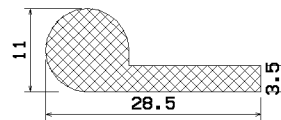

25095  
EP/s/ 0349

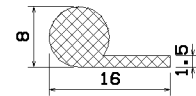

25124  
EP/s/ 0377

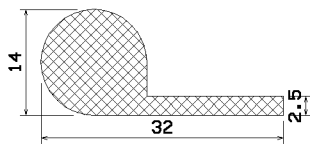

25208  
EP/s/ 2168  
EP/g/ 2754

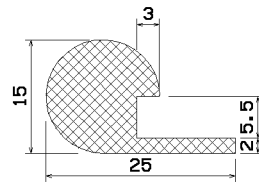

25210  
EP/g/ 2208

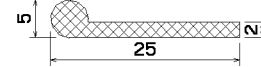

25224  
EP/s/ 2863/(4348)

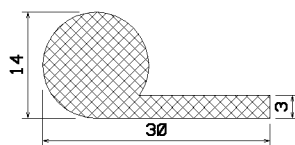

25241  
EP/s/ 3012/(3766)  
EP/g/ 3006

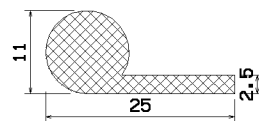

25242  
EP/g/ 3002

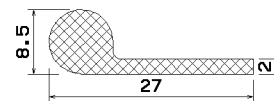

25270  
EP/s/ 3173  
EP/g/ 3184

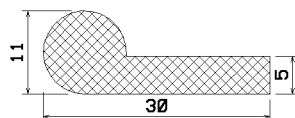

25274  
EP/g/ 3231

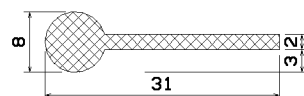

25329  
EP/g/ 3652

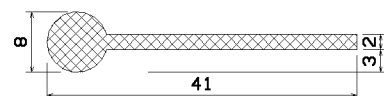

25352  
EP/g/ 2998

# Moosgummi

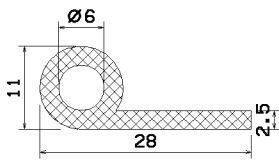

25362  
CR/s/ 3877

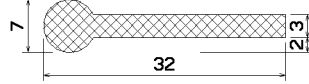

25398  
EP/s/ 4161

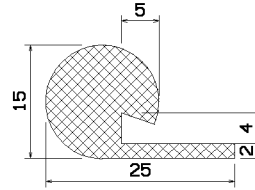

25438  
EP/g/ 1309

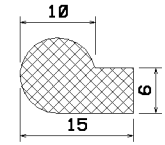

25450  
NBR/g/ 1985

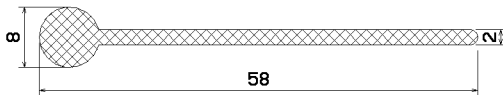

25466  
EP/s/ 4211

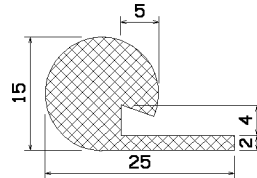

25472  
EP/g/4267

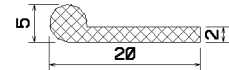

25483  
EP/s/ 4378/(4379)

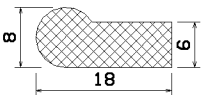

25544  
EP/g/5048  
CR/s/5049

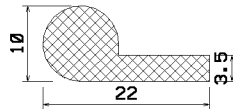

25545  
EP/s/5050

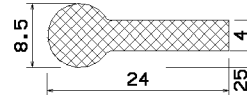

25546  
EP/s/ 5051

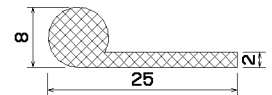

25547  
NK/g/ 5052

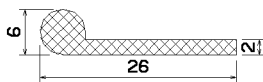

25548  
NK/g/ 5053

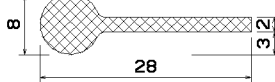

25549  
EP/s/ 5054

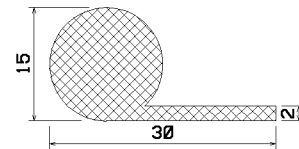

25550  
NK/g/5055

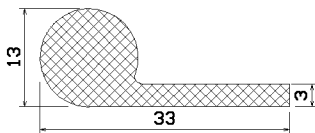

25551  
CR/s/5056

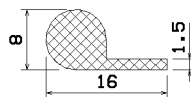

25645  
EP/g/ 4674

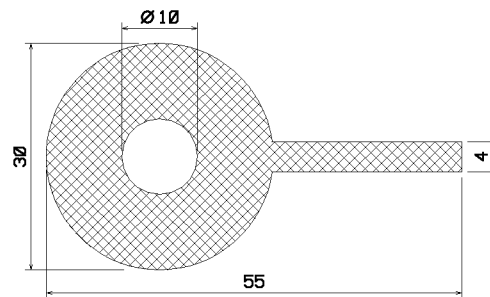

25793  
NBR/hg/ 8069