

---

---

# **gummi-plast**

Schild GmbH & Co.KG

Gernsheim

---

---



**Profile aus Gummi, Moosgummi,  
Silikon, Schaum silikon**

D-64579 Gernsheim

Otto-Hahn-Straße 12

Telefon 0 62 58 / 932250

Telefax 0 62 58 / 4997

e-mail: [schild@gummi-plast.de](mailto:schild@gummi-plast.de)

internet: <http://www.gummi-plast.de>

## Silikon-Profile

### Liste Nr. 318

letzte Änderung: 27.09.2008

Si

# Zeichenerklärung

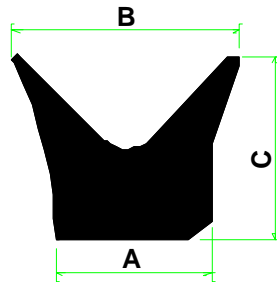

**Si9999**

bedeutet

*Profil-Nr.*

**Si / s / 9999 / (9998)**

bedeutet

*Qualität / Farbe / Artikel-Nr. / (Artikel-Nr. mit es.sk)*

es.sk = einseitig selbstklebend

## Qualität

Si      Silikon

## Farbe

s	schwarz
g	grau
t	transparent
w	weiß
az	anthrazit
bl	blau
bg	beige
br	braun
hg	hellgrau
rb	rotbraun
r	rot
x	Farbe wählbar

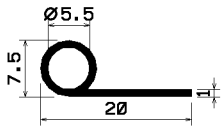

FN104

Si/s/ 3160

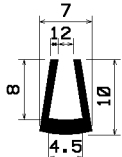

TU1-113

Si/x/ 1801

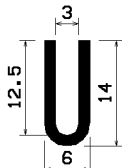

TU1-186

Si/t/ 5861

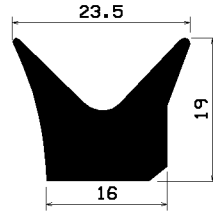

S218

Si/r/ 3256

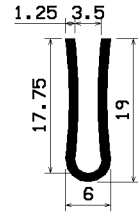

TU1-228

Si/t/ 5862

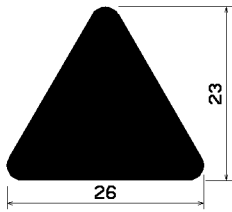

S248

Si/t/ 1851

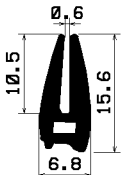

TU1-317

Si/x/ 1805

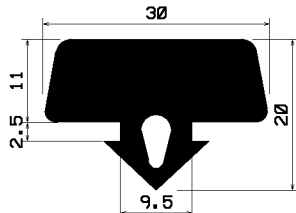

AU319

Si/t/ 7671

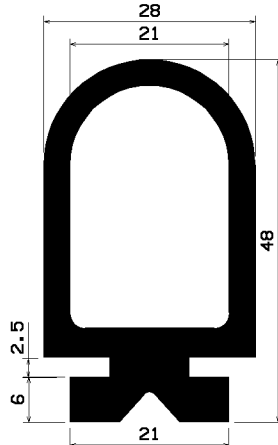

RT355

Si/r/ 1715

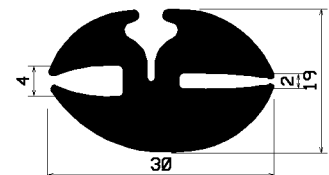

KL383

Si/s/ 1666

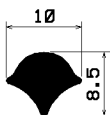

FR384

Si/s/ 1652

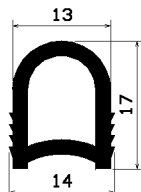

S404

Si/w/ 2910

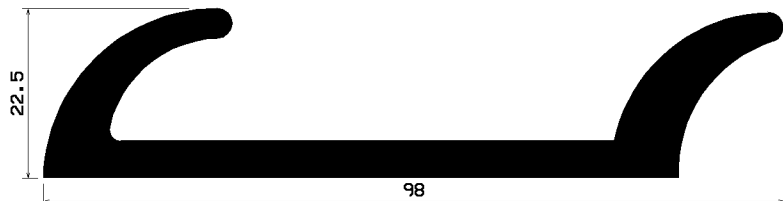

S432

Si/r/ 2894

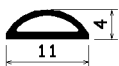

S437

Si/t/ 2892

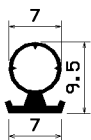

S442

Si/s/ 2896



S454

Si/rb/ 2897

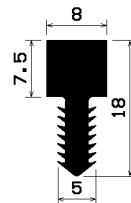

S477

Si/t/ 2889



S478

Si/g/ 2903

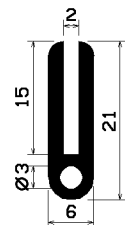

TU1-529

Si/s/ 4120

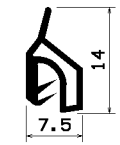

Z1-575  
Si/r/ 1737

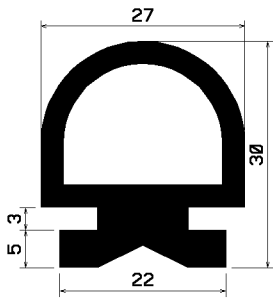

RT591  
Si/r/ 1730



S600  
Si/s/ 1854

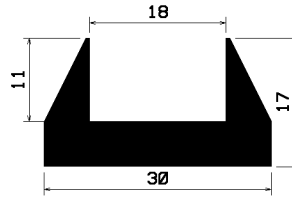

TU1-648  
Si/r/ 1810

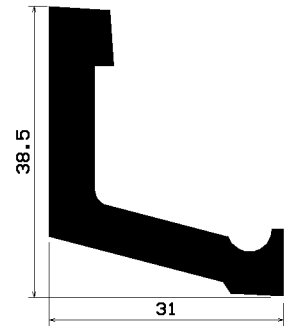

S656  
Si/rb/ 2573

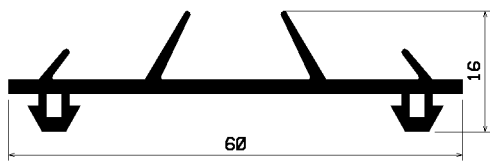

F704  
Si/s/ 1522

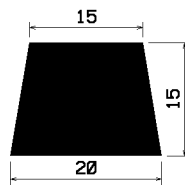

TR728  
Si/r/ 1952

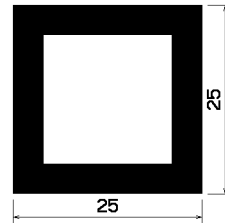

S729  
Si/r/ 2110

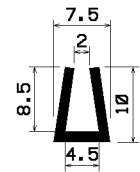

TU1-755  
Si/r/ 2213

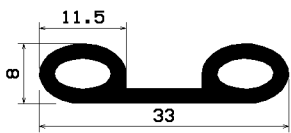

S762  
Si/r/ 2258

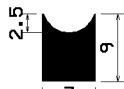

S763  
Si/r/ 2262

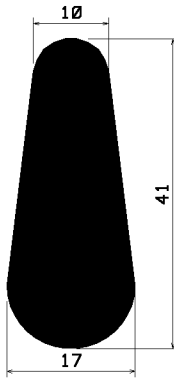

S768  
Si/r/ 2302

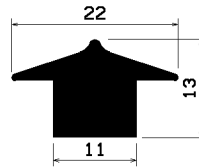

S786  
Si/r/ 2557

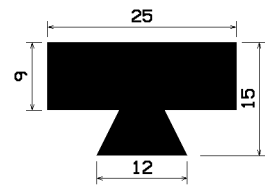

S793  
Si/s/ 5857

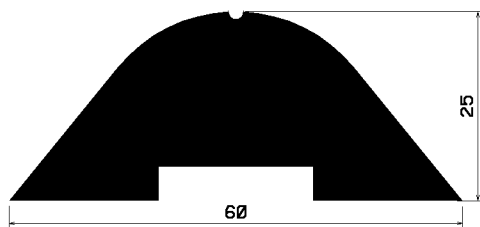

S820  
Si/rb/ 2678

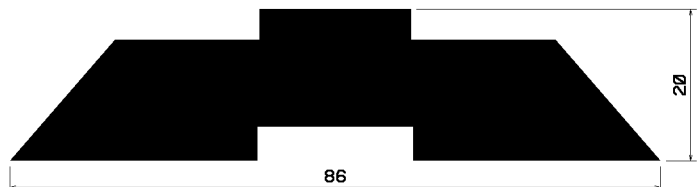

S821  
Si/rb/ 2679

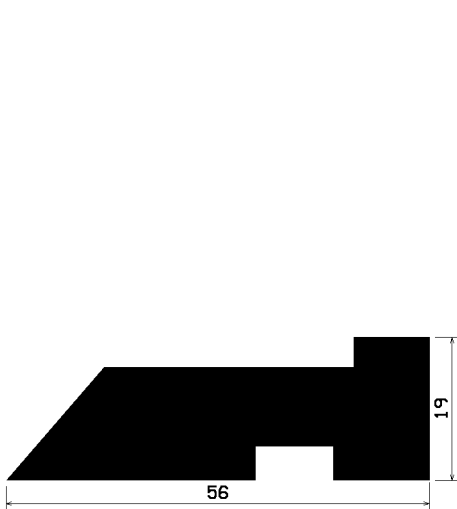

S822  
Si/rb/ 2680

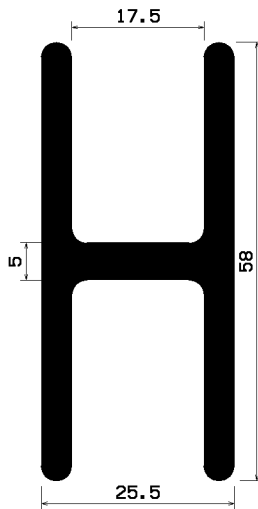

H836  
Si/t/ 7410

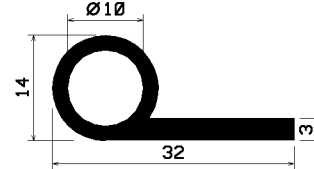

FN848  
Si/g/ 2934

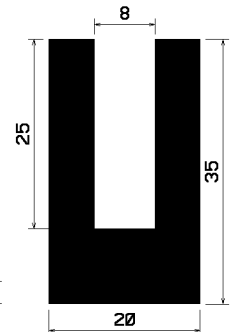

TU1-851  
Si/rb/ 2943

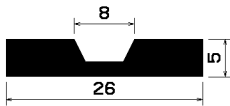

S881  
Si/t/ 3027

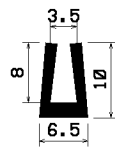

TU1-882  
Si/t/ 3033

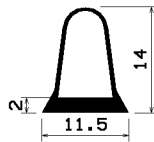

RT887  
Si/w/ 3039

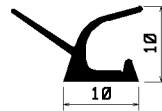

AN897  
Si/t/ 3067

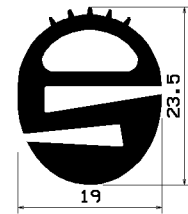

S901  
Si/s/ 3077

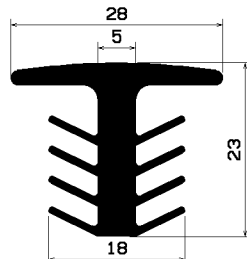

FA904/2  
Si/t/ 3086



S940  
Si/s/ 3196



S953  
Si/s/ 3235



S955  
Si/rb/ 3247

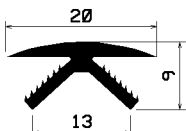

S956  
Si/t/ 3250

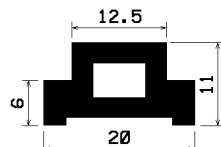

S965  
Si/s/ 3261



S982  
Si/g/ 3312

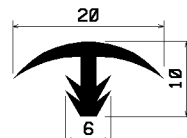

FA998  
Si/t/ 3338  
Si/w/ 3404  
Si/g/ 3640  
Si/s/ 3802

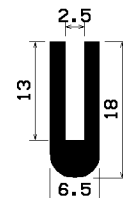

TU1-1011  
Si/t/ 3368  
Si/s/ 4299

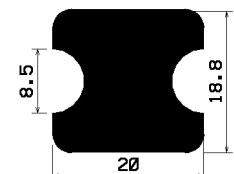

S1012  
Si/w/ 3369

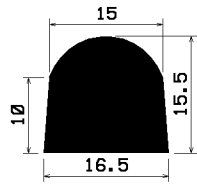

HR1013  
Si/t/ 3371

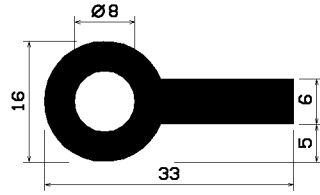

FN1014  
Si/t/ 3381

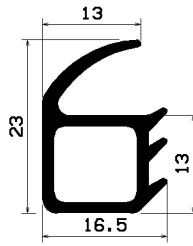

Z1-1015  
Si/s/ 5815

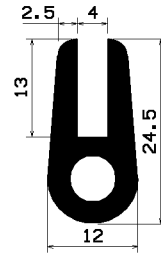

TU1-1022  
Si/t/ 3398

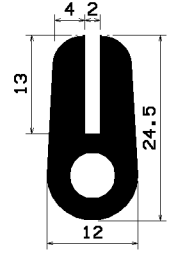

TU1-1044  
Si/t/ 3425

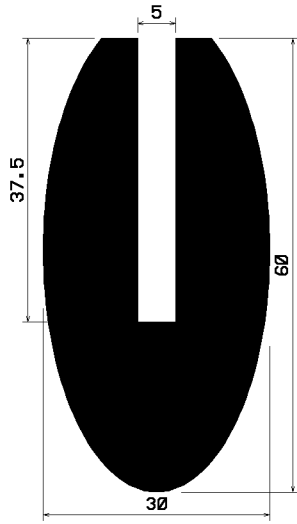

TU1-1083  
Si/t/ 3558

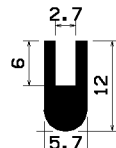

TU1-1050  
Si/t/ 3447

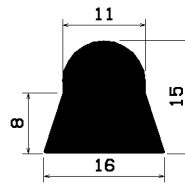

S1059  
Si/s/ 3525



Wi1072  
Si/g/ 3497

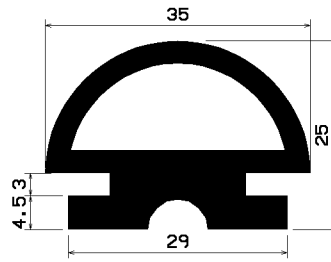

RT1088  
Si/g/ 3591  
Si/s/ 6472

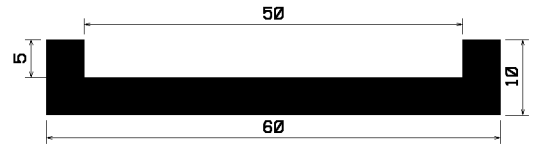

TU1-1101  
Si/w/ 3633

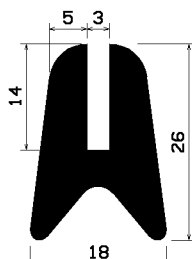

TU1-1109  
Si/s/ 3658

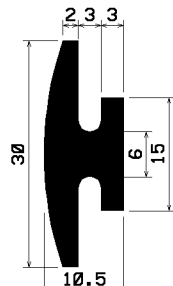

H1120  
Si/w/ 5380

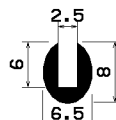

TU1-1132  
Si/t/ 3737

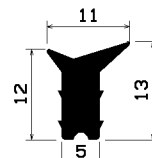

S1138  
Si/s/ 3758

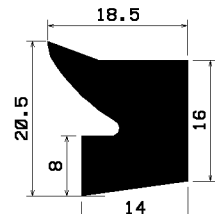

S1142  
Si/rb/ 3772

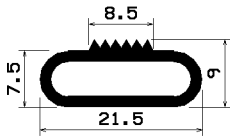

S1160  
Si/rb/3829

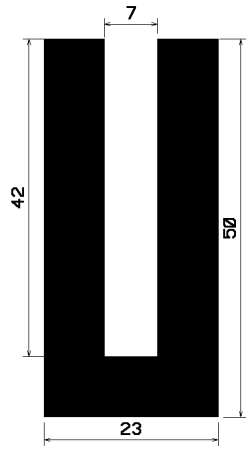

TU1-1164  
Si/s/3840

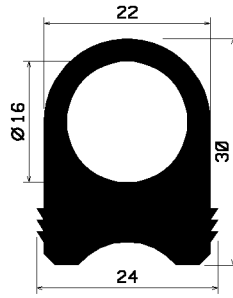

S1180  
Si/g/3904

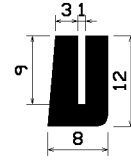

TU1-1182  
Si/t/3915

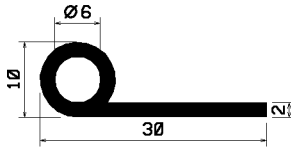

FN1205  
Si/t/3955

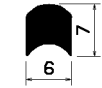

HR1208  
Si/r/1238

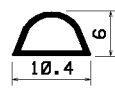

S1210  
Si/s/3970

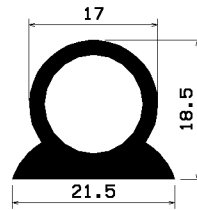

RT1214  
Si/t/3997

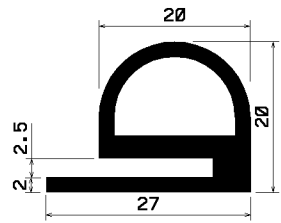

RT1227  
Si/s/4023

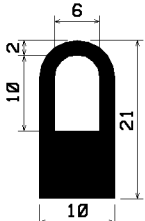

HR1233  
Si/rb/4038

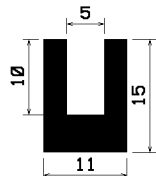

TU1-1263  
Si/t/4097

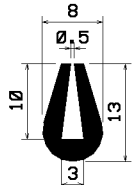

TU1-1264  
Si/t/4108

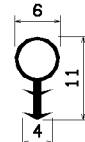

SC1282  
Si/bg/4157

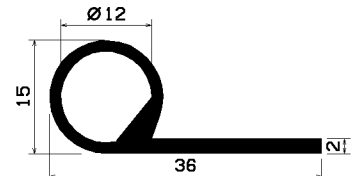

FN1285  
Si/rb/4166

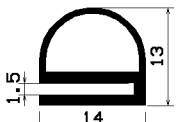

RT1297  
Si/t/4185

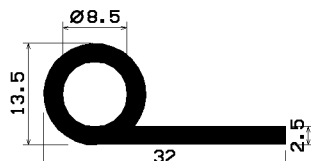

FN1301  
Si/rb/4184

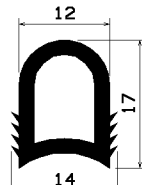

HR1308  
Si/o/2313



T1311  
Si/t/0306

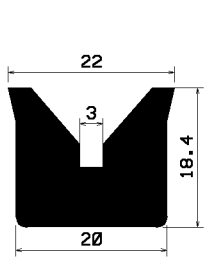

S1315  
Si/g/1025

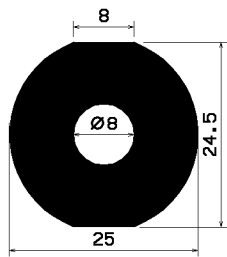

S1322  
Si/bg/1148

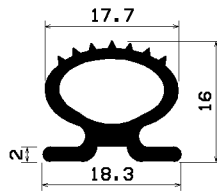

RT1330  
Si/rb/ 1123  
Si/s/ 5238

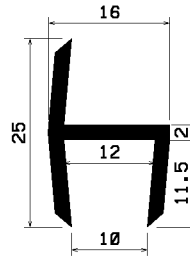

H1333  
Si/l/ 7937

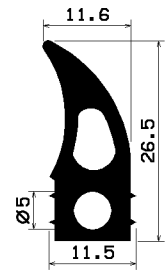

S1334  
Si/bg/1166

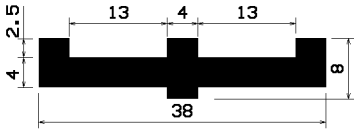

S1339  
Si/rb/ 1177

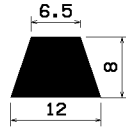

TR1361  
Si/t/ 1299

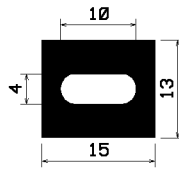

S1385  
Si/l/ 1879

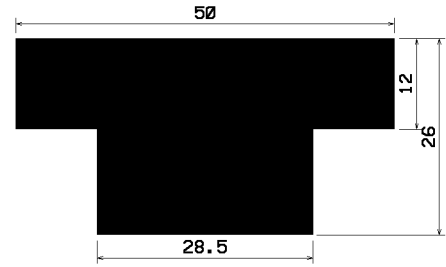

T1389  
Si/t/ 1874

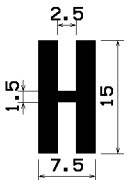

H1395  
Si/l/ 2141

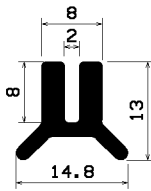

TU1-1396  
Si/l/ 2199

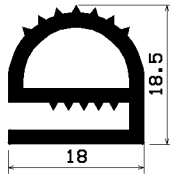

RT1399  
Si/g/ 3156

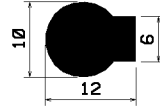

FN1400  
Si/l/ 2594

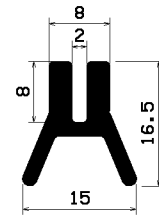

TU1-1408  
Si/t/ 3794

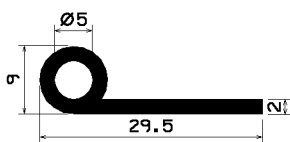

FN1409  
Si/s/ 2526

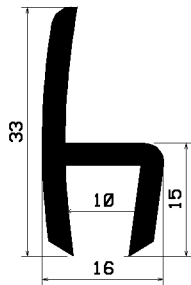

H1412  
Si/l/ 4217  
Si/s/ 4631

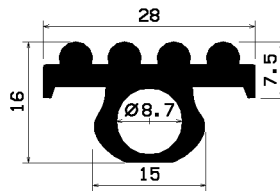

S1440  
Si/t/ 4393

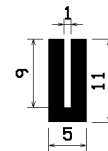

TU1-1446  
Si/bg/4450



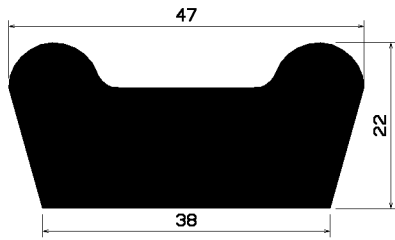

S1448  
Si/s/ 4436

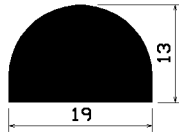

HR1451  
Si/t/ 4466



HR1454  
Si/bg/4482

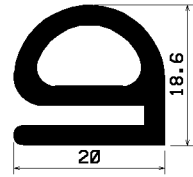

RT1461  
Si/t/ 4539

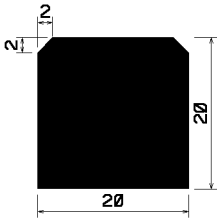

S1478  
Si/t/ 4637

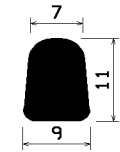

HR1491  
Si/t/ 4391

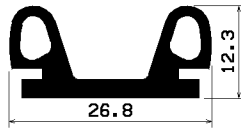

S1499  
Si/s/ 4741

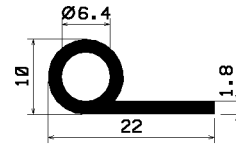

FN1507  
Si/g/4698

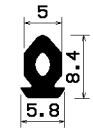

S1518  
Si/rb/ 4727



S1522  
Si/g/4748

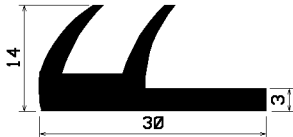

S1529  
Si/rb/ 4747

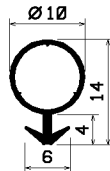

SC1542  
Si/s/ 4777

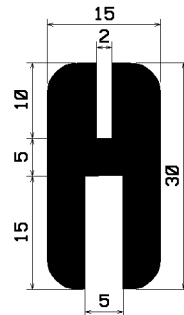

H1556  
Si/s/ 4859

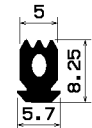

S1561  
Si/rb/ 5299

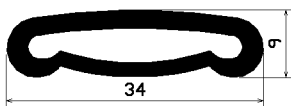

S1562  
Si/rb/4994

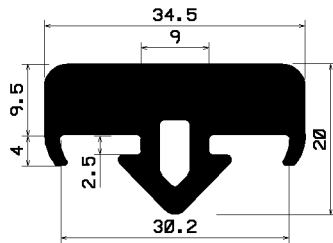

AU1583  
Si/rb/1052

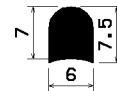

HR1593  
Si/rb/ 5234

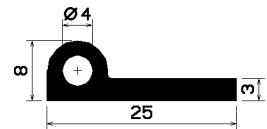

FN1596  
Si/rb/ 5294

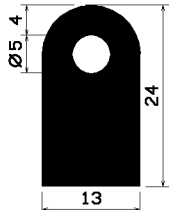

HR1597  
Si/t/ 5227

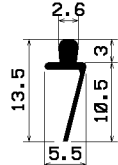

AN1602  
Si/s/ 5252

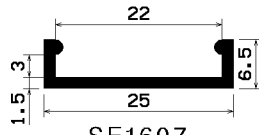

SE1607  
Si/g/ 5306

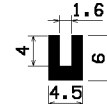

TU1-1611  
Si/rb/ 5913

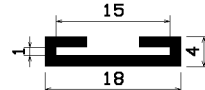

SE1612  
Si/t/ 5941

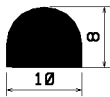

HR1613  
Si/t/ 5321

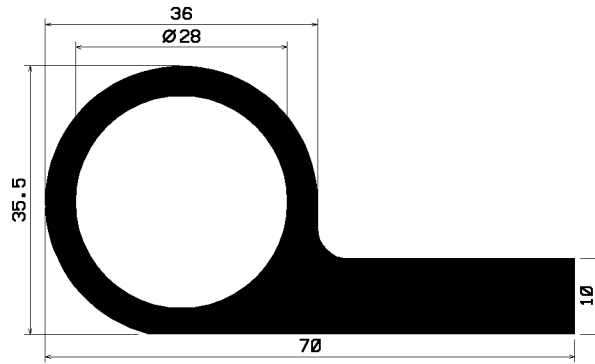

FN1615  
Si/t/ 5328

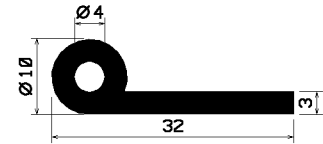

FN1624  
Si/s/ 5364

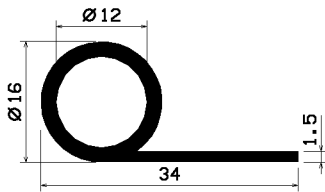

FN1625  
Si/rb/ 5370

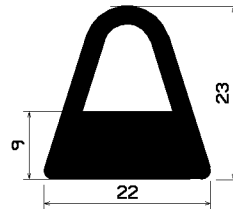

HR1626  
Si/t/ 5371

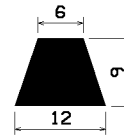

TR1632  
Si/t/ 5400

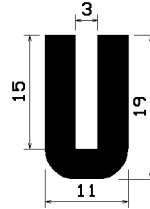

TU1-1633  
Si/t/ 5386

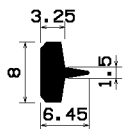

S1640  
Si/bl/ 5394/(5395)

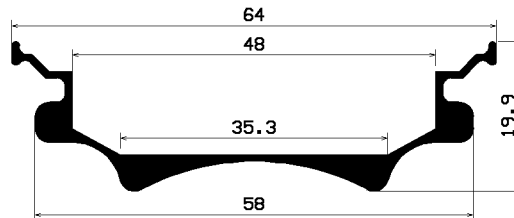

S1643  
Si/t/ 5457

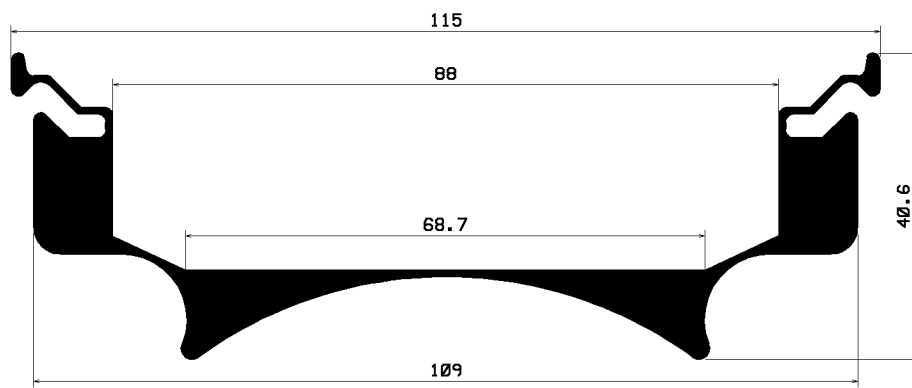

S1644  
Si/t/ 5458

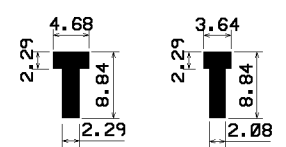

T1647 Si/s/ 5471  
T1648 Si/s/ 5472

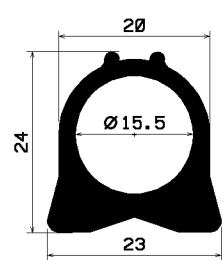

RT1664  
Si/rb/ 5636

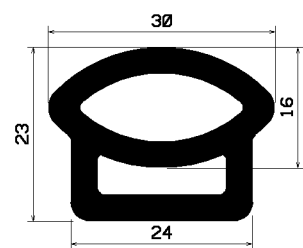

S1665  
Si/t/ 5652

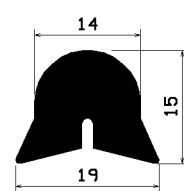

S1666  
Si/t/ 5493

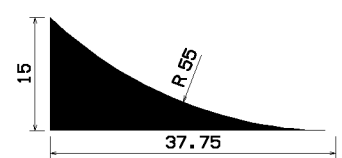

S1676  
Si/rb/ 5711



S1677  
Si/rb/ 5714

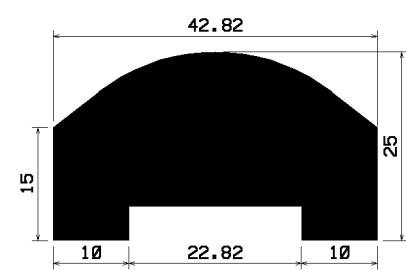

S1678  
Si/rb/ 5712

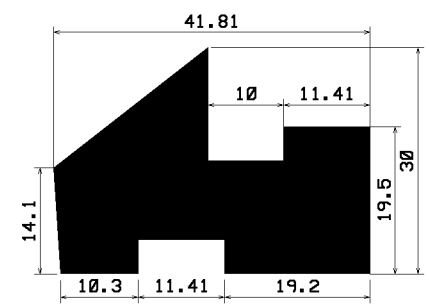

S1679  
Si/rb/ 5713

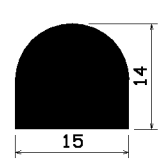

HR1686  
Si/t/ 5727

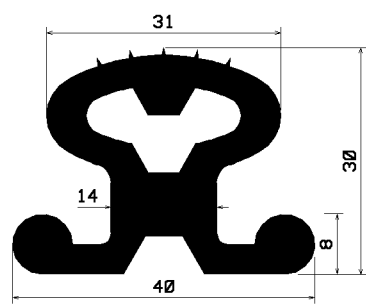

S1698  
Si/rb/ 5781

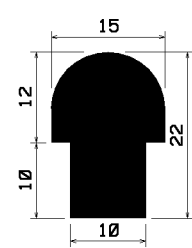

FA1701  
Si/t/ 5776

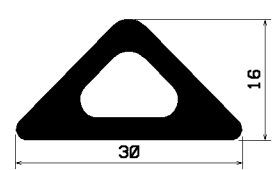

S1703  
Si/rb/ 5823

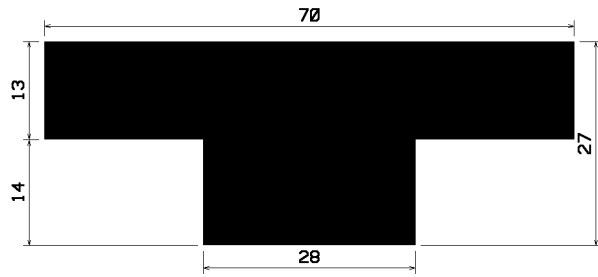

T1707  
Si/t/ 5818

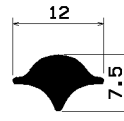

FR1708  
Si/r/ 5881

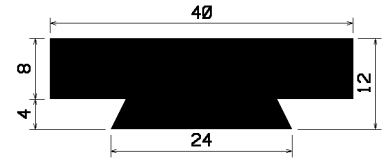

S1712  
Si/s/ 5856

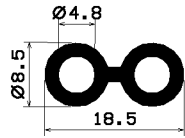

S1713  
Si/s/ 5853

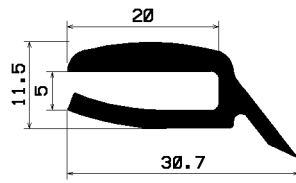

S1726  
Si/t/ 5897

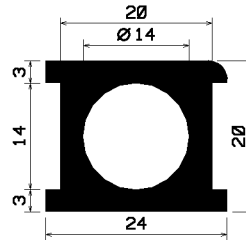

S1729  
Si/rb/ 5934

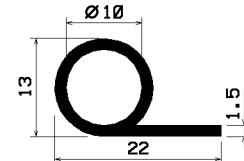

FN1730  
Si/rb/ 5935

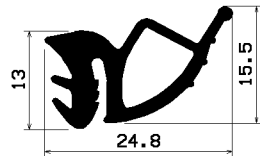

S1732  
Si/rb/ 5928

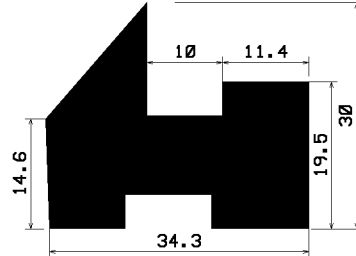

S1736  
Si/g/ 5953

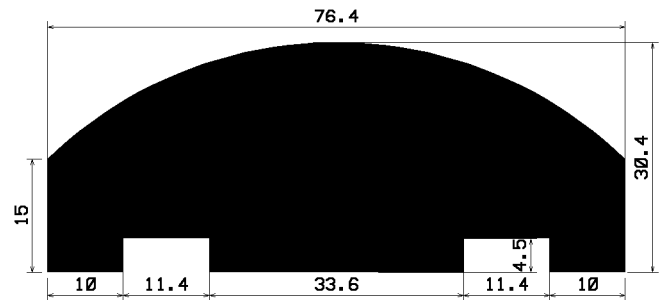

S1737  
Si/rb/ 5954

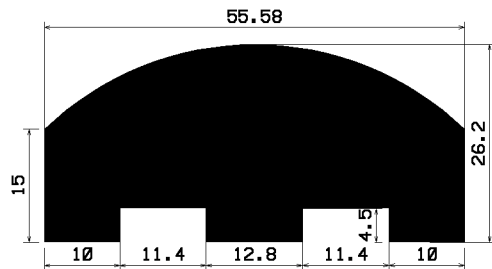

S1738  
Si/rb/ 5955

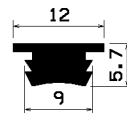

FA1742  
Si/t/ 5967

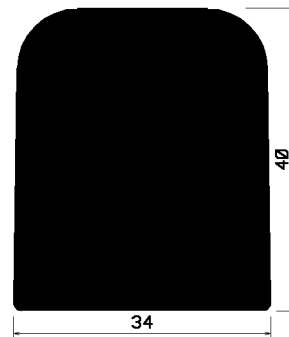

HR1745  
Si/rb/ 5980

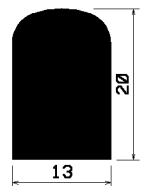

HR1752  
Si/rb/ 6003

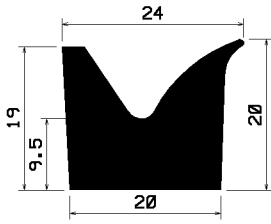

S1760  
Si/t/ 6015

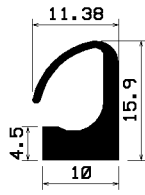

S1762  
Si/s/ 6013



S1765  
Si/rb/ 6025

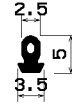

S1766  
Si/rb/ 6026

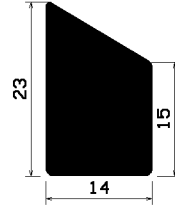

TR1774  
Si/t/ 6049

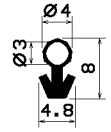

SC1776  
Si/w/6042

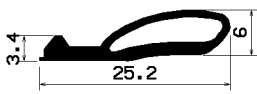

S1784  
Si/rb/ 6071

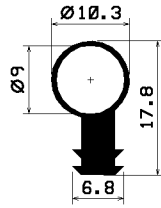

S1787  
Si/w/ 6084

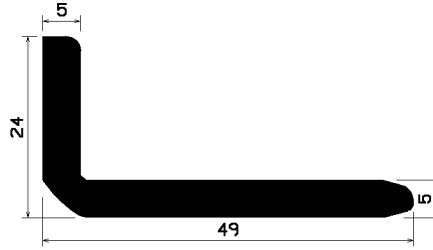

Wi1791  
Si/t/ 6088

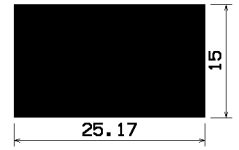

S1794  
Si/rb/ 6087

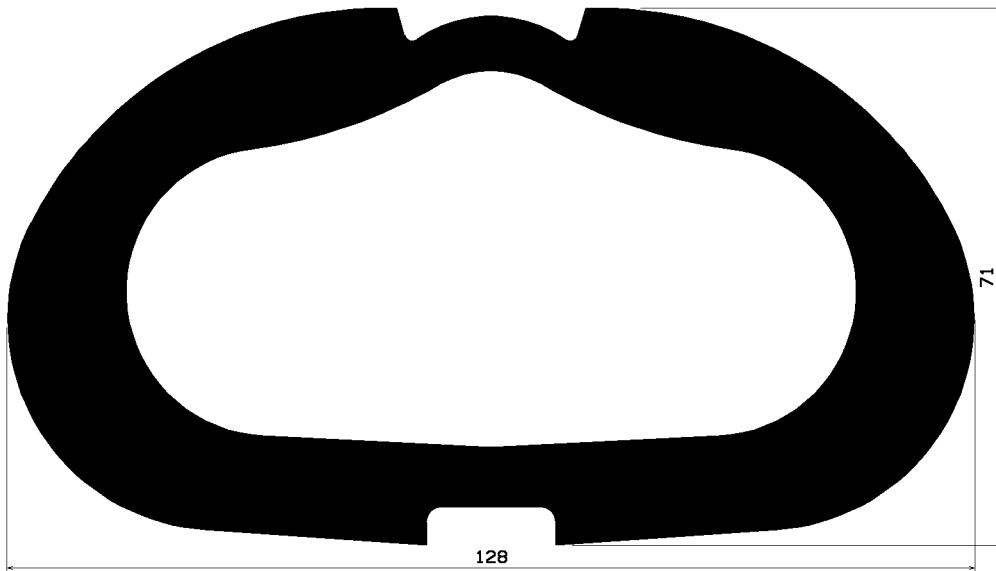

SC1804  
Si/t/ 6109

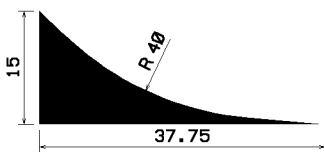

S1805  
Si/rb/ 6130

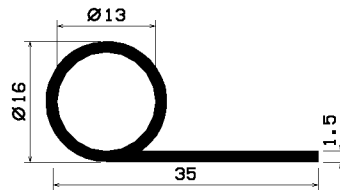

FN1812  
Si/t/ 6152

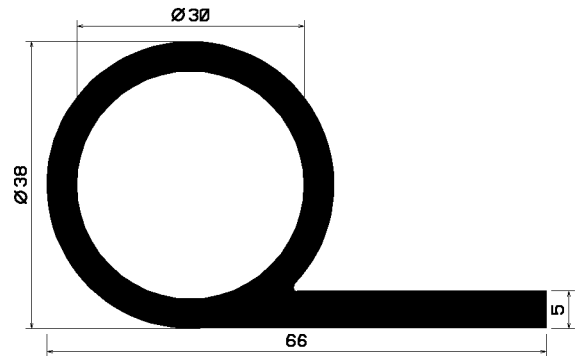

FN1817  
Si/g/ 6143

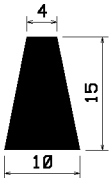

TR1819  
Si/s/ 6154

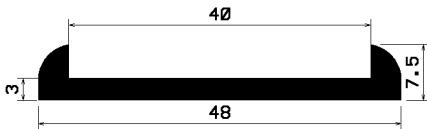

TU1-1821  
Si/t/ 6166

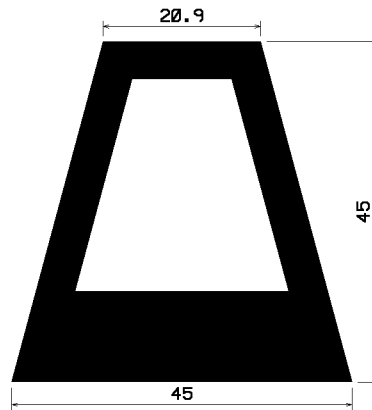

TR1833  
Si/t/ 6205

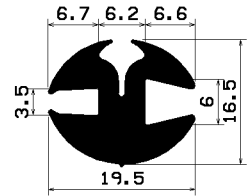

KL1834  
Si/s/ 6208

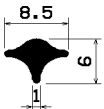

FR1835  
Si/s/ 6209

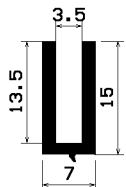

TU1-1838  
Si/az/ 6207

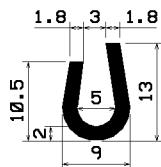

TU1-1848  
Si/t/ 6456

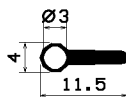

FN1856  
Si/s/ 6429

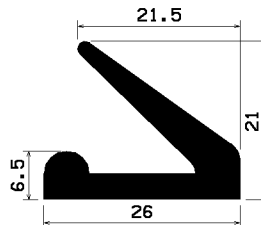

AN1867  
Si/s/ 6469

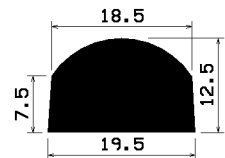

HR1870  
Si/t/ 6524

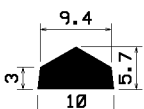

S1878  
Si/rb/ 2133

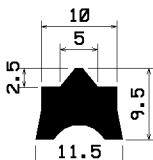

S1879  
Si/s/ 6562

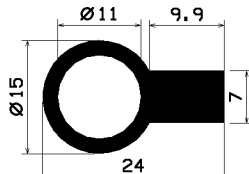

FN1880  
Si/rb/ 6563

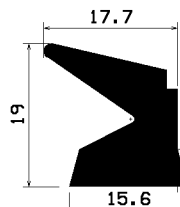

Z1-1889  
Si/t/ 6575

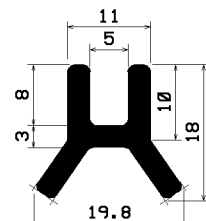

TU1-1890  
Si/s/ 6611

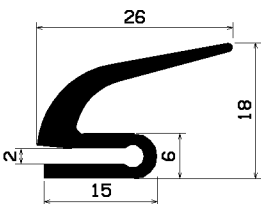

S1894  
Si/t/ 6589

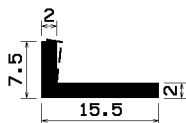

W1895  
Si/t/ 6590

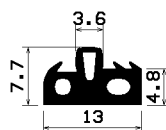

S1896  
Si/s/ 6587

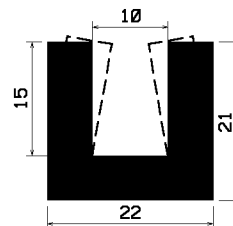

TU1-1898  
Si/t/ 6598

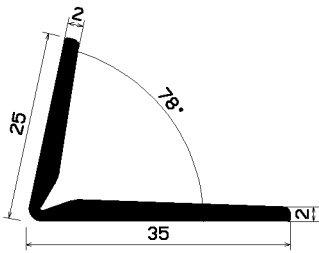

Wi1901  
Si/s/ 6622

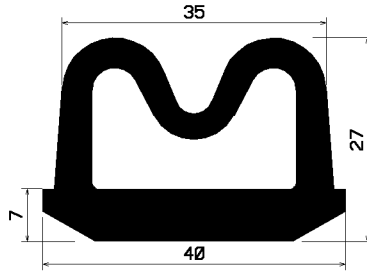

S1911  
Si/g/ 6788

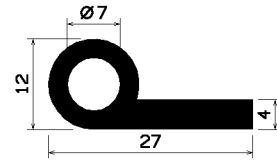

FN1914  
Si/t/ 6798

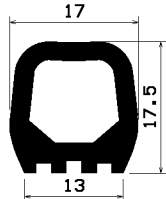

S1931  
Si/rb/ 6810

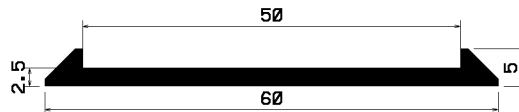

F1937  
Si/t/ 6671

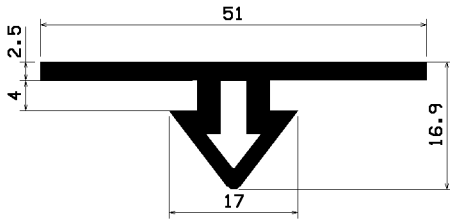

AU1938  
Si/t/ 6672

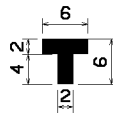

T1940  
Si/t/ 6838

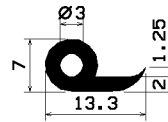

FN1967  
Si/t/ 6866

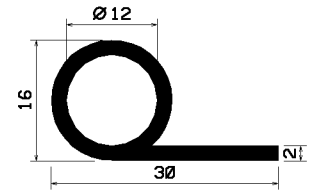

FN1976  
Si/t/ 6917

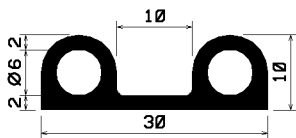

S1980  
Si/w/ 6925

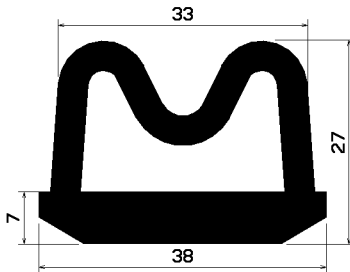

S1983  
Si/g/ 6943

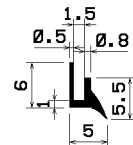

TU1-1998  
Si/g/ 6999



S2002  
Si/s/ 6971

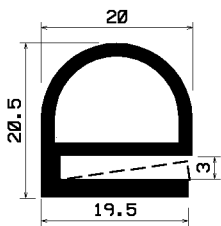

S2003  
Si/rb/ 6986

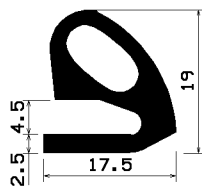

S2011  
Si/t/ 7023

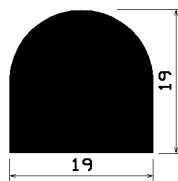

HR2014  
Si/w/ 7029

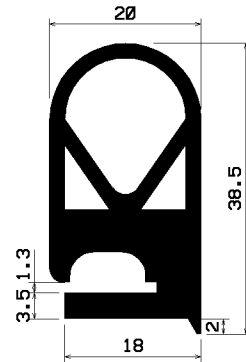

S2016  
Si/s/ 7032

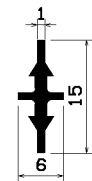

S2038  
Si/t/ 7069

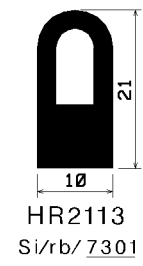
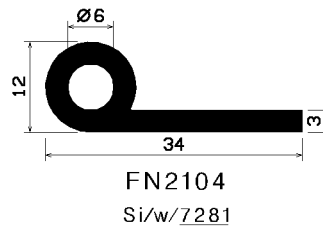
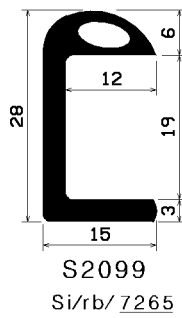
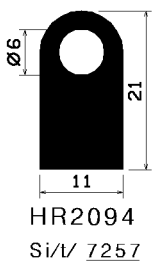
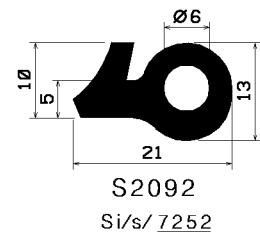
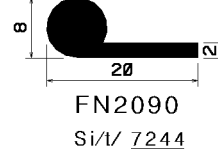
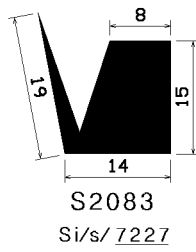
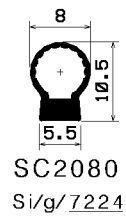
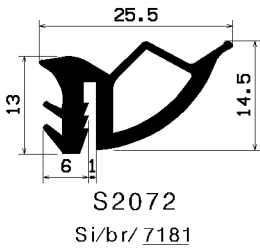
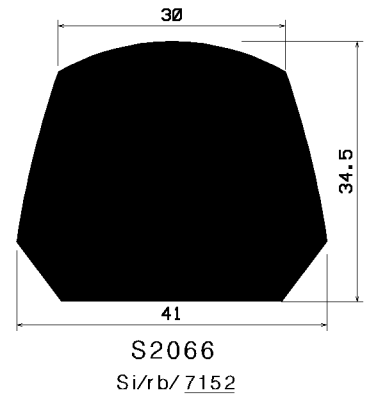
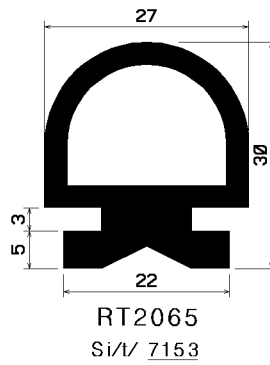
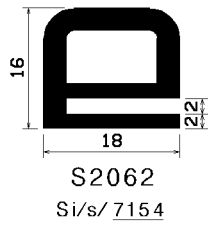
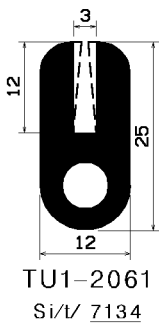
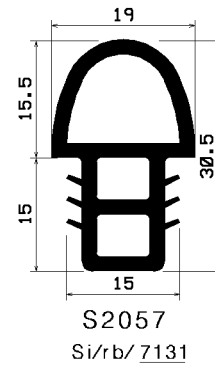
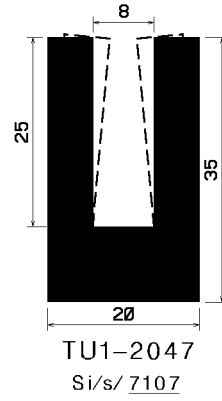
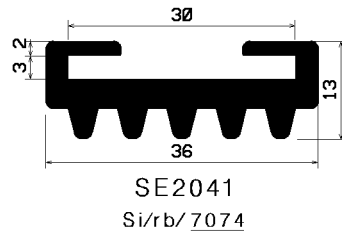
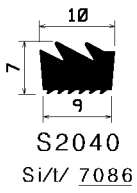



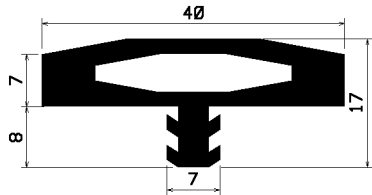

FA2114  
Si/t/ 7303

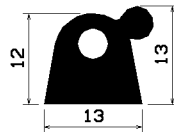

S2115  
Si/t/ 7311

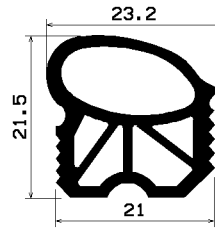

Z1-2120  
Si/g/ 7327

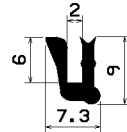

TU1-2122  
Si/t/ 7317

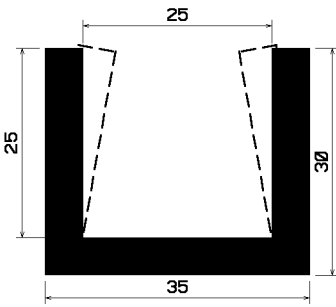

TU1-2125  
Si/t/ 7324

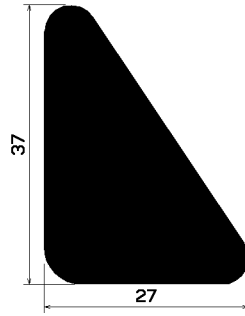

S2131  
Si/rb/ 7330

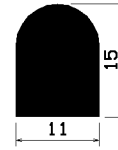

HR2136  
Si/w/ 7342

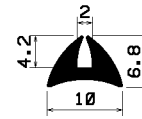

S2137  
Si/w/ 7344

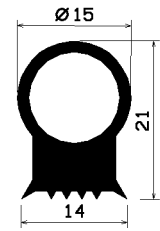

S2147  
Si/t/ 7566



S2157  
Si/rb/ 7592

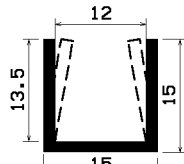

TU1-2167  
Si/t/ 7610

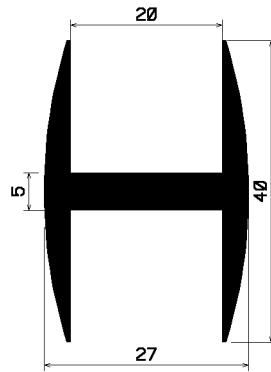

H2183  
Si/t/ 7627

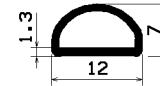

HR2185  
Si/t/ 7640

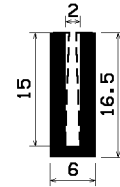

TU1-2192  
Si/w/ 7657

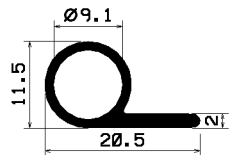

FN2203  
Si/rb/ 7684

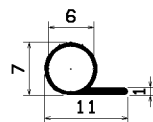

FN2206  
Si/rb/ 7693

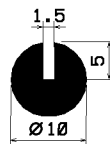

S2228  
Si/t/ 7820



S2233  
Si/rb/ 7826

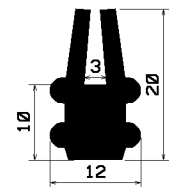

S2238  
Si/t/ 7839

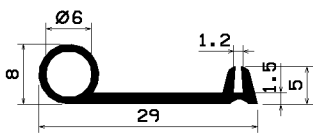

S2239  
Si/rb/ 7840

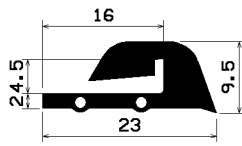

S2240  
Si/bl/ 7841

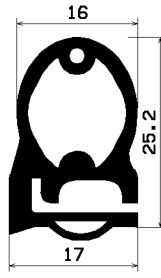

S2241  
Si/rb/ 7842

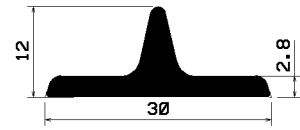

S2254  
Si/t/ 7874

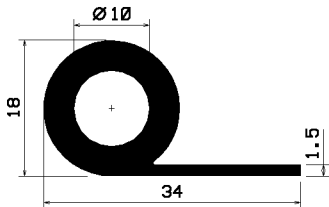

FN2256  
Si/w/ 7892

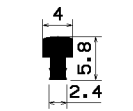

S2261  
Si/rb/ 7922

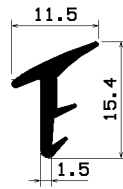

VP2263  
Si/t/ 7925

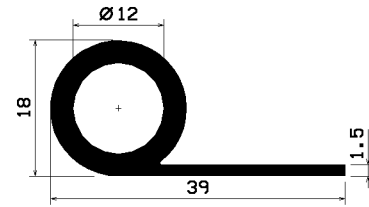

FN2268  
Si/w/ 7952

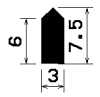

S2282  
Si/w/ 7981



TU1-2287  
Si/t/ 5862

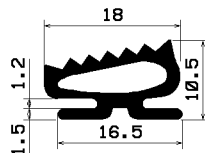

S2298  
Si/r/ 7998

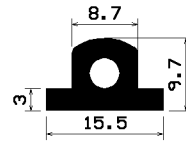

S2299  
Si/t/ 8014

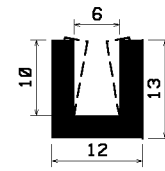

TU1-2301  
Si/t/ 8010

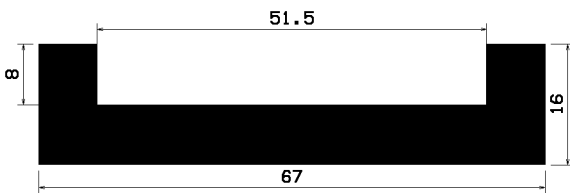

TU1-2316  
Si/t/ 8055

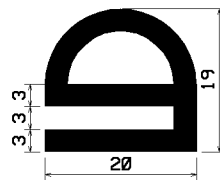

RT2318  
Si/t/ 8058

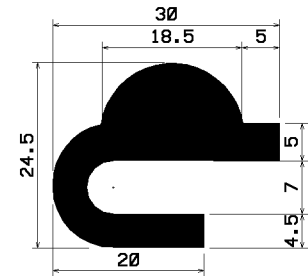

S2344  
Si/r/ xxxx



S2358  
Si/t/ 8171

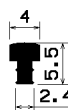

S2359  
Si/rb/ 8173

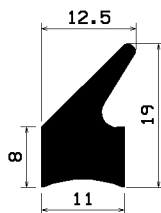

Z1-2366  
Si/r/ 8198

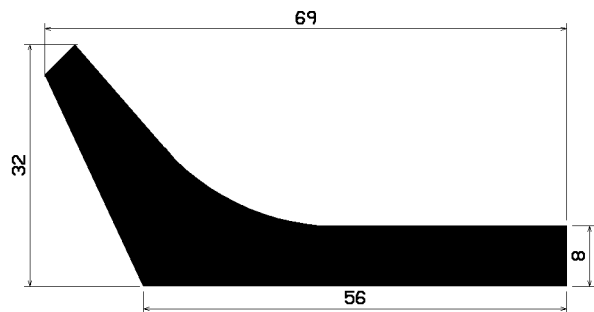

Wi2379  
Si/t/ 8206

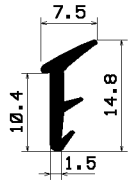

VP2381  
Si/t/ 8239

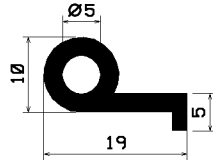

FN2395  
Si/rb/ 8266

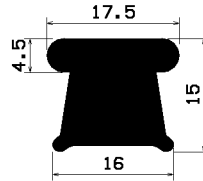

S2407  
Si/w/ 8281

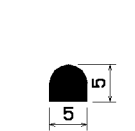

HR2418  
Si/rb/ 8320

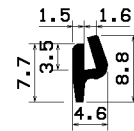

TU1-2438  
Si/s/ 7397

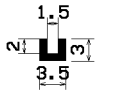

TU1-2451  
Si/t/ 7421

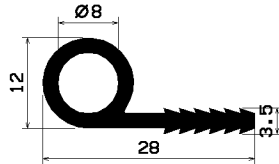

FN2454  
Si/rb/ 7420

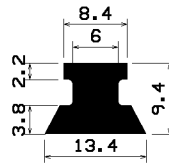

S2466  
Si/rb/ 7454

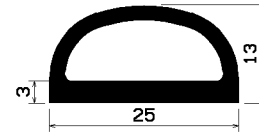

HR2485  
Si/w/ 7514

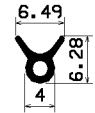

S2507  
Si/t/ 8402

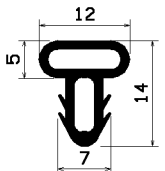

SC2516  
Si/s/ 8569

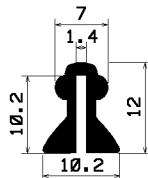

S2535  
Si/t/ 8616

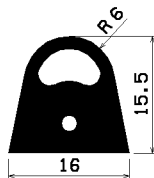

HR2536  
Si/bl/ 8602

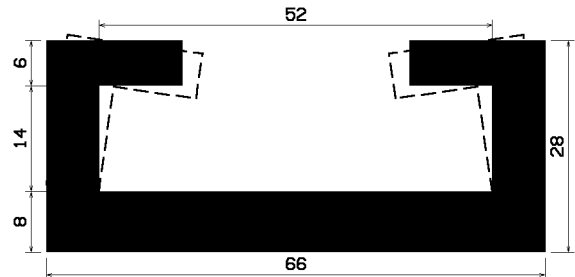

SE2559  
Si/r/ 8672

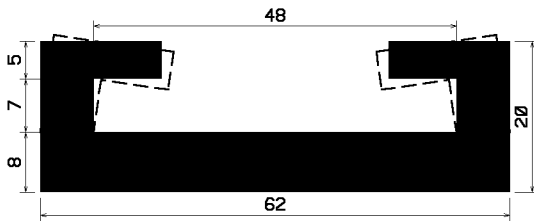

SE2560  
Si/r/ 8673

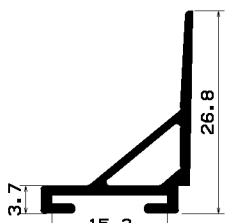

S2582  
Si/s/ 8725

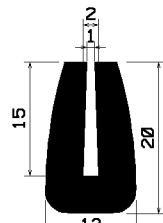

TU1-2587  
Si/t/ 8730

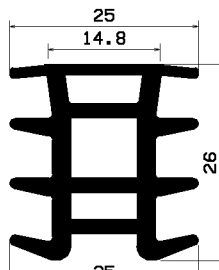

S2627  
Si/s/ 8830

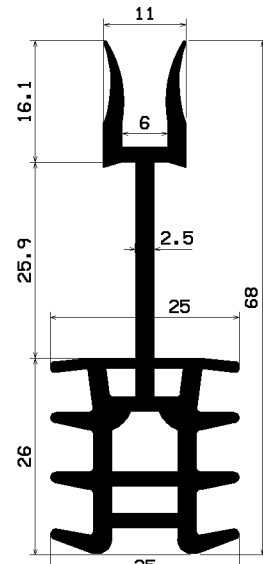

S2628  
Si/s/ 8831