

---

---

# **gummi-plast**

Schild GmbH & Co.KG

Gernsheim

---

---

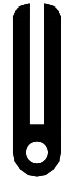

**Profiles of rubber, sponge rubber,  
silicone, foam silicone**

**D-64579 Gernsheim - Germany**

**Otto-Hahn-Straße 12**

**Telefon +49 (0) 62 58 / 932250**

**Telefax +49 (0) 62 58 / 4997**

**e-mail: [schild@gummi-plast.de](mailto:schild@gummi-plast.de)**

**internet: <http://www.gummi-plast.de>**

## screen strip profiles

## list no. 528

last modification: 16.09.2004



SL

---

# Legend

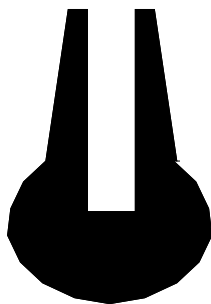

**SL 9999**

*Profile-No.*

means

## Quality

|     |                        |
|-----|------------------------|
| CR  | Neoprene               |
| EP  | EPDM                   |
| NBR | Perbunan               |
| NK  | Natural rubber         |
| Si  | Silicone               |
| SPS | Foam silicone          |
| FPM | VITON®                 |
| PVC | Soft-PVC               |
| EVA | Ethylenvinylacetat     |
| SBR | Buna (Styrol-Butadien) |

## Colours

|    |                   |
|----|-------------------|
| s  | black             |
| g  | grey              |
| w  | white             |
| az | anthracite        |
| bg | beige             |
| br | brown             |
| hg | light-grey        |
| rb | red-brown         |
| t  | translucent       |
| r  | red               |
| x  | colour selectable |

® = Entered registered trade mark of the company DuPont

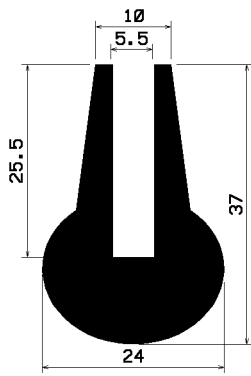

SL2017

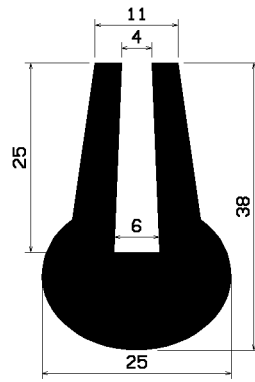

SL2018

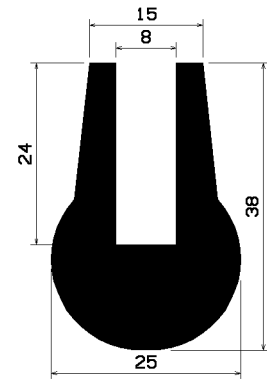

SL2019

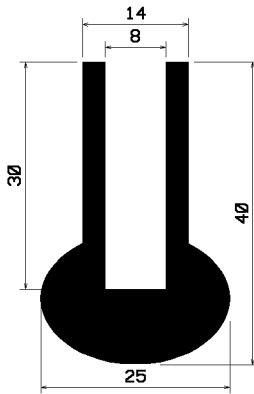

SL2020

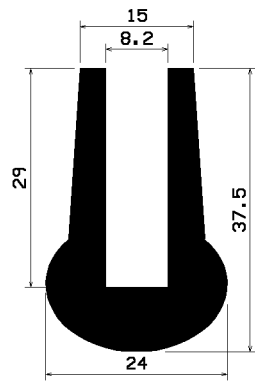

SL2021

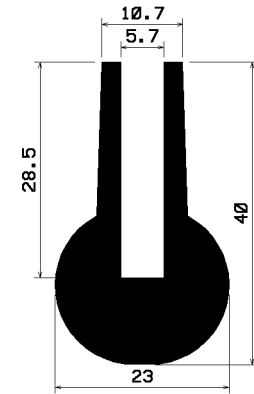

SL2022

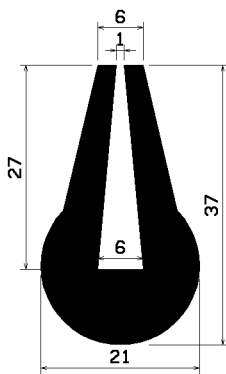

SL2023

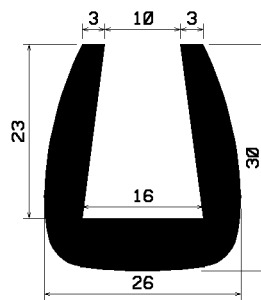

SL2024

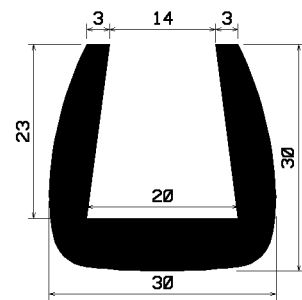

SL2025

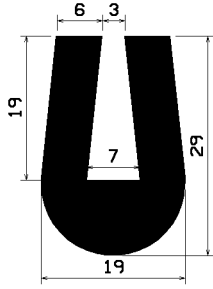

TU1-112

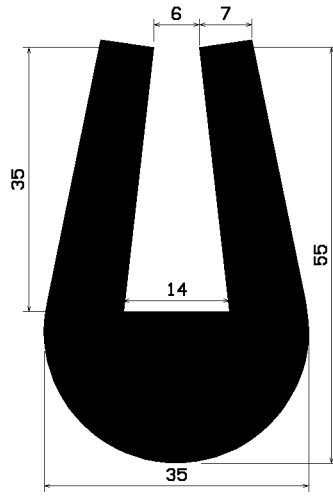

TU1-338

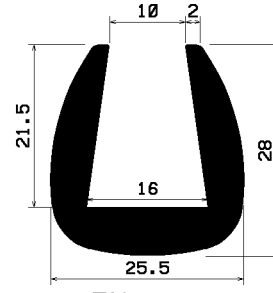

TU1-734

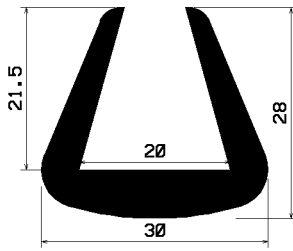

TU1-846

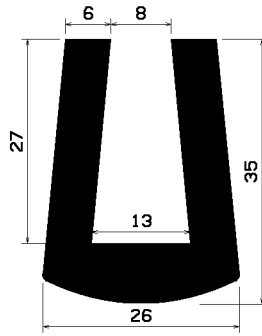

TU1-1202

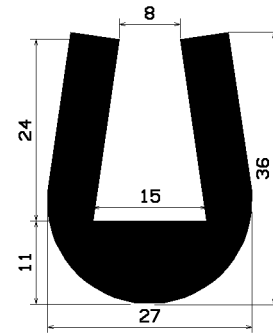

TU1-1617

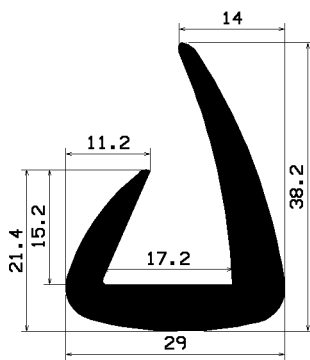

TU1-1946