

---

---

# gummi-plast

Schild GmbH & Co.KG

Gernsheim

---

---



**Profile aus Gummi, Moosgummi,  
Silikon, Schaum silikon**

D-64579 Gernsheim

Otto-Hahn-Straße 12

Telefon 0 62 58 / 932250

Telefax 0 62 58 / 4997

e-mail: [schild@gummi-plast.de](mailto:schild@gummi-plast.de)

internet: <http://www.gummi-plast.de>

## Technische U-Profile

### Liste Nr. 498

# Vollgummi

---

## Zeichenerklärung

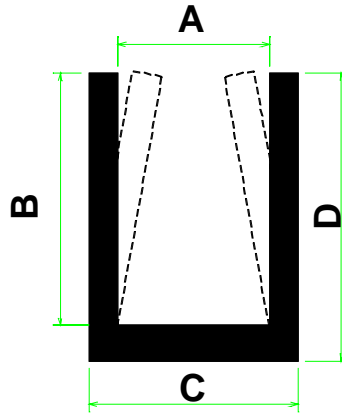

**TU1-9999**

bedeutet

*Profil-Nr.*

**EP / s / 9999**

bedeutet

*Qualität / Farbe / Artikel-Nr. / (Artikel-Nr. mit es.sk)*

----- = Vorspannung  
es.sk = einseitig selbstklebend

### Qualität

CR	Neoprene
EP	EPDM
NBR	Perbunan
NK	Naturkautschuk
Si	Silikon
SPS	Silikonschaum
FPM	VITON®
PVC	Weich-PVC
EVA	Ethylenvinylacetat
SBR	Buna (Styrol-Butadien)

### Farbe

s	schwarz
g	grau
w	weiß
az	anthrazit
bg	beige
br	braun
hg	hellgrau
rb	rotbraun
t	transparent
r	rot
x	Farbe wählbar

VITON® = Eingetragenes Warenzeichen der Firma DuPont

# Vollgummi

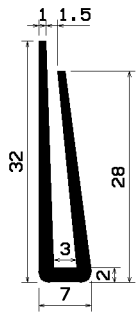

TU1-040  
PVC/x/1799

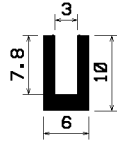

TU1-070  
EP/s/ 1458

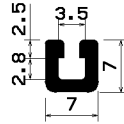

TU1-111  
PVC/x/1800

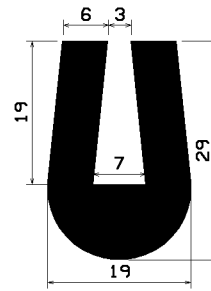

TU1-112  
EP/s/ 0969

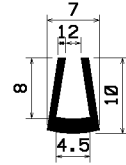

TU1-113  
Si/x/ 1801

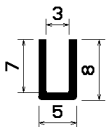

TU1-116  
PVC/l/ 0059  
PVC/x/1802

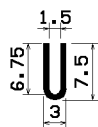

TU1-121  
NK/g/ 0972  
NK/bg/1396  
EP/g/ 2319  
EP/s/ 7721

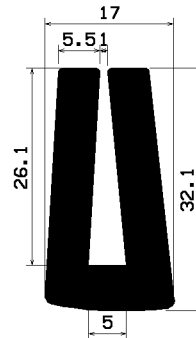

TU1-154  
EP/s/ 0973

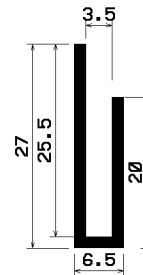

TU1-181  
EP/s/ 0974  
NBR/s/ 7318

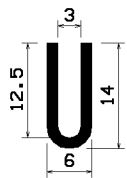

TU1-186  
EP/s/ 0975  
Si/t/ 5861

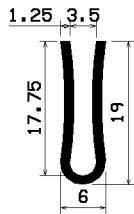

TU1-228  
EP/s/ 0976  
Si/t/ 5862

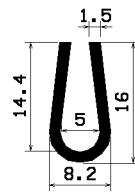

TU1-229  
EP/s/ 0977

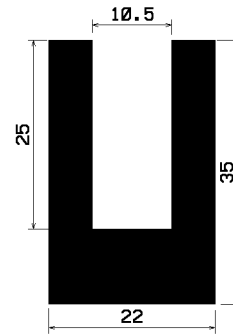

TU1-233  
EP/s/ 0978

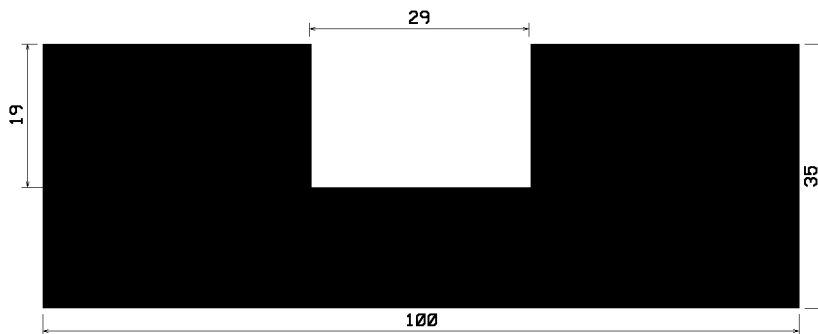

TU1-246  
EP/s/ 0979

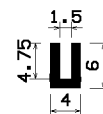

TU1-290  
EP/s/ 0980

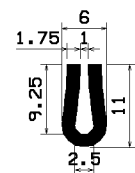

TU1-292  
EP/g/ 0981

# Vollgummi

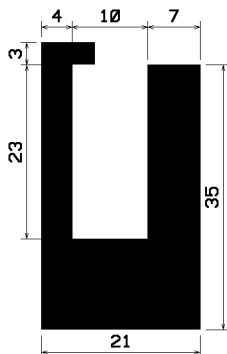

TU1-299  
EP/s/ 0982

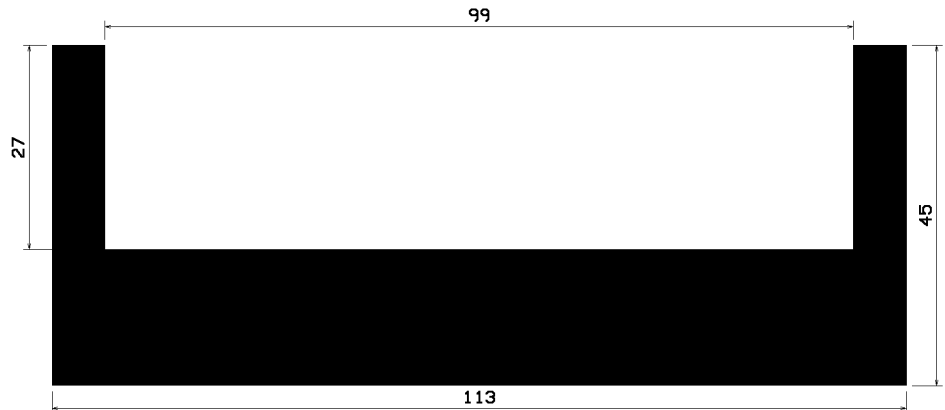

TU1-304  
EP/s/ 0983

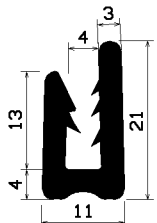

TU1-305  
EVA/x/ 1803

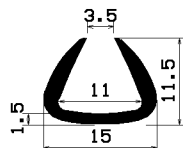

TU1-306  
PVC/x/ 1804

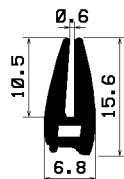

TU1-317  
Si/x/ 1805

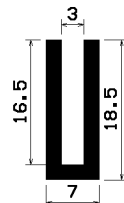

TU1-320  
EP/s/ 0987

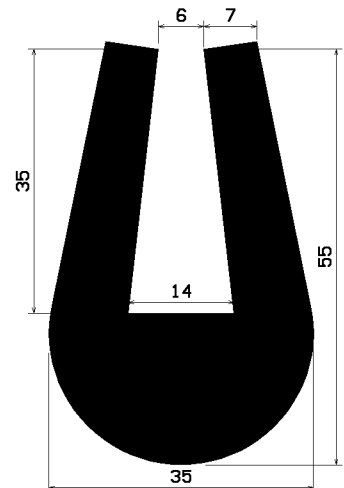

TU1-338  
EP/s/ 0988

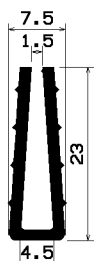

TU1-350  
EP/s/ 0989

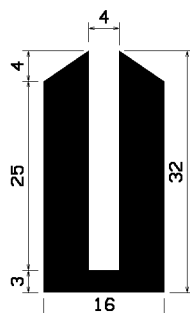

TU1-367  
EP/s/ 0990

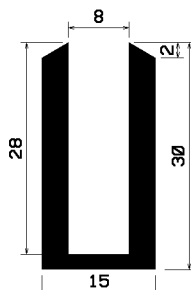

TU1-368  
EP/s/ 0991

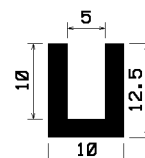

TU1-370  
EP/s/ 0992

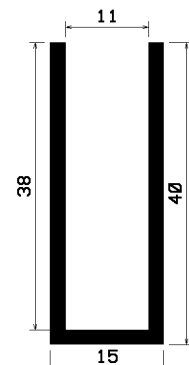

TU1-371  
EP/s/ 0993

# Vollgummi

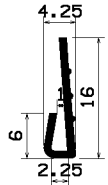

TU1-378  
EP/s/ 0994

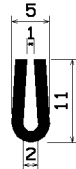

TU1-396  
EP/s/ 6011

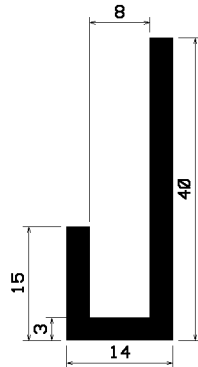

TU1-402  
EP/s/ 0996

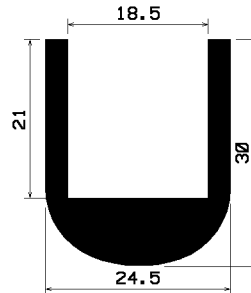

TU1-409  
EP/s/ 0997

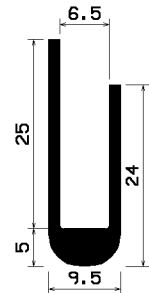

TU1-418  
NBR/s/ 0998

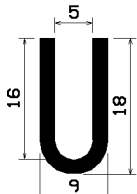

TU1-421  
EP/s/ 0999  
EP/w/ 2029

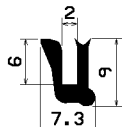

TU1-426  
NBR/g/ 1000

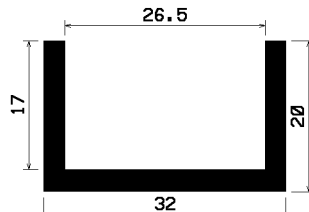

TU1-435  
EP/s/ 1001

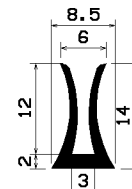

TU1-444  
EP/s/ 1002

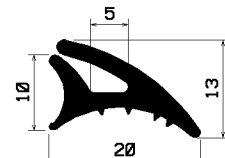

TU1-469  
EP/s/ 1003

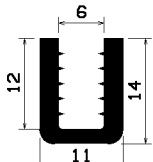

TU1-483  
PVC/s/ 1807

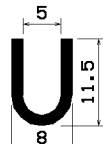

TU1-484  
EP/g/ 1005  
EP/s/ 7146

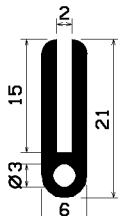

TU1-529  
EP/s/ 1006  
Si/s/ 4120

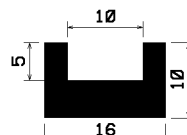

TU1-533  
EP/s/ 1007

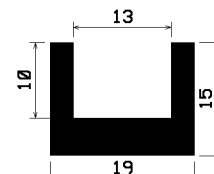

TU1-534  
EP/s/ 1008

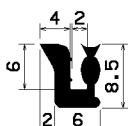

TU1-545  
NBR/bg/ 1009

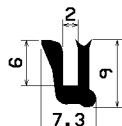

TU1-561  
EP/s/ 1010

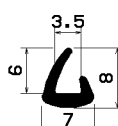

TU1-578  
EP/s/ 1011

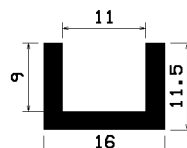

TU1-596  
EP/s/ 1012

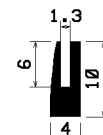

TU1-598  
EP/w/ 1013

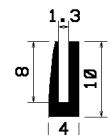

TU1-599  
EP/w/ 1014

# Vollgummi

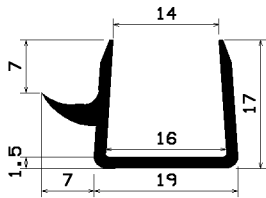

TU1-603  
EP/w/ 1015

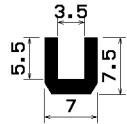

TU1-605  
EP/s/ 1506

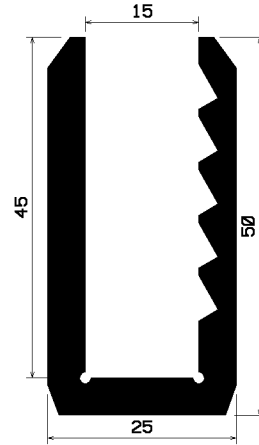

TU1-608  
EP/s/ 1360

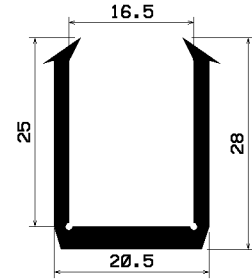

TU1-611  
EP/s/ 1362

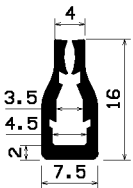

TU1-614  
EP/s/ 1528

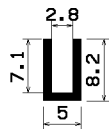

TU1-620  
EP/s/ 1529

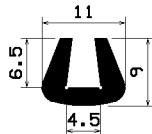

TU1-643  
PVC/s/ 1809

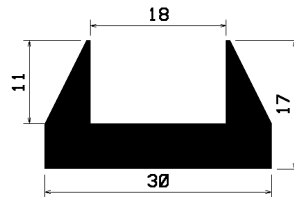

TU1-648  
Si/r/ 1810

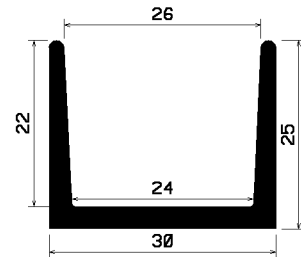

TU1-667  
EP/s/ 1489

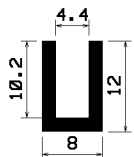

TU1-672  
EP/s/ 1491

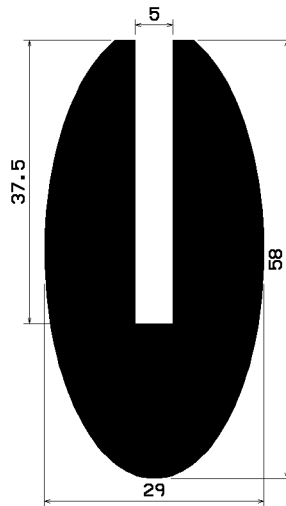

TU1-694  
EP/s/ 1916

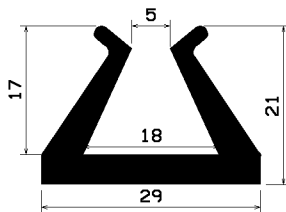

TU1-676  
EP/g/ 1566

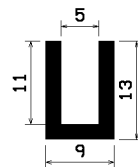

TU1-695  
EP/s/ 3078

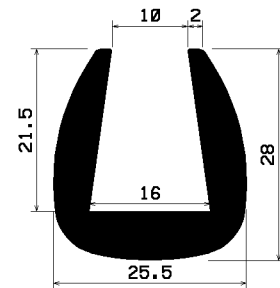

TU1-734  
EP/s/ 2101

# Vollgummi

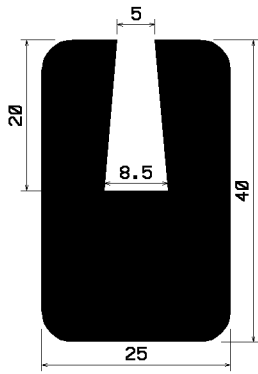

TU1-736  
EP/s/ 2106

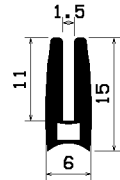

TU1-746  
EP/s/ 2185

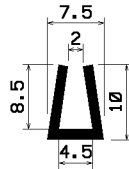

TU1-755  
Si/ / 2213

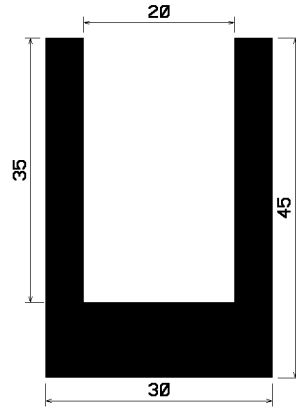

TU1-756  
EP/s/ 2228

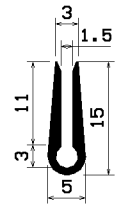

TU1-758  
EP/s/ 2227

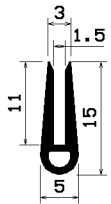

TU1-764  
EP/s/ 2268

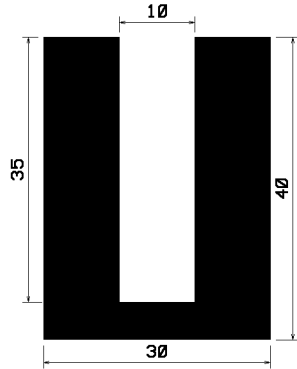

TU1-772  
EP/s/ 2431

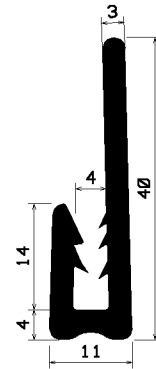

TU1-781  
EP/s/ 2545

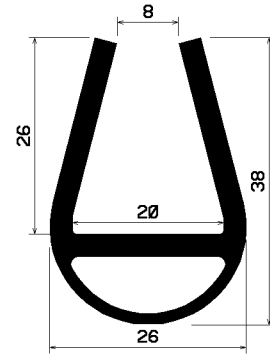

TU1-796  
EP/s/ 3610

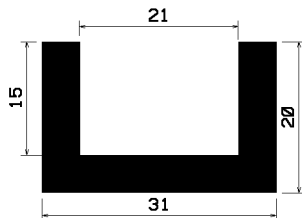

TU1-798  
EP/w/ 2635  
EP/s/ 5465

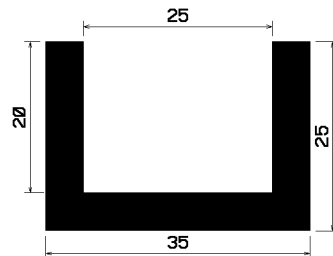

TU1-799  
EP/s/ 2633

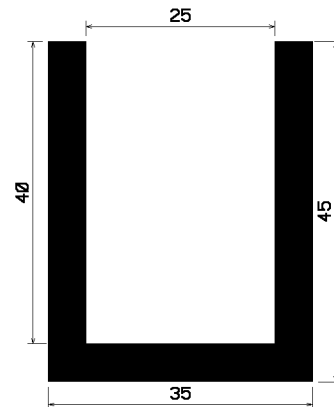

TU1-801  
EP/s/ 2631

# Vollgummi

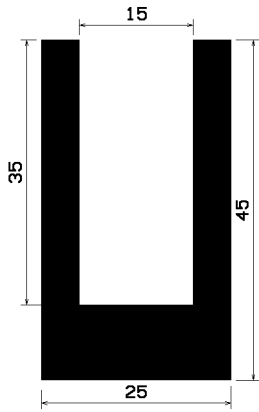

TU1-802  
EP/s/ 2630

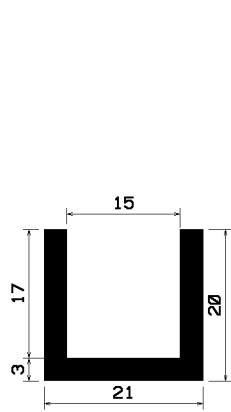

TU1-805  
EP/s/ 2629

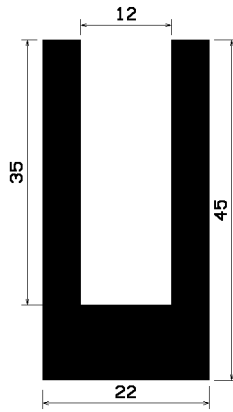

TU1-806  
EP/s/ 2628

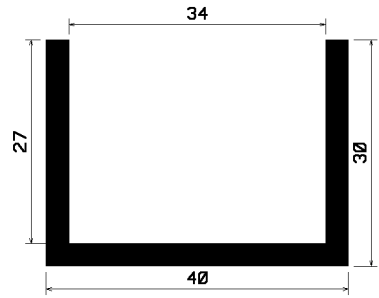

TU1-815  
EP/s/ 2644

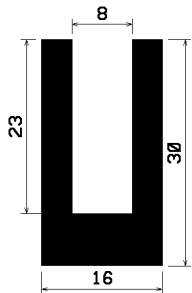

TU1-817  
EP/s/ 2654

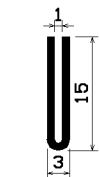

TU1-843  
EP/s/ 2861

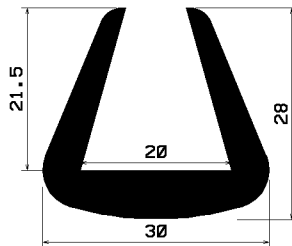

TU1-846  
EP/s/ 2922

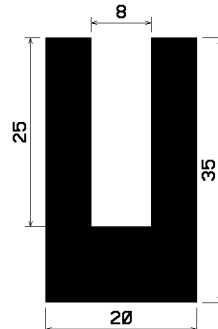

TU1-851  
Si/rb/ 2943

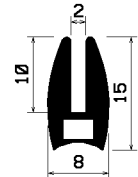

TU1-852  
EP/s/ 2966

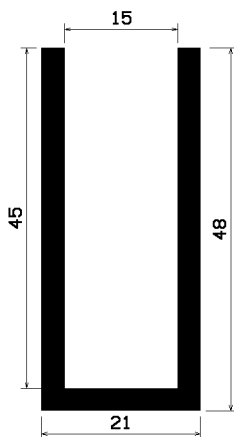

TU1-854  
EP/s/ 2951

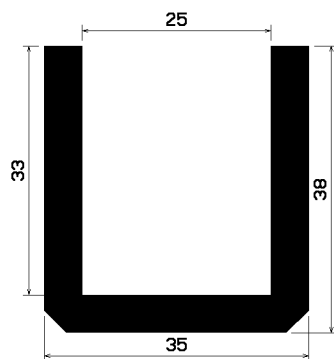

TU1-876  
EP/s/ 2986

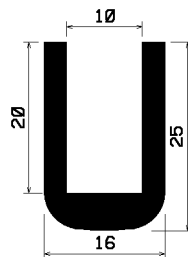

TU1-879  
EP/s/ 3024

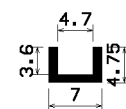

TU1-880  
NBR/s/ 3025

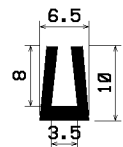

TU1-882  
Si/t/ 3033



# Vollgummi

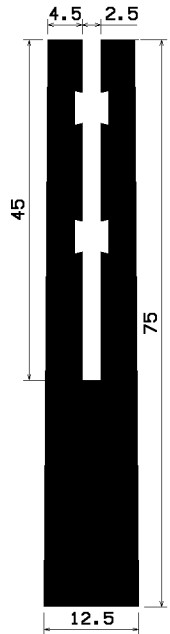

TU1-909  
EP/s/ 3083

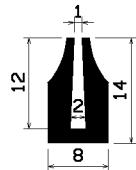

TU1-889  
EP/s/ 3046

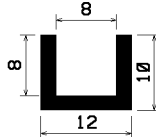

TU1-894  
EP/s/ 3066

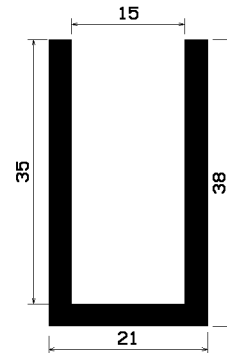

TU1-899  
EP/s/ 3064

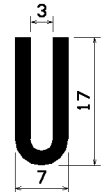

TU1-905  
EP/s/ 3087

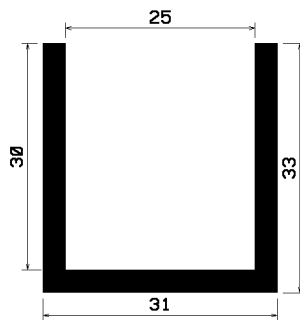

TU1-924  
EP/s/ 3130

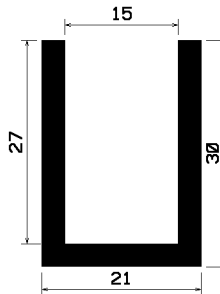

TU1-931  
EP/s/ 3162

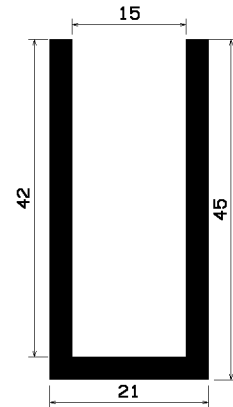

TU1-932  
EP/s/ 3161

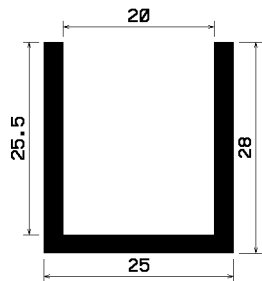

TU1-944  
EP/s/ 3202

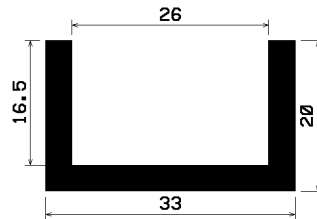

TU1-946  
EP/s/ 3203

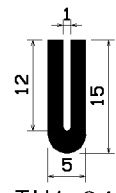

TU1-947  
EP/s/ 3217  
EP/g/ 5363

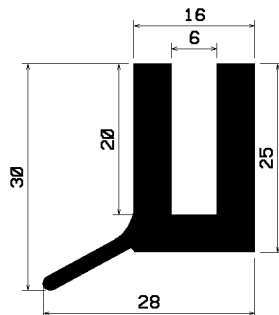

TU1-948  
SBR/s/ 3208

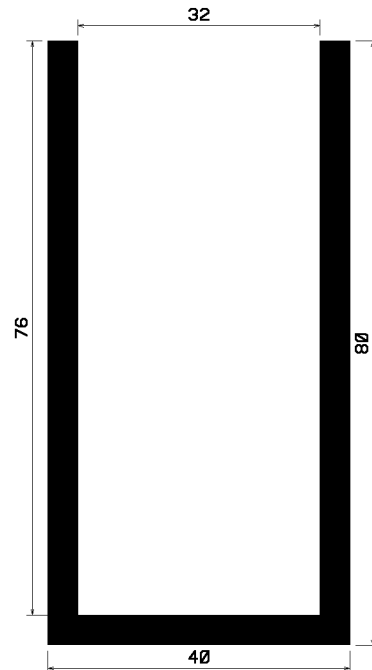

TU1-957  
EP/s/ 3248

# Vollgummi

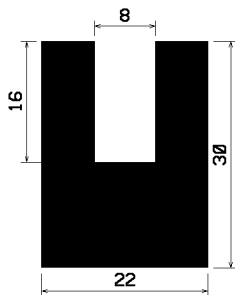

TU1-968  
EP/s/ 3282

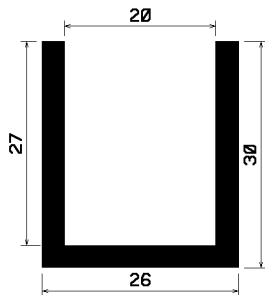

TU1-971  
EP/s/ 3292

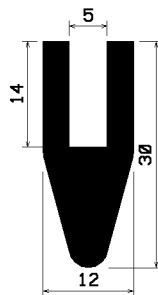

TU1-987  
EP/s/ 3320

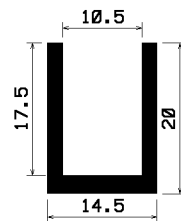

TU1-1000  
EP/s/ 3345

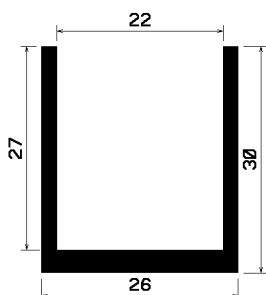

TU1-1006  
EP/s/ 3355

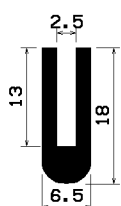

TU1-1011  
Si/t/ 3368  
Si/s/ 4299

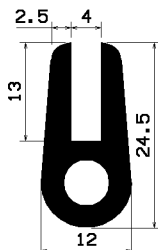

TU1-1022  
Si/t/ 3398

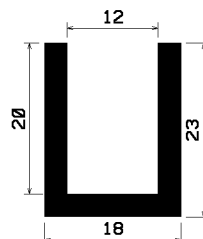

TU1-1023  
EP/s/ 3395

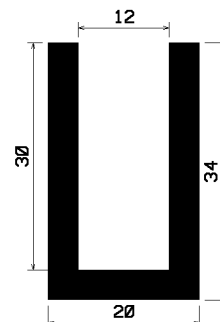

TU1-1024  
EP/s/ 3396

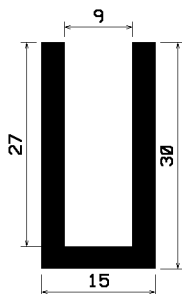

TU1-1028  
EP/s/ 3408

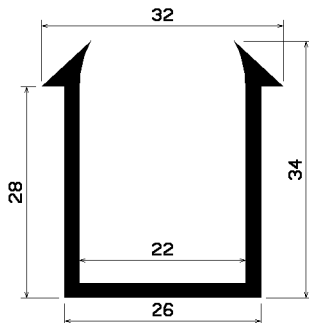

TU1-1030  
EP/s/ 3407

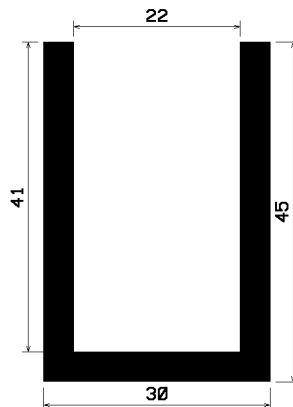

TU1-1033  
EP/s/ 3413

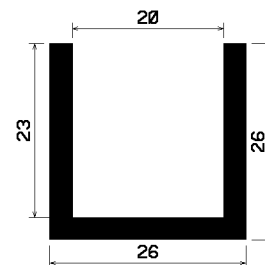

TU1-1034  
EP/s/ 3414

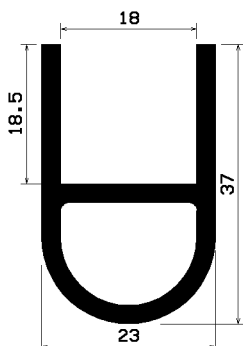

TU1-1035  
EP/s/ 3415

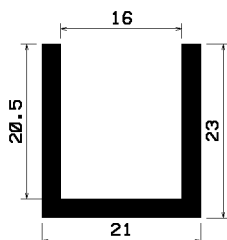

TU1-1036  
EP/s/ 3418

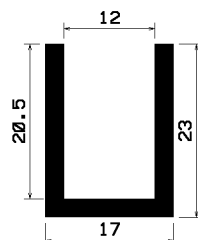

TU1-1042  
EP/s/ 3423

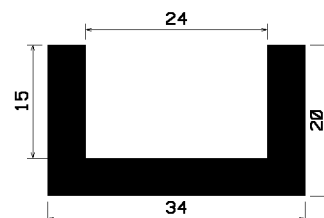

TU1-1043  
EP/s/ 3431

# Vollgummi

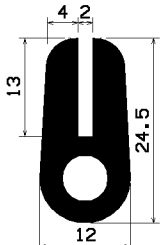

TU1-1044  
Si/I/ 3425

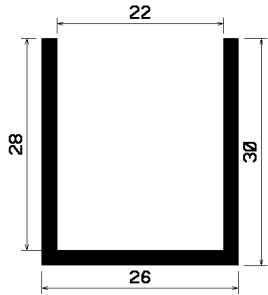

TU1-1045  
EP/s/ 3433

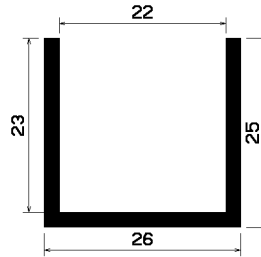

TU1-1046  
EP/s/ 3434

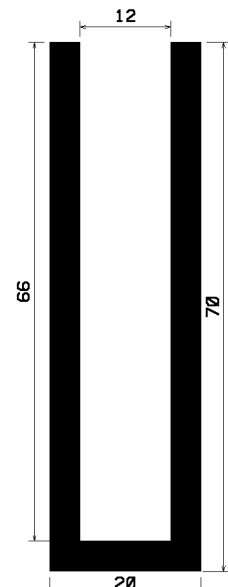

TU1-1048  
EP/s/ 3436

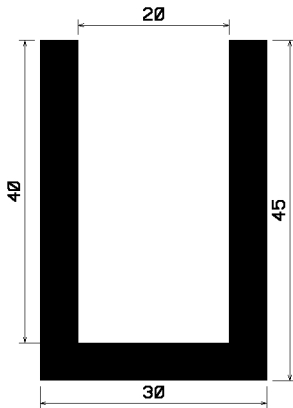

TU1-1049  
EP/s/ 3444

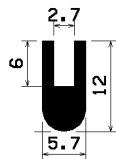

TU1-1050  
Si/I/ 3447

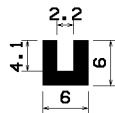

TU1-1051  
EP/s/ 3452

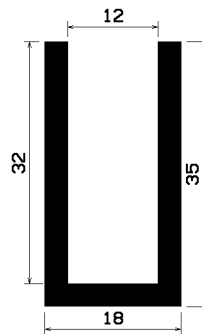

TU1-1064  
EP/s/ 3503

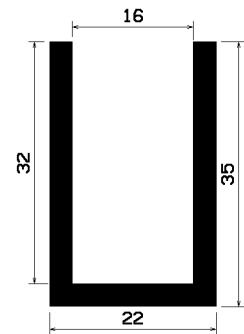

TU1-1065  
EP/s/ 3498

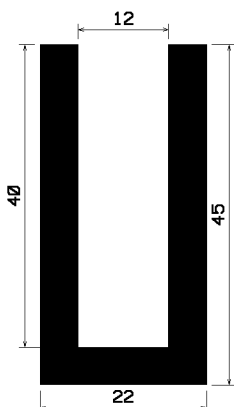

TU1-1066  
EP/s/ 3499

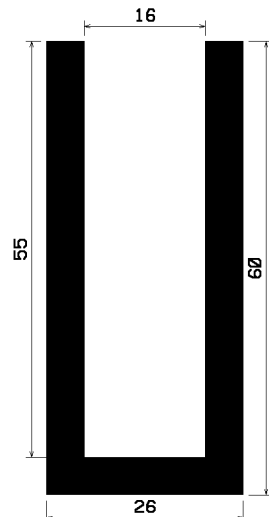

TU1-1067  
EP/s/ 3504

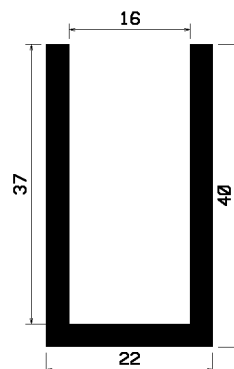

TU1-1068  
EP/s/ 3500

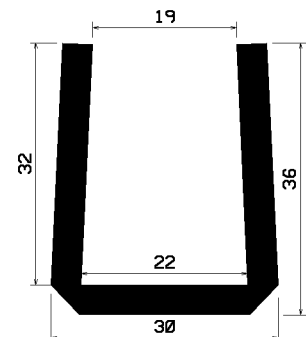

TU1-1070  
EP/s/ 3501

# Vollgummi

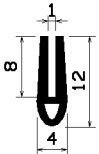

TU1-1071  
EP/s/ 3506

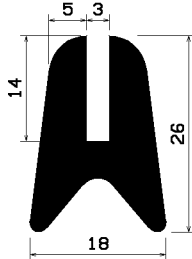

TU1-1074  
EP/s/ 3531

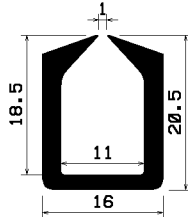

TU1-1075  
NBR/s/ 3530

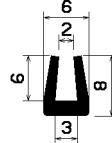

TU1-1078  
EP/s/ 3538

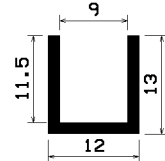

TU1-1080  
EP/s/ 3542

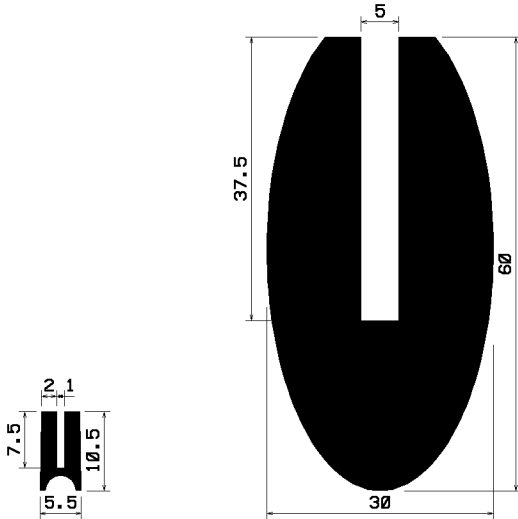

TU1-1082  
EP/s/ 3561

TU1-1083  
Si/I/ 3558

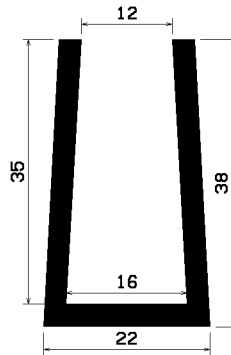

TU1-1089  
EP/s/ 3602

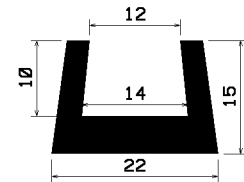

TU1-1090  
EP/s/ 3603

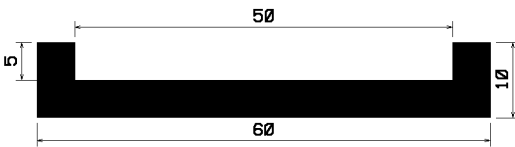

TU1-1101  
Si/w/ 3633

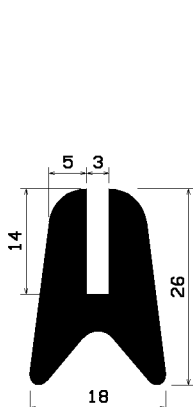

TU1-1109  
Si/s/ 3658

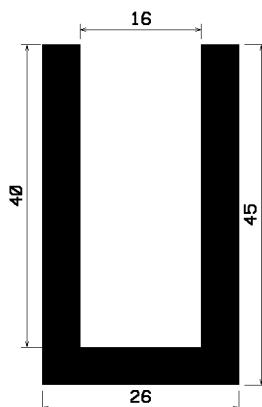

TU1-1111  
EP/s/ 3660

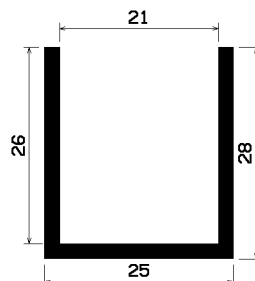

TU1-1113  
EP/s/ 3667

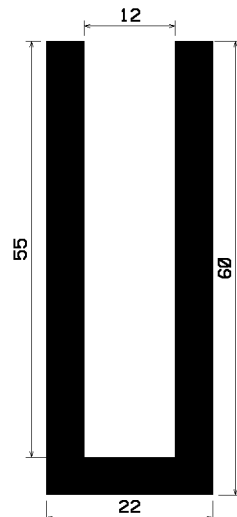

TU1-1117  
EP/s/ 3669

# Vollgummi

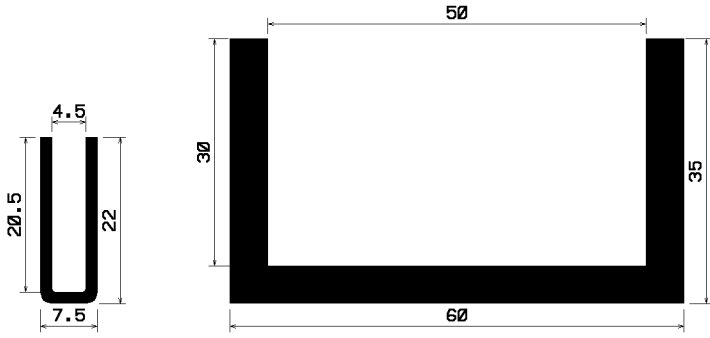

TU1-1128  
EP/s/ 3721

TU1-1130  
EP/s/ 3726

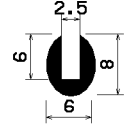

TU1-1132  
Si/I/ 3737

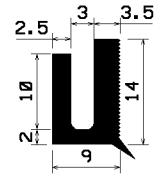

TU1-1143  
EP/s/ 3775

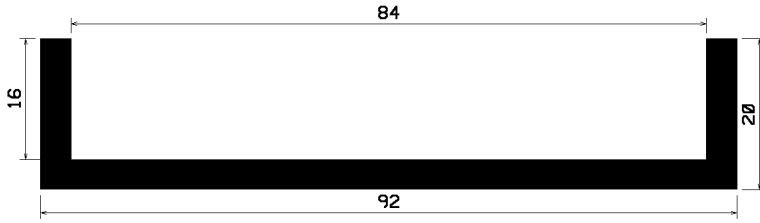

TU1-1148  
EP/s/ 3782

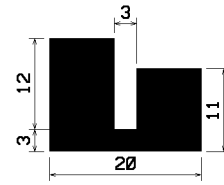

TU1-1152  
EP/s/ 3805

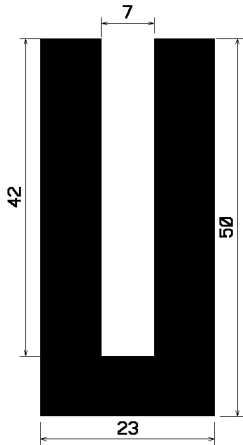

TU1-1164  
Si/s/ 3840

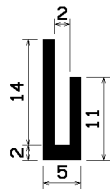

TU1-1181  
EP/s/ 3914

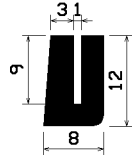

TU1-1182  
Si/I/ 3915

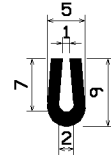

TU1-1184  
CR/s/ 3943

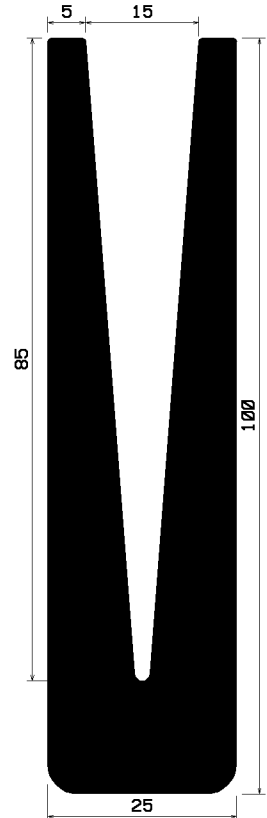

TU1-1228  
EP/g/ 4080

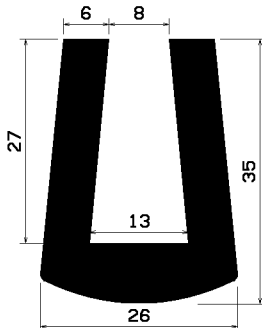

TU1-1202  
EP/s/ 4056

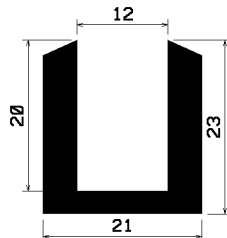

TU1-1204  
EP/s/ 3959

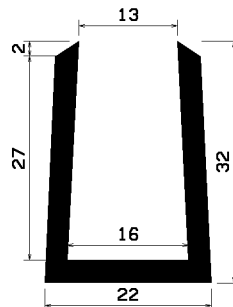

TU1-1222  
EP/s/ 4016

# Vollgummi

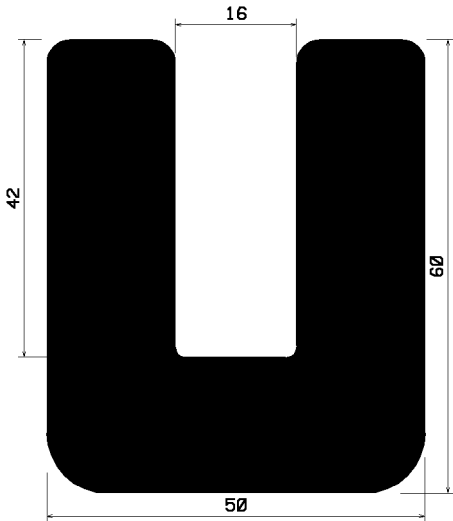

TU1-1231  
NBR/s/4073

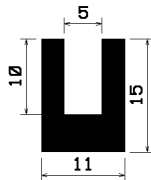

TU1-1263  
Si/I/ 4097

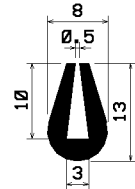

TU1-1264  
Si/rb/4108

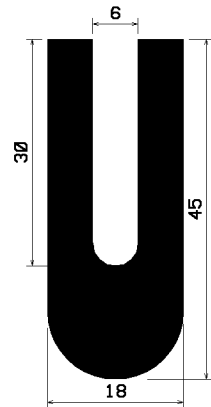

TU1-1276  
EP/s/ 4139

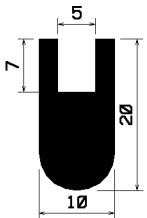

TU1-1278  
EP/s/ 4069

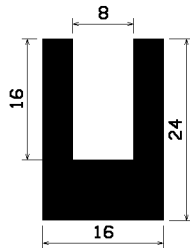

TU1-1281  
EP/s/ 4186

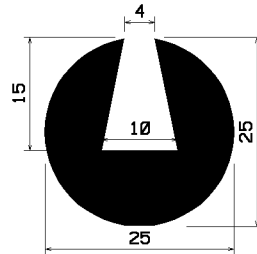

TU1-1286  
EP/s/ 4189

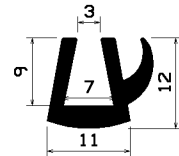

TU1-1292  
EP/s/ 4169

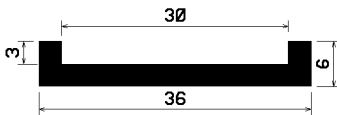

TU1-1298  
EP/s/ 4199

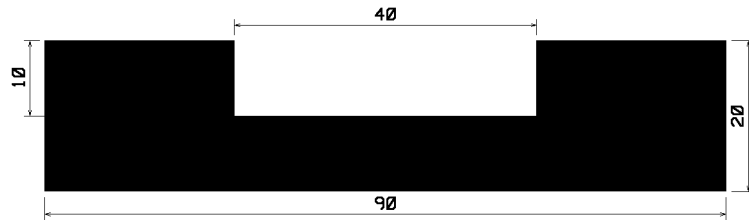

TU1-1324  
EP/s/ 1138

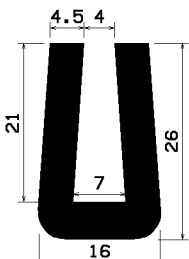

TU1-1325  
CR/s/ 1068

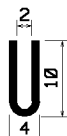

TU1-1329  
EP/s/ 1167

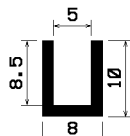

TU1-1332  
EP/s/ 1161

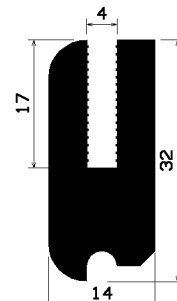

TU1-1335  
EP/s/ 1383

# Vollgummi

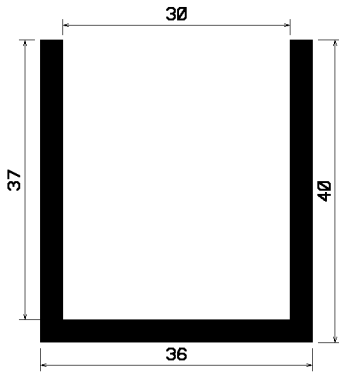

TU1-1353  
EP/s/ 1239

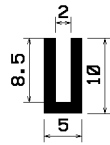

TU1-1363  
EP/s/ 1294

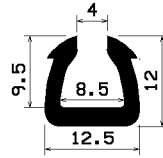

TU1-1370  
EP/s/ 1325

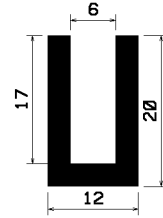

TU1-1382  
EP/s/ 1864

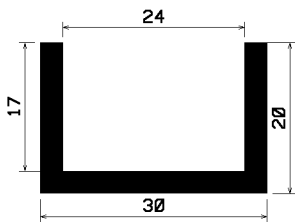

TU1-1393  
EP/s/ 2203

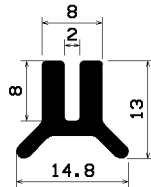

TU1-1396  
Si/t/ 2199

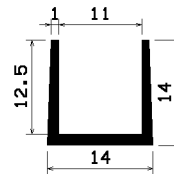

TU1-1404  
EP/s/ 1300

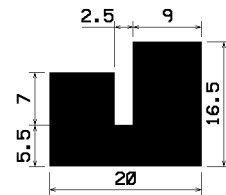

TU1-1407  
NK/s/ 3793

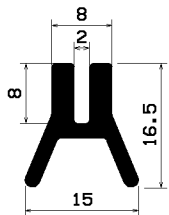

TU1-1408  
Si/t/ 3794

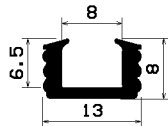

TU1-1416  
EP/s/ 4253

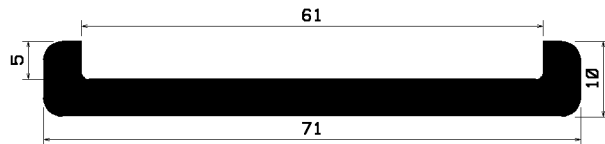

TU1-1419  
EP/s/ 4256

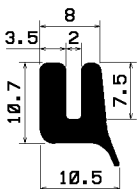

TU1-1429  
EP/s/ 4330

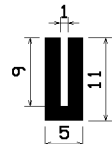

TU1-1446  
Si/bg/4450

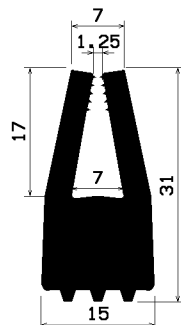

TU1-1447  
EP/s/ 4280

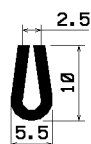

TU1-1462  
EP/s/ 4545

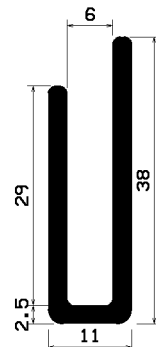

TU1-1470  
EP/s/ 4585

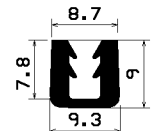

TU1-1480  
EP/s/ 4626

# Vollgummi

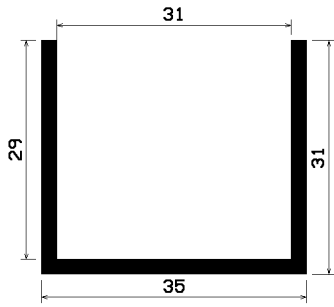

TU1-1490  
EP/s/ [4677](#)

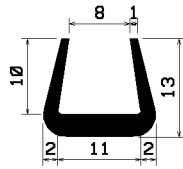

TU1-1495  
SBR/s/ [4690](#)

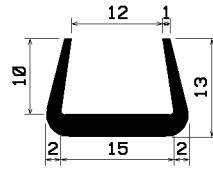

TU1-1496  
SBR/s/ [4691](#)

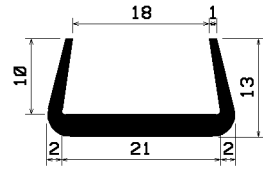

TU1-1497  
SBR/s/ [4692](#)

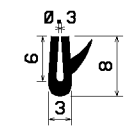

TU1-1501  
EP/s/ [4739](#)

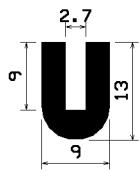

TU1-1523  
EP/s/ [4738](#)

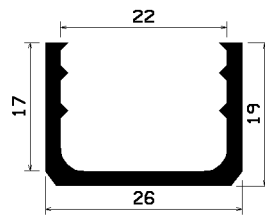

TU1-1535  
EP/s/ [4763](#)

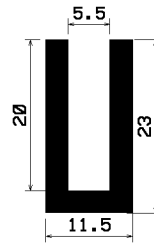

TU1-1536  
EP/s/ [4860](#)

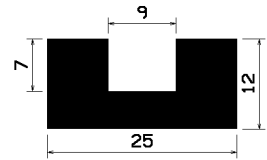

TU1-1541  
EP/s/ [4774](#)

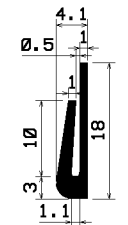

TU1-1565  
EP/s/ [4892](#)

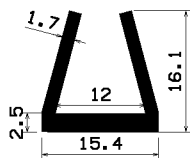

TU1-1572  
EP/s/ [5161](#)

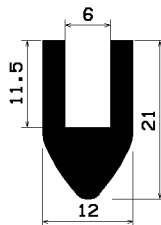

TU1-1598  
NBR/g/ [5169](#)

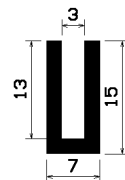

TU1-1599  
EP/s/ [5242](#)

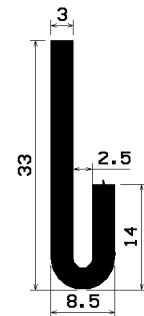

TU1-1606  
EP/s/ [4795](#)

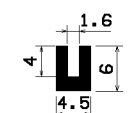

TU1-1611  
Si/rb/ [5913](#)

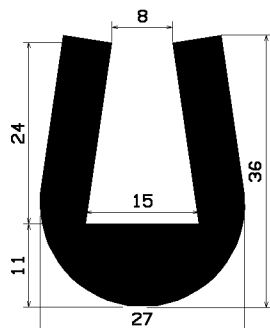

TU1-1617  
EP/s/ [5333](#)

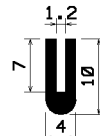

TU1-1618  
EP/g/ [5355](#)

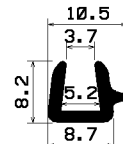

TU1-1619  
EP/s/ [5365](#)

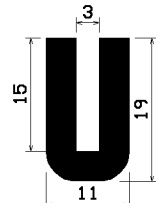

TU1-1633  
Si/t/ [5386](#)



# Vollgummi

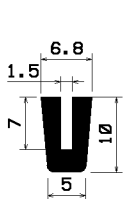

TU1-1636  
EP/s/ 5391

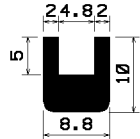

TU1-1654  
EP/g/ 5656

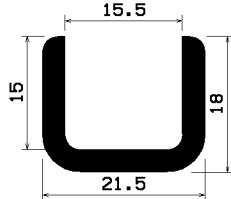

TU1-1657  
EP/s/ 5470

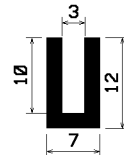

TU1-1669  
EP/s/ 5671

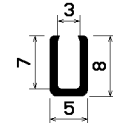

TU1-1687  
EP/g/ 5737

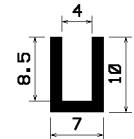

TU1-1688  
EP/s/ 5732

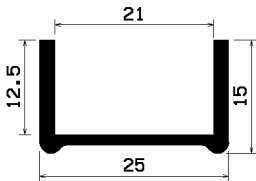

TU1-1696  
NBR/s/ 5845

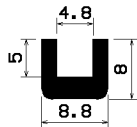

TU1-1709  
EP/w/ 5840

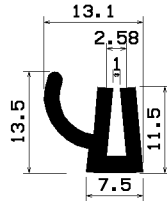

TU1-1718  
EP/s/ 5943

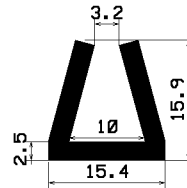

TU1-1746  
EP/s/ 5979

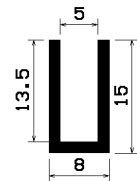

TU1-1751  
NBR/s/ 6007

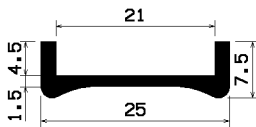

TU1-1755  
NBR/s/ 6001

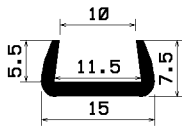

TU1-1761  
EP/s/ 6022

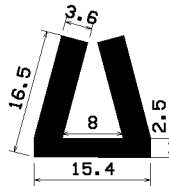

TU1-1803  
EP/s/ 6123

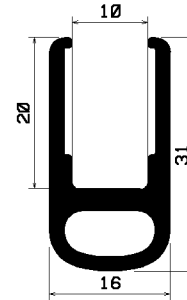

TU1-1813  
EP/s/ 6145

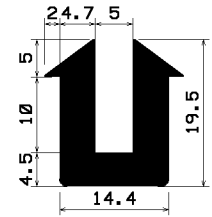

TU1-1820  
EP/s/ 6151

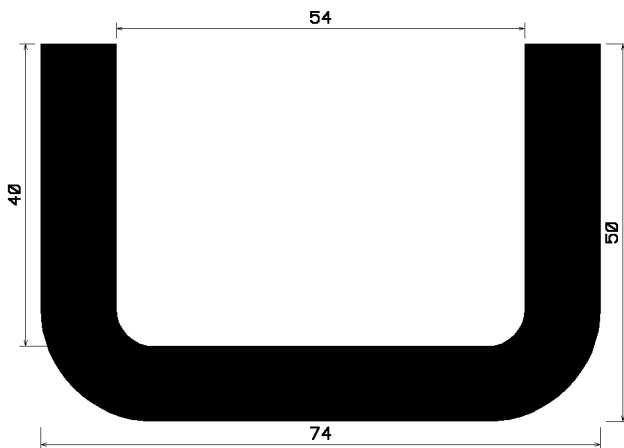

TU1-1824  
EP/s/ 6221

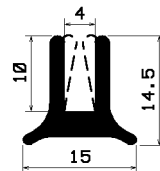

TU1-1827  
EP/s/ 6195

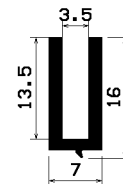

TU1-1838  
Si/az/ 6207

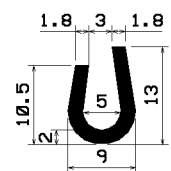

TU1-1848  
Si/l/ 6456

# Vollgummi

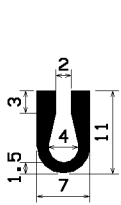

TU1-1849  
EP/s/ 6463

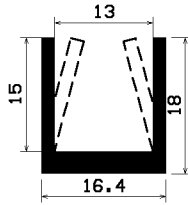

TU1-1852  
EP/s/ 6474

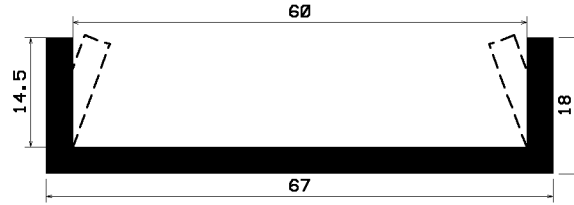

TU1-1873  
EP/s/ 6536

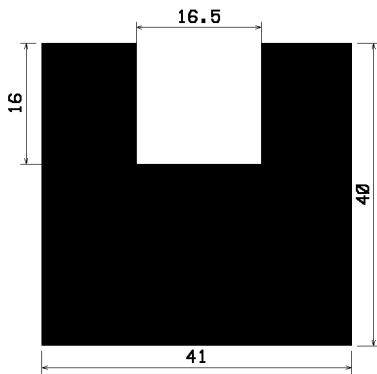

TU1-1877  
CR/s/ 6498

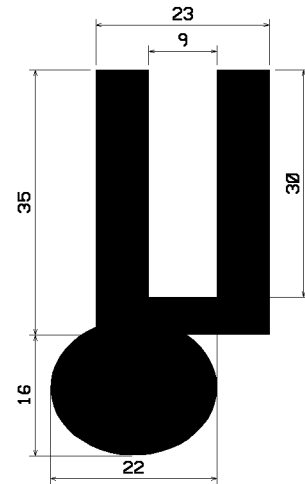

TU1-1881  
EP/s/ 6546

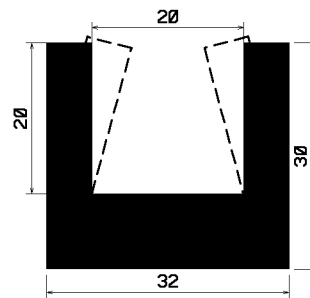

TU1-1886  
EP/s/ 6551

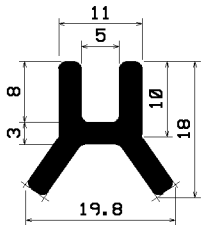

TU1-1890  
Si/s/ 6611

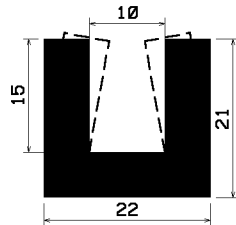

TU1-1898  
Si/l/ 6598

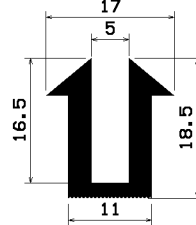

TU1-1909  
EP/s/ 6780

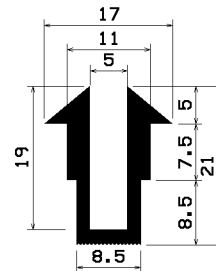

TU1-1910  
EP/s/ 6781

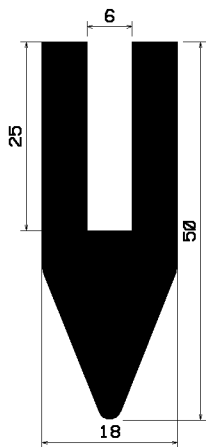

TU1-1916  
NBR/s/ 6823

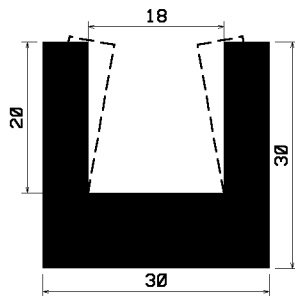

TU1-1921  
EP/s/ 6804

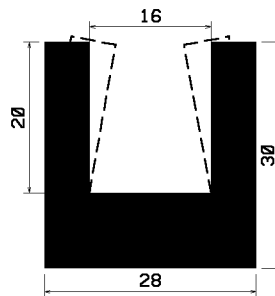

TU1-1922  
EP/s/ 6805

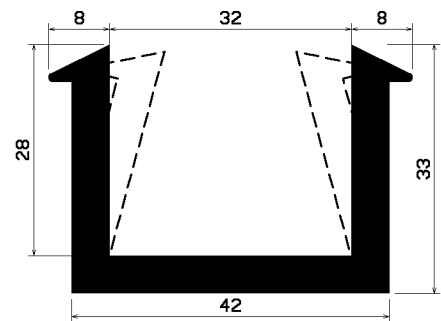

TU1-1935  
EP/s/ 6647

# Vollgummi

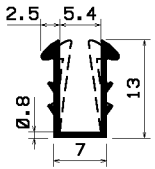

TU1-1942  
EP/s/ 6675

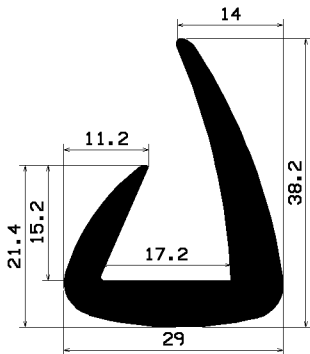

TU1-1946  
EP/s/ 6841

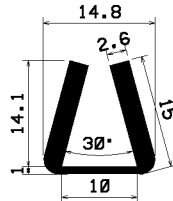

TU1-1954  
EP/s/ 6858

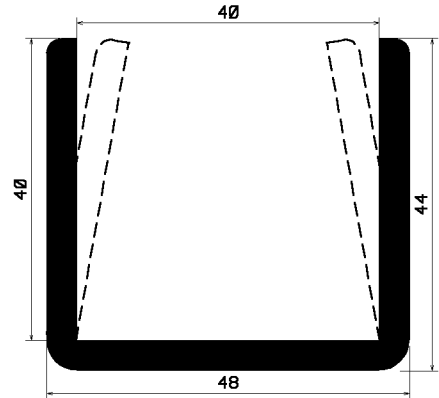

TU1-1995  
EP/s/ 6977

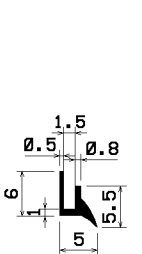

TU1-1998  
Si/g/ 6999

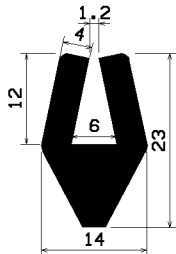

TU1-1999  
EP/s/ 6989

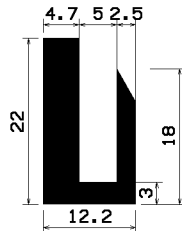

TU1-2008  
EP/s/ 7016

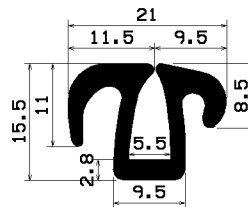

TU1-2026  
EP/s/ 7049

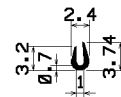

TU1-2028  
PVC/s/ 7034

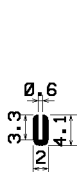

TU1-2031  
EP/s/ 7042

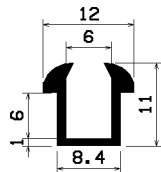

TU1-2033  
EP/s/ 7063

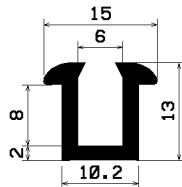

TU1-2034  
EP/s/ 7064

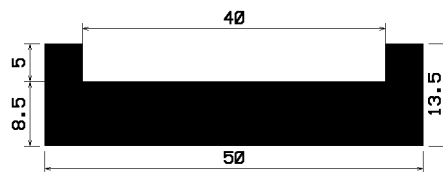

TU1-2045  
EP/s/ 7095

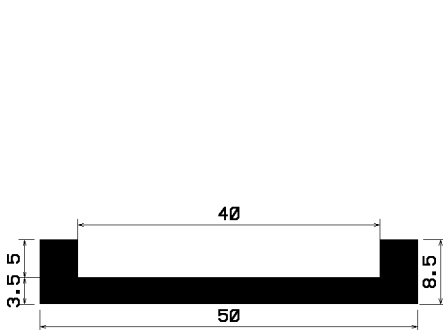

TU1-2046  
EP/s/ 7097

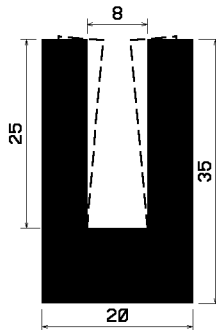

TU1-2047  
Si/s/ 7107

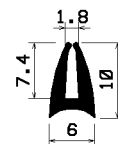

TU1-2048  
FPM/s/ 7110

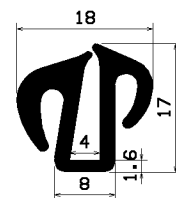

TU1-2053  
EP/s/ 7130

# Vollgummi

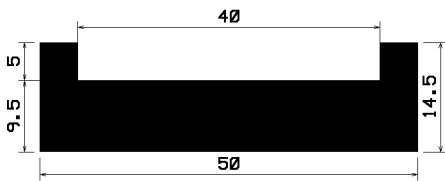

TU1-2056  
EP/s/ 7138

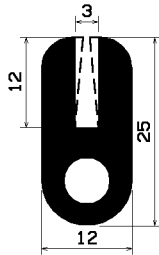

TU1-2061  
Si/I/ 7134

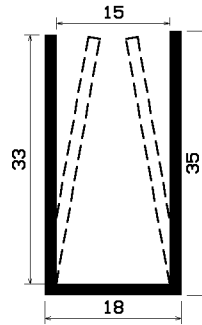

TU1-2063  
EP/s/ 7164

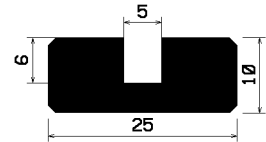

TU1-2070  
EP/s/ 7175

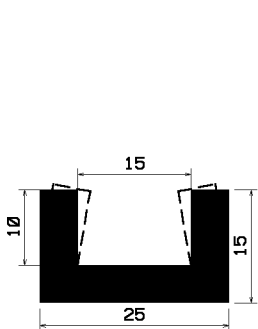

TU1-2075  
EP/s/ 7197

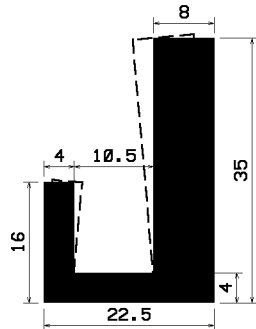

TU1-2077  
EP/s/ 7219

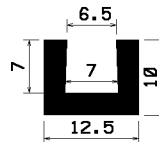

TU1-2081  
EP/s/ 7226

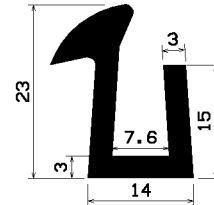

TU1-2084  
EP/s/ 7228

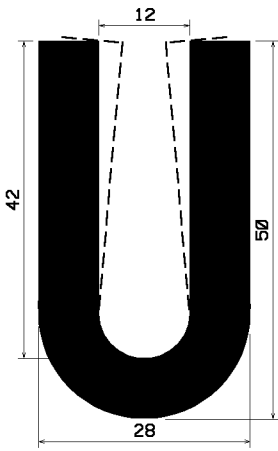

TU1-2091  
EP/s/ 7246

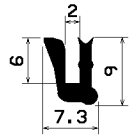

TU1-2122  
Si/I/ 7317

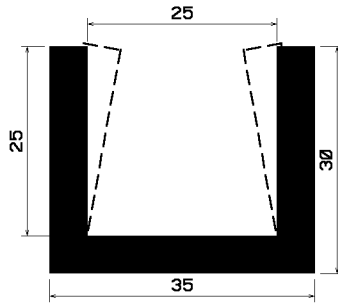

TU1-2125  
Si/I/ 7324

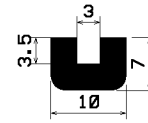

TU1-2129  
EP/s/ 7335

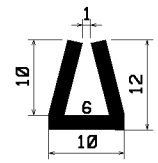

TU1-2130  
NBR/s/ 7333

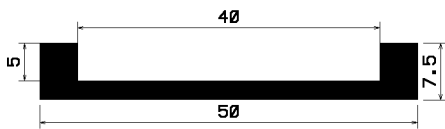

TU1-2152  
EP/s/ 7577

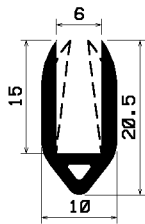

TU1-2154  
NBR/s/ 7588

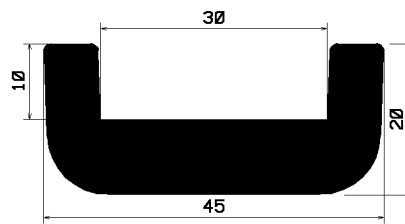

TU1-2158  
EP/s/ 7593

# Vollgummi

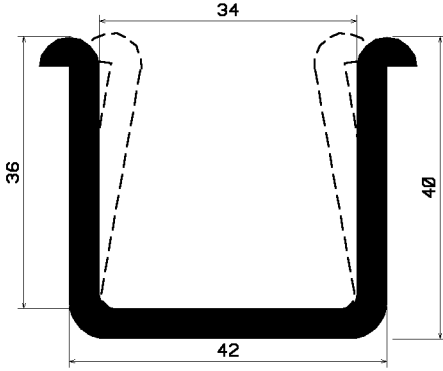

TU1-2164  
EP/s/ 7604

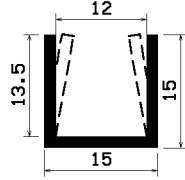

TU1-2167  
Si/l/ 7610

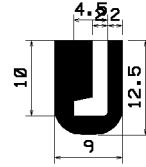

TU1-2191  
EP/s/ 7653

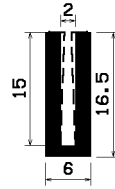

TU1-2192  
Si/w/ 7657

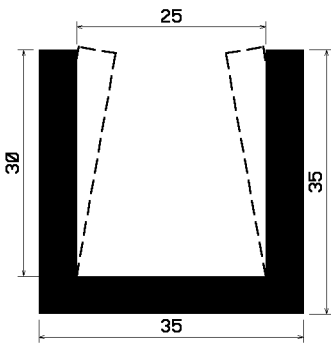

TU1-2198  
EP/s/ 7672

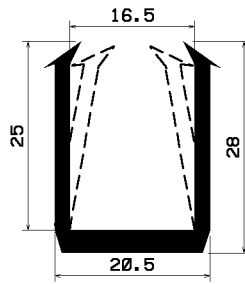

TU1-2212  
EP/s/ 7703

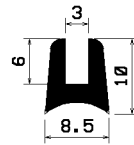

TU1-2220  
CR/s/ 7716

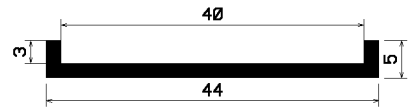

TU1-2225  
EP/s/ 7726

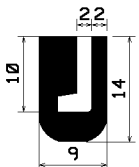

TU1-2226  
EP/s/ 7726

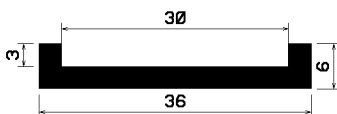

TU1-2235  
EP/s/ 7830

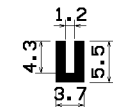

TU1-2237  
EP/s/ 7837

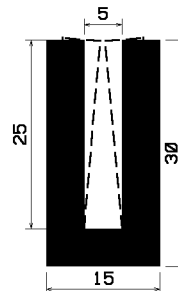

TU1-2252  
EP/s/ 7864

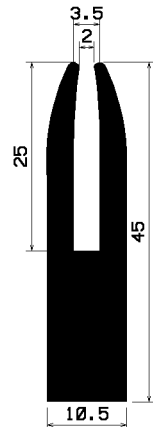

TU1-2262  
EP/w/ 7923



TU1-2287  
Si/l/ 5862

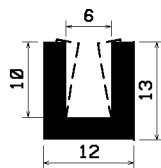

TU1-2301  
Si/l/ 8010

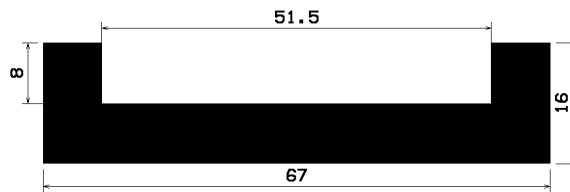

TU1-2316  
Si/l/ 8055

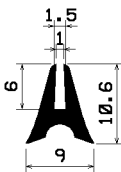

TU1-2335  
EP/s/ 8120

# Vollgummi

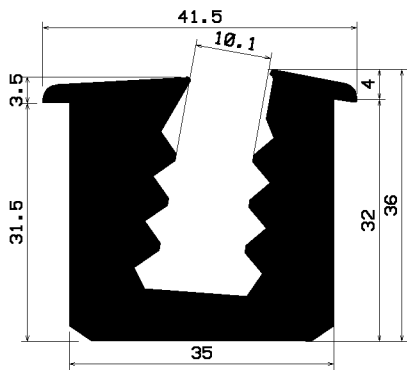

TU1-2349  
EP/s/ 8148

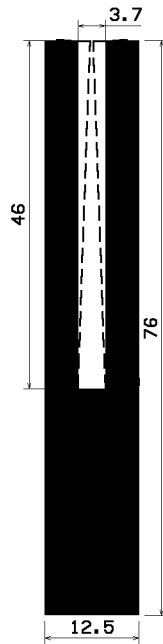

TU1-2350  
EP/s/ 8165

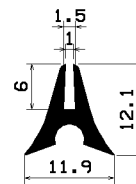

TU1-2363  
EP/s/ xxxx

# Moosgummi

---

## Zeichenerklärung

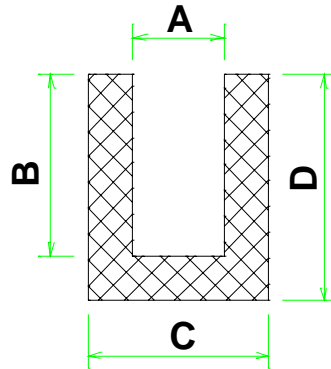

**25999**

bedeutet

*Profil-Nr.*

**EP / s / 9999 / (9998)**

bedeutet

*Qualität / Farbe / Artikel-Nr. / (Artikel-Nr. mit es.sk)*

**es.sk** = einseitig selbstklebend

### Qualität

CR	Neoprene
EP	EPDM
NBR	Perbunan
NK	Naturkautschuk
Si	Silikon
SPS	Silikonschaum
FPM	VITON®
PVC	Weich-PVC

### Farbe

s	schwarz
g	grau
w	weiß
az	anthrazit
bg	beige
br	braun
hg	hellgrau
rb	rotbraun
t	transparent
x	Farbe wählbar

VITON® = Eingetragenes Warenzeichen der Firma DuPont

# Moosgummi

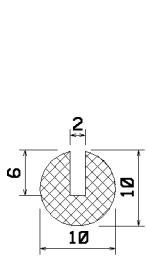

25002

EP/s/ 0260

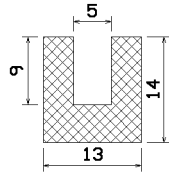

25005

EP/s/ 0263

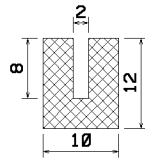

25006

EP/s/ 0264

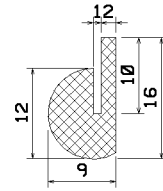

25008

EP/s/ 0269

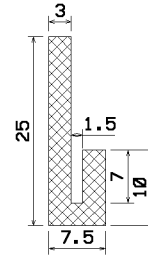

25009

EP/s/ 0270

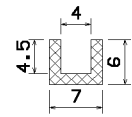

25012

EP/s/ 0273

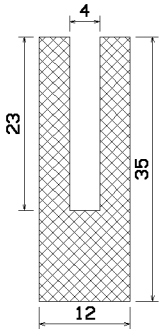

25015

EP/s/ 0276

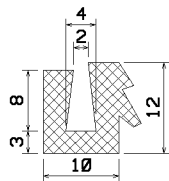

25017

EP/s/ 0277

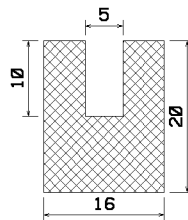

25031

EP/s/ 0290

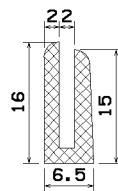

25032

EP/s/ 0291

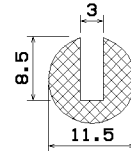

25033

EP/s/ 0292

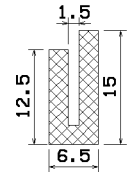

25040

EP/s/ 0299/(1128)

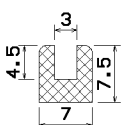

25074

EP/s/ 0329

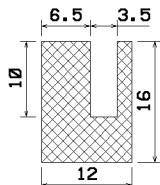

25077

NBR/s/ 0332

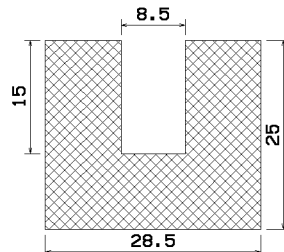

25085

EP/s/ 0340

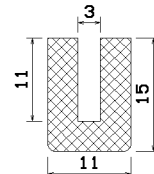

25086

EP/s/ 0341  
EP/g/ 3856

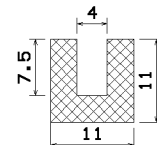

25087

EP/s/ 0342

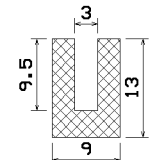

25096

EP/s/ 0350

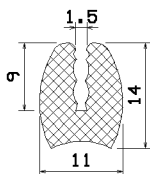

25101

EP/s/ 0354

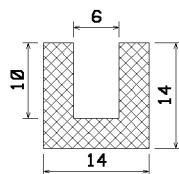

25112

NBR/s/ 0365

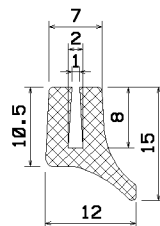

25118

EP/s/ 0371

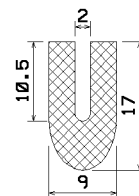

25137

EP/s/ 0390

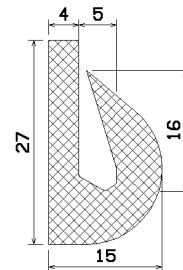

25140

EP/s/ 0393

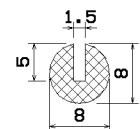

25141

EP/s/ 0394



# Moosgummi

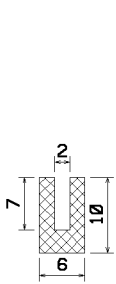

25158

EP/w/ 0738  
EP/s/ 3390

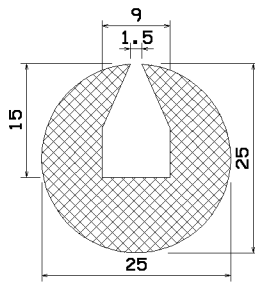

25160

EP/s/ 0740

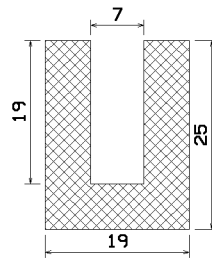

25179

EP/s/ 1374

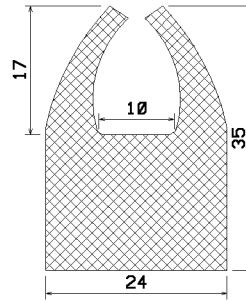

25223

CR/s/ 2862

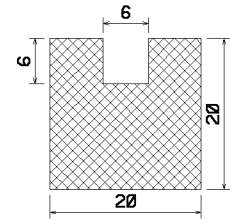

25227

EP/s/ 2928

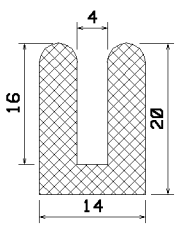

25230

EP/g/ 2947

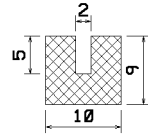

25236

EP/g/ 3004

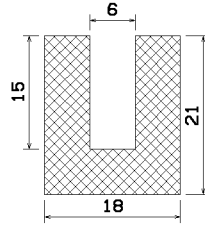

25237

EP/s/ 3010  
EP/g/ 3309

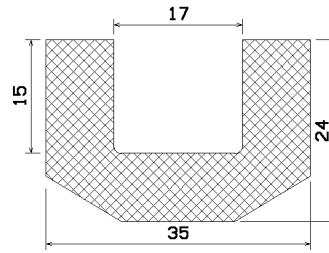

25238

EP/s/ 3005

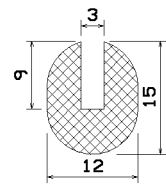

25239

EP/s/ 3014

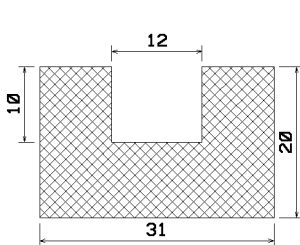

25248

EP/s/ 3048/(4303)

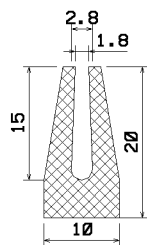

25251

EP/s/ 3043

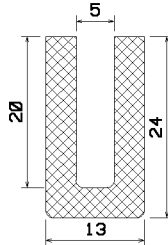

25256

EP/s/ 3044

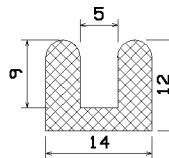

25257

EP/s/ 3055

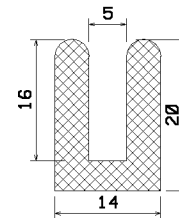

25262

EP/g/ 3089

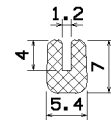

25265

EP/g/ 3136  
EP/s/ 3681

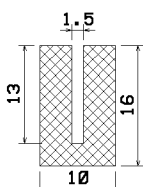

25271

EP/g/ 3183

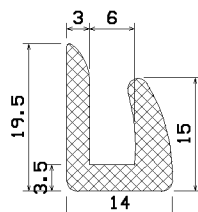

25275

EP/s/ 3237

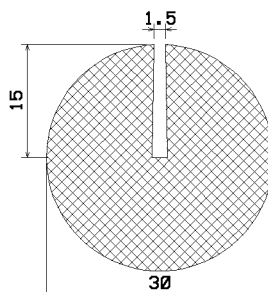

25277

EP/s/ 3263

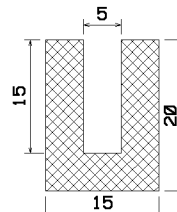

25279

EP/s/ 3283

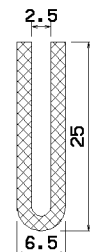

25289

EP/s/ 3341

# Moosgummi

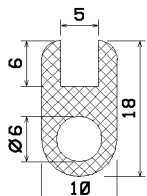

25301  
EP/s/ 3469

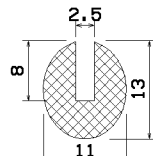

25305  
EP/s/ 3482

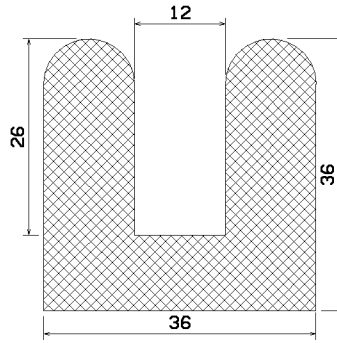

25311  
EP/s/ 3523

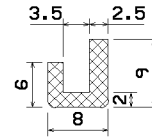

25340  
EP/s/ 3736

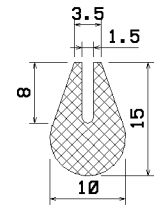

25386  
EP/s/ 4089

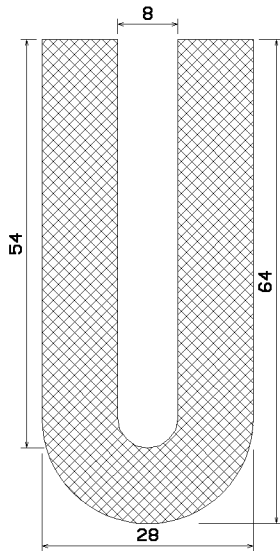

25392  
EP/s/ 4119

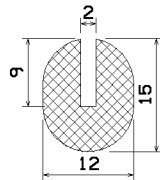

25402  
NBR/s/ 4168

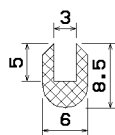

25404  
EP/w/ 4187

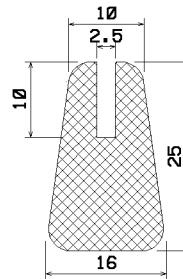

25413  
EP/s/ 1031

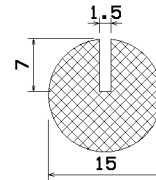

25415  
EP/s/ 1050

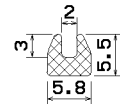

25423  
EP/s/ 1385

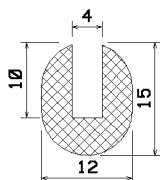

25425  
EP/s/ 1174

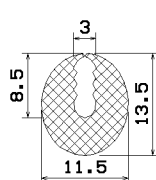

25436  
EP/s/ 1302

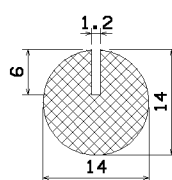

25444  
EP/s/ 1860

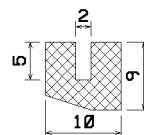

25459  
EP/g/ 3705

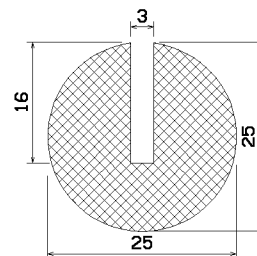

25465  
EP/s/ 4209

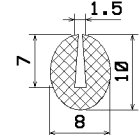

25467  
EP/s/ 4213

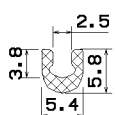

25485  
EP/s/ 4387

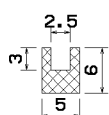

25499  
EP/s/ 5001

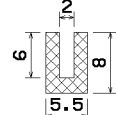

25500  
EP/s/ 5002

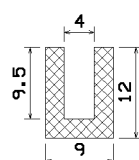

25501  
EP/s/ 5003

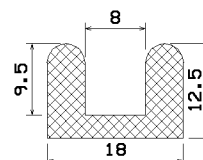

25502  
EP/s/ 5004

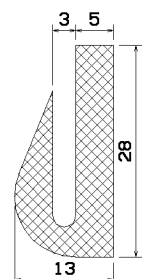

25503  
EP/s/ 5005

# Moosgummi

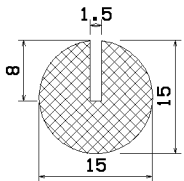

25504  
EP/s/5006

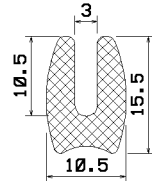

25505  
EP/s/5007

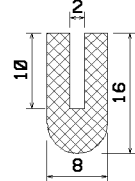

25506  
EP/s/5008

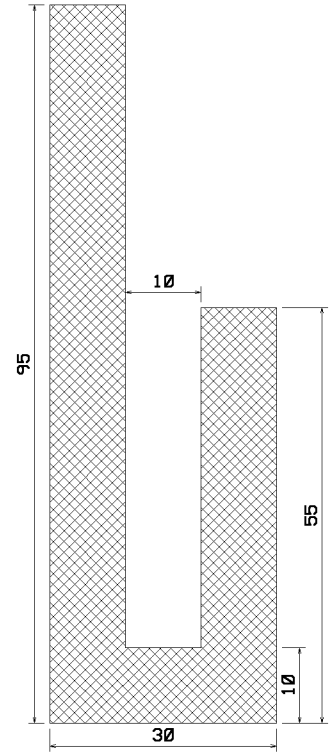

25510  
EP/s/5012

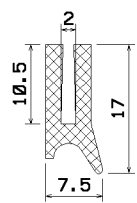

25507  
EP/s/5009

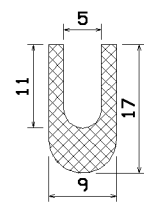

25508  
EP/s/5010

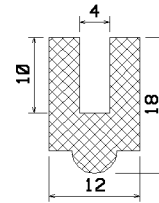

25509  
EP/s/5011

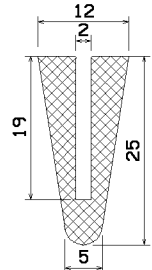

25661  
EP/s/4806

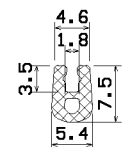

25662  
EP/s/4830

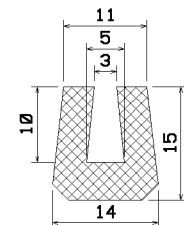

25667  
EP/s/4882

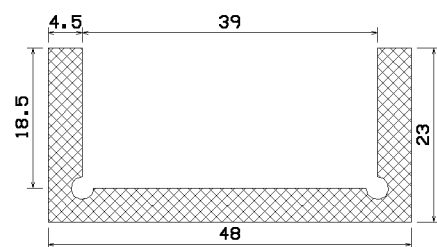

25670  
EP/s/4874

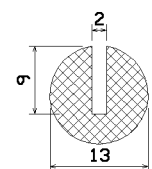

25697  
NBR/s/5460

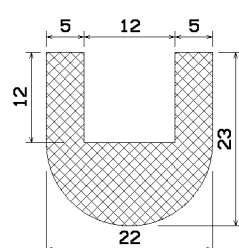

25699  
EP/s/5491

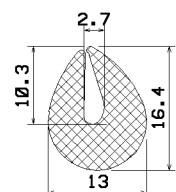

25701  
EP/s/5646

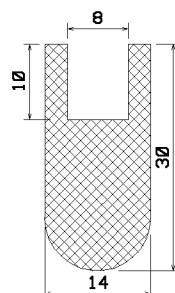

25725  
EP/s/5925

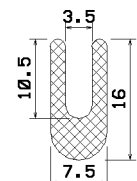

25730  
CR/s/6030

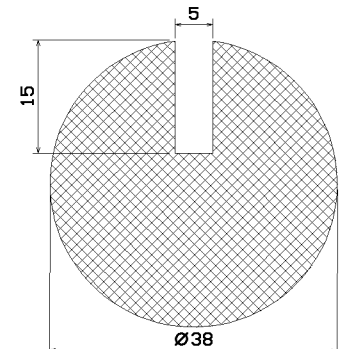

25742  
EP/s/6150

