



**Profile aus Gummi, Moosgummi,
Silikon, Schaumsilikon**

D-64579 Gernsheim

Otto-Hahn-Straße 12

Telefon 0 62 58 / 932250

Telefax 0 62 58 / 4997

e-mail: schild@gummi-plast.de

internet: <http://www.gummi-plast.de>

PROFIL-Liste

Teil 4

Profil-Nr. TU1-1046 bis AN 1504

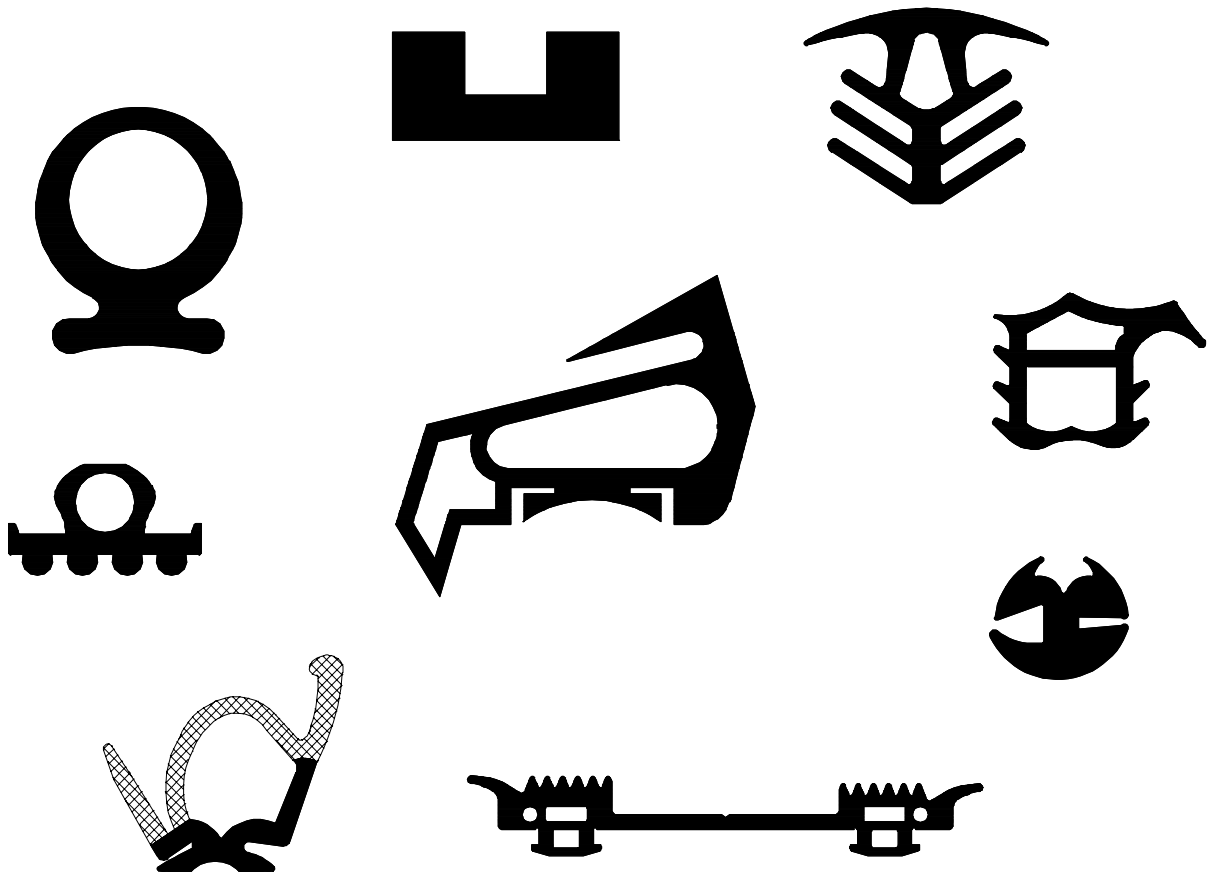

Wichtige Informationen!

Mit dieser Profil-Liste stellen wir Ihnen eine Auswahl aus unserem reichhaltigen Profilsortiment vor. Der Katalog informiert Sie über Art und Größe der Profile, die wir im Rahmen unseres Fertigungsprogramms herstellen.

Wir möchten Sie darauf hinweisen, dass bei einigen Profilen Kundenschutz besteht.

Natürlich fertigen wir auch Ihre Profile aus Gummi, Weich-PVC, Moosgummi, Silikon und Silikonschaum nach Zeichnung oder Muster.

Die Abkürzungen vor den Profil-Nummern bedeuten:

AF	= Allgemeine Fensterdichtungs-Profile
AN	= Anschlag-Profil
AU	= Auflage-Profile
F	= Fassaden-Profile
FA	= Fugenabdeck-Profile
FN	= Fahnen- (Noten-) Profile
FR	= Füller-Profile
FT	= Formteil
FU	= Fenster-U-Profile
GIR	= Gummi-Rundschnüre
GIV	= Gummivierkant-Profile
H	= H-Profile
HF	= Holzfenster-Profile
HR	= Halbrund-Profile
K	= Kühlschranks-Profile
KL	= Klemm-Profile
KS	= Keil- und Steck-Profile
MD	= Mitteldichtungs-Profile
RI	= Riefen-Profile
RT	= Rolltor- und Fingerschutz-Profile
S	= Sonstige Profile
SC	= Schlauch-Profile
SE	= Schellen-Profile
SL	= Siebleisten-Profile
T	= T-Profile
TR	= Trapez-Profile
TU1-	= Technische-U-Profile
VP	= Verglasungs-Profile
WI	= Winkel-Profile
Z1-	= Zargen-Profile

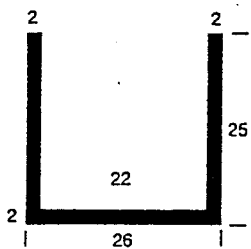

TU1-1046

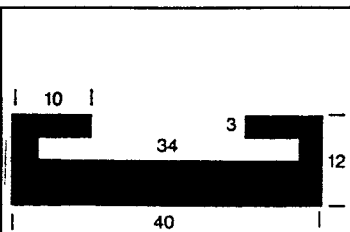

SE1047

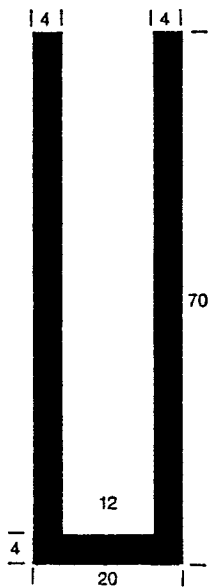

TU1-1048

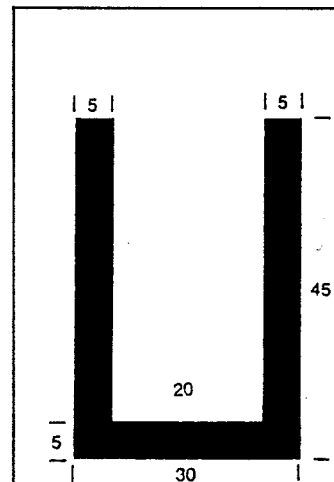

TU1-1049

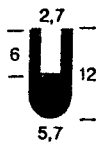

TU1-1050



TU1-1051

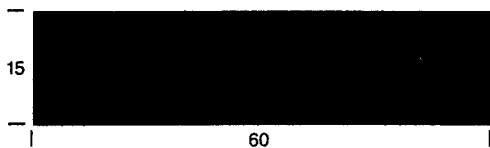

GIV1052

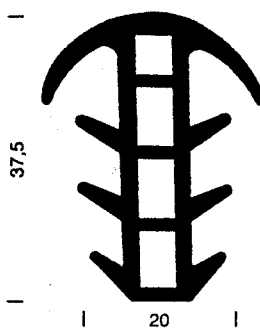

FA1053

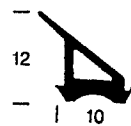

S1054



S1055



S1056



S1057

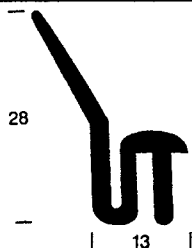

S1058

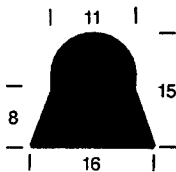

S1059



S1060

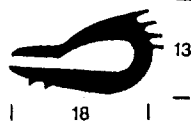

S1061



S1062

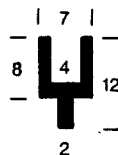

S1063

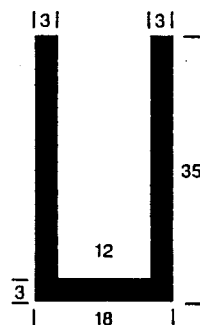

TU1-1064

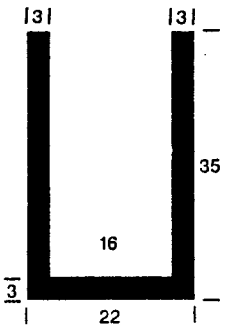

TU1-1065

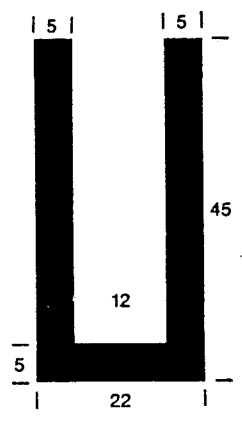

TU1-1066

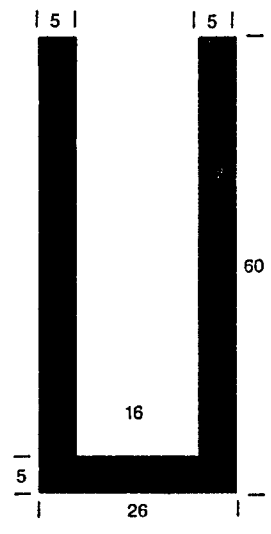

TU1-1067

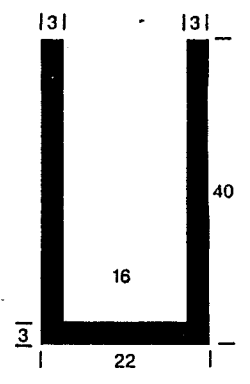

TU1-1068

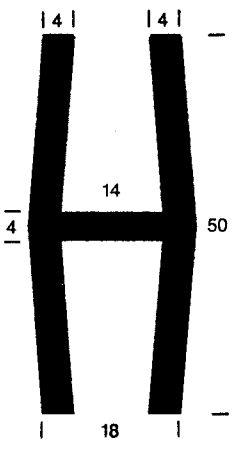

H1069

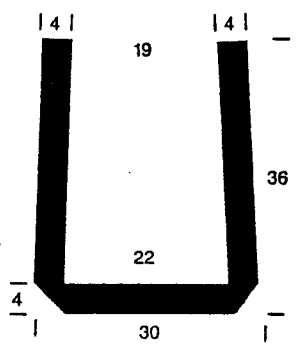

TU1-1070

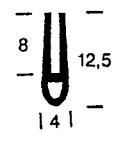

TU1-1071

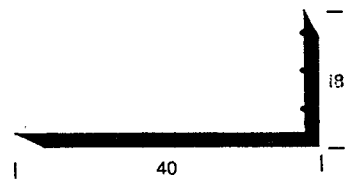

WI1072

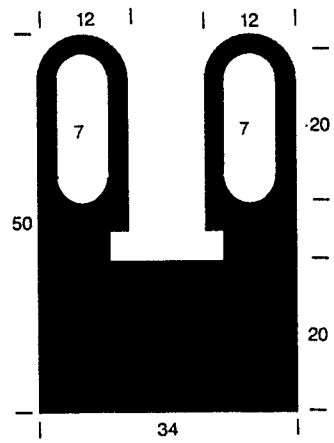

S1073

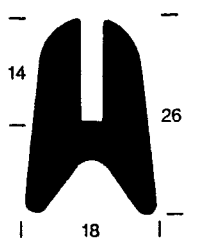

TU1-1074

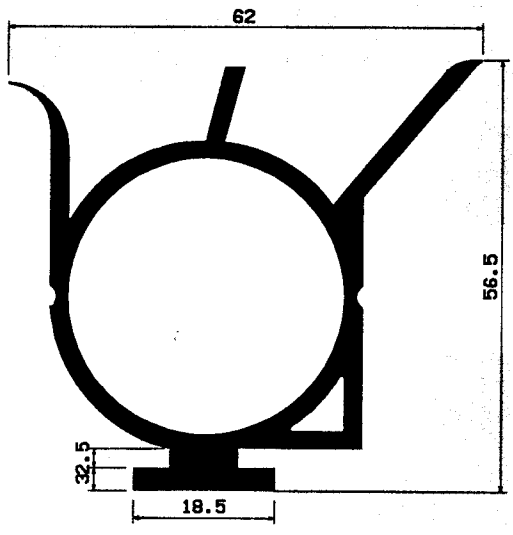

RT1077



AN1076

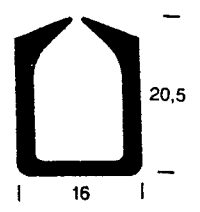

TU1-1075



TU1-1078

<p>S1079</p>	<p>TU1-1080</p>	<p>FA1081</p>	<p>TU1-1082</p>
<p>TU1-1083</p>	<p>S1084</p>	<p>T1085</p>	
	<p>S1087</p>		
<p>RT1086</p>	<p>RT1088</p>		
<p>TU1-1089</p>	<p>TU1-1090</p>	<p>S1092</p>	<p>H1091</p>
<p>TU1-1089</p>	<p>H1091</p>	<p>KL1093</p>	<p>KL1094</p>

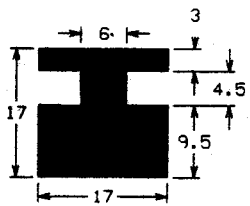

S1095

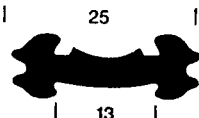

S1096

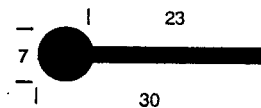

FN1097

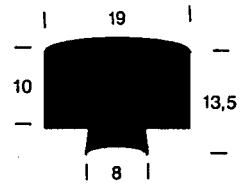

S1098

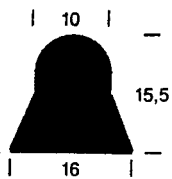

S1099

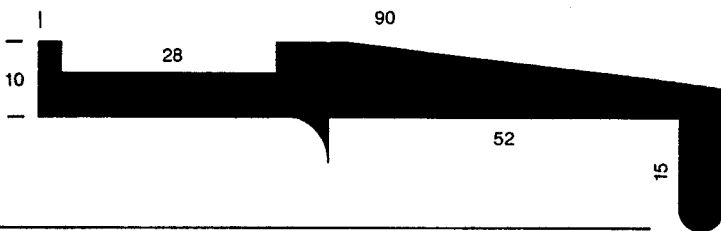

S1100

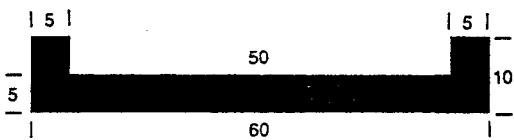

TU1-1101

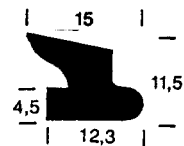

S1103

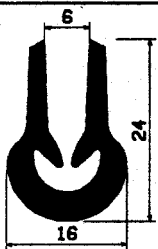

S1104



VP1105

RT1102



AN1106



AN1106/1

FT1107

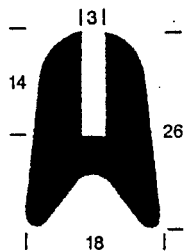

TU1-1109

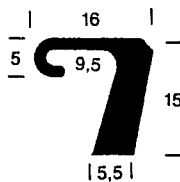



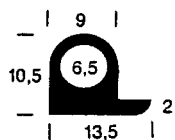



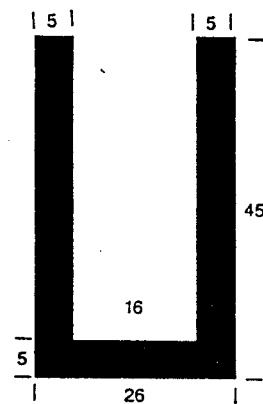

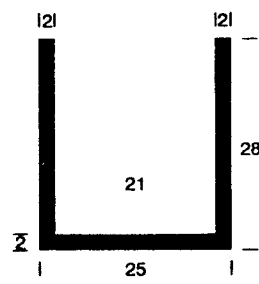

S1110



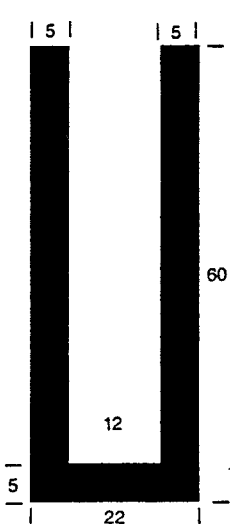
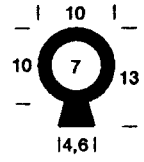

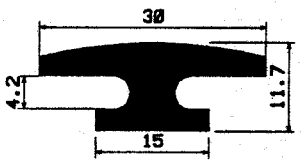
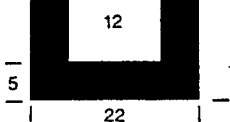

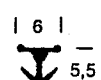
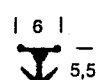
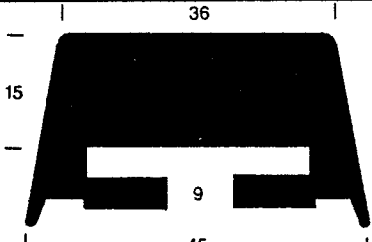

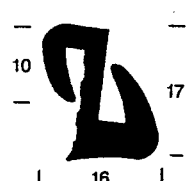
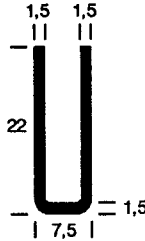
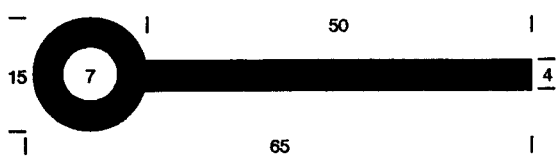
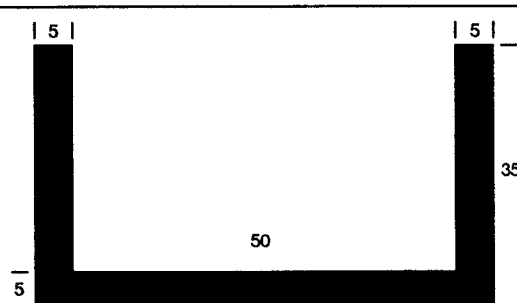

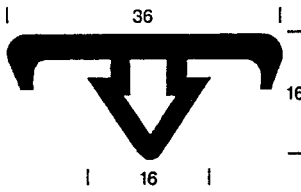
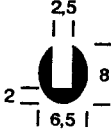
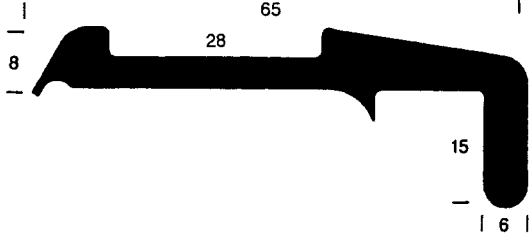
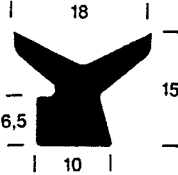

S1108

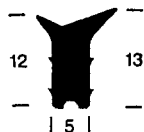
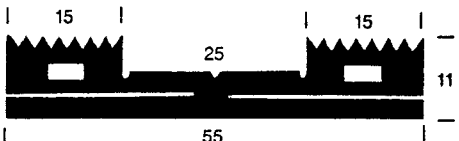
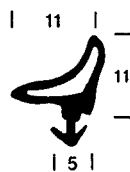
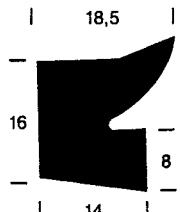
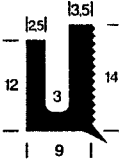
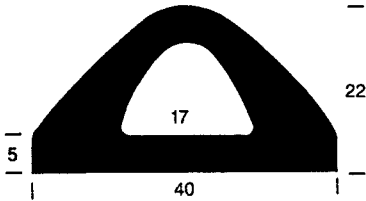

TU1-1111

			
<p>S1112</p>	<p>TU1-1113</p>	<p>S1114</p>	<p>MD1115</p>
			
<p>AN1116</p>	<p>TU1-1117</p>	<p>FT1118</p>	<p>SC1119</p>
			
<p>H1120</p>	<p>TU1-1121</p>	<p>MD1122</p>	<p>AN1123</p>
			
<p>AN1123</p>	<p>S1124</p>	<p>AN1125</p>	
			
<p>VP1126</p>	<p>S1127</p>	<p>TU1-1128</p>	
			
<p>FN1129</p>	<p>TU1-1130</p>		

			
<p>AU1131</p>	<p>TU1-1132</p>	<p>S1133</p>	
			
<p>S1134</p>	<p>VP1135</p>	<p>KS1136</p>	<p>KS1136/1</p>
			
<p>KS1136/2</p>	<p>S1137</p>	<p>S1138</p>	<p>FT1139</p>
			
<p>F1140</p>		<p>AN1141</p>	<p>S1142</p>
			
<p>TU1-1143</p>	<p>S1144</p>		
			
<p>KS1145</p>	<p>KS1146</p>	<p>KS1146/2</p>	<p>FT1147</p>

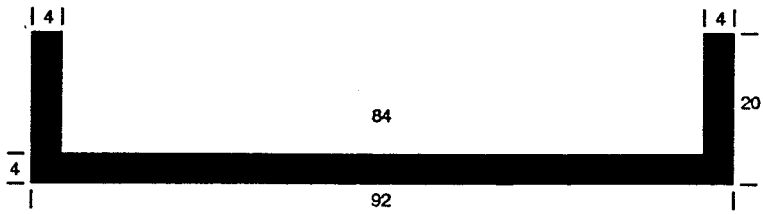

TU1-1148

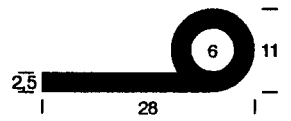

FN1150

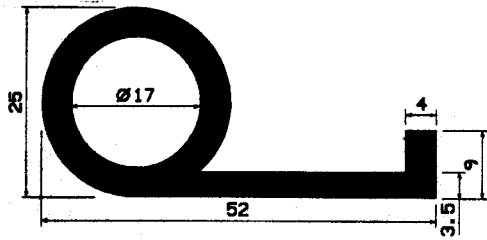

FN1149

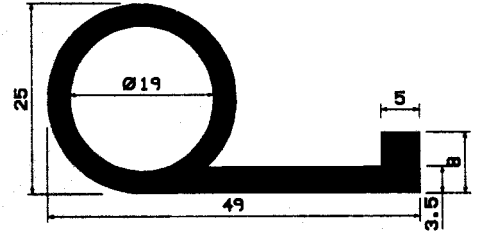

FN1151

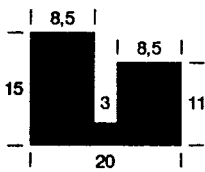

TU1-1152

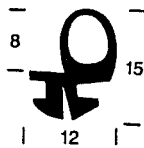

S1153

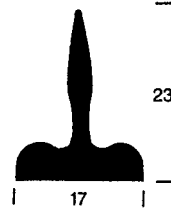

S1154



AF1155



AF1156

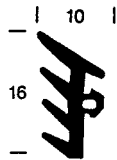

VP1157

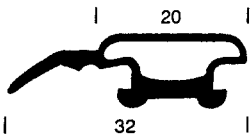

S1159

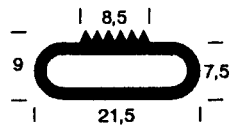

S1160

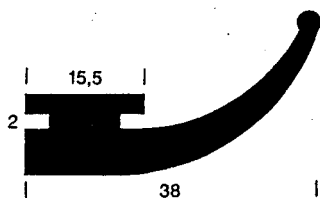

S1161

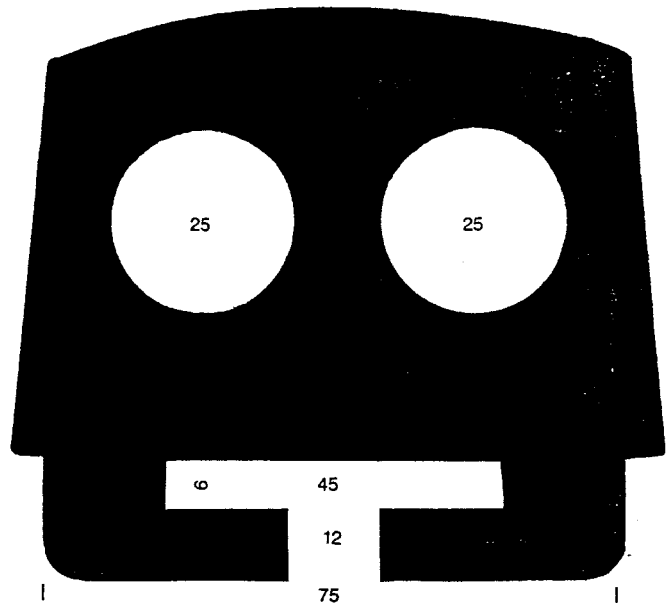

S1158

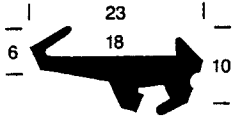

S1162

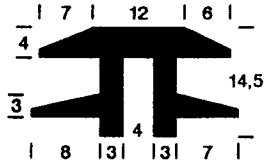

S1163



KS1165

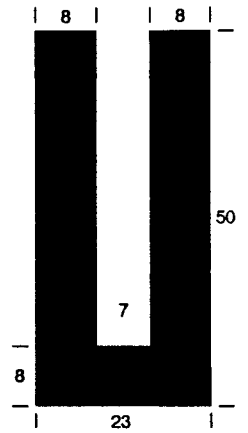

TU1-1164



AN1166

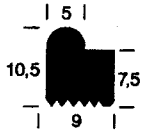

S1167



FN1168

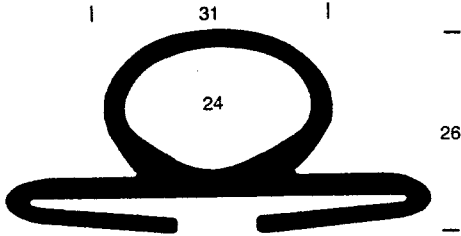

S1169



S1170

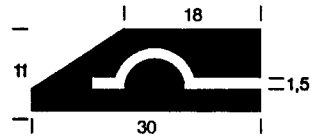

S1171

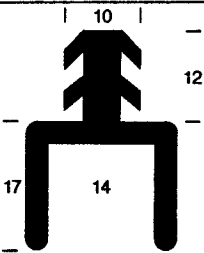

S1172



S1173

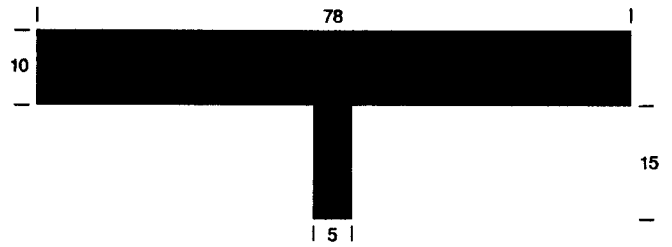

T1174



AF1175



MD1176

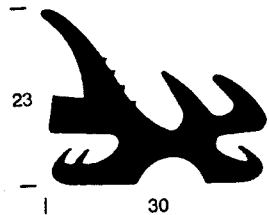

S1177

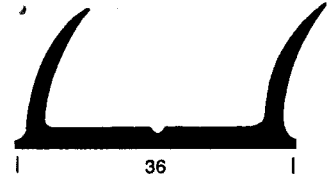

S1178

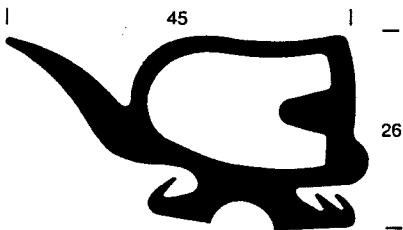

S1179

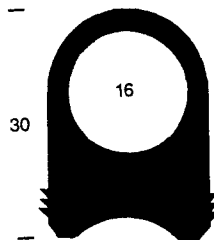

S1180



TU1-1181

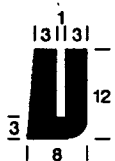

TU1-1182

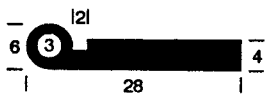

FN1183

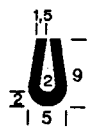

TU1-1184



AN1185



AN1185/1



WI1186

FT1187

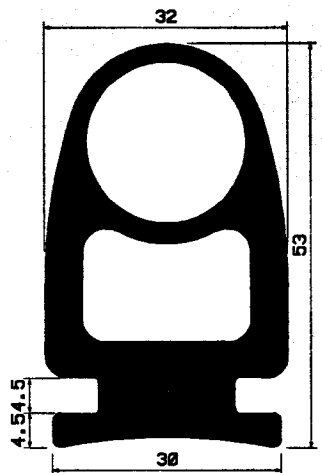

RT1188

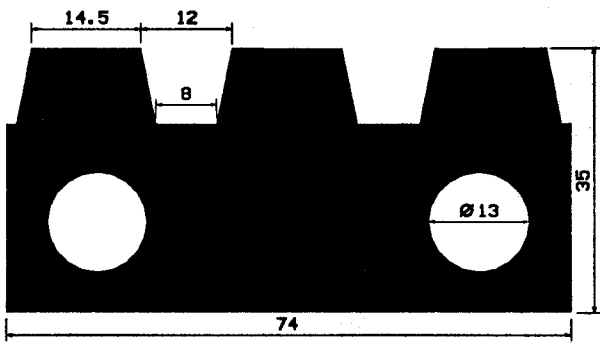

S1189

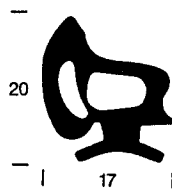

S1190

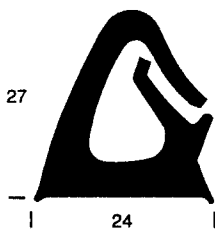

S1191

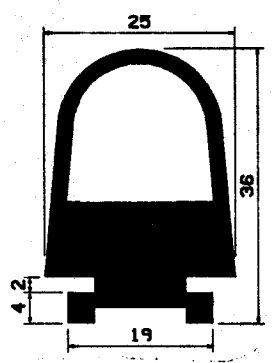

RT1192

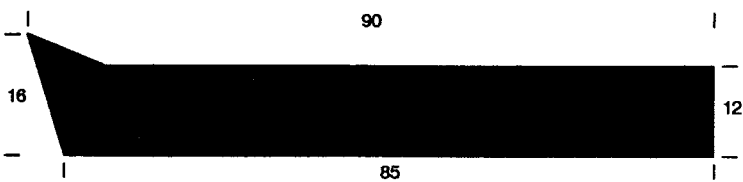

S1193

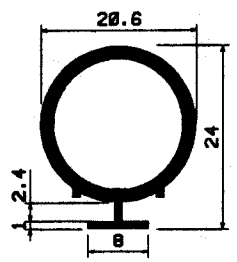

RT1194



MD1195



S1196

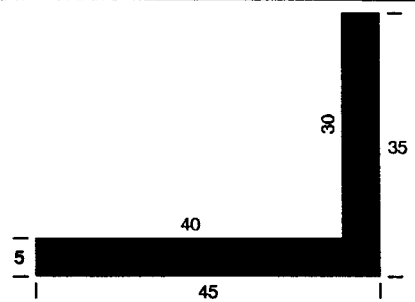

WI1197



S1198



S1199



S1200

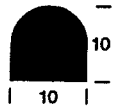

HR1201

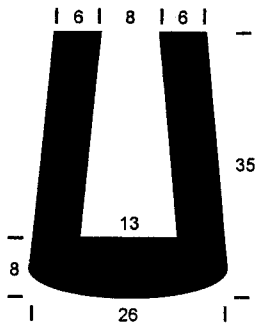

TU1-1202



S1203

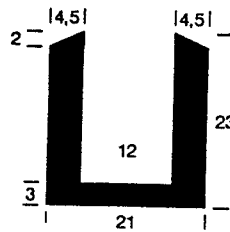

TU1-1204

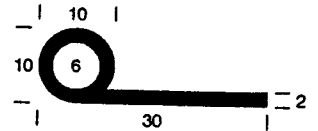

FN1205

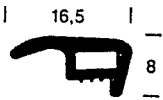

S1206



HR1208

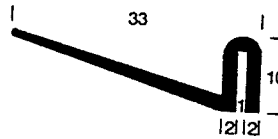

S1209

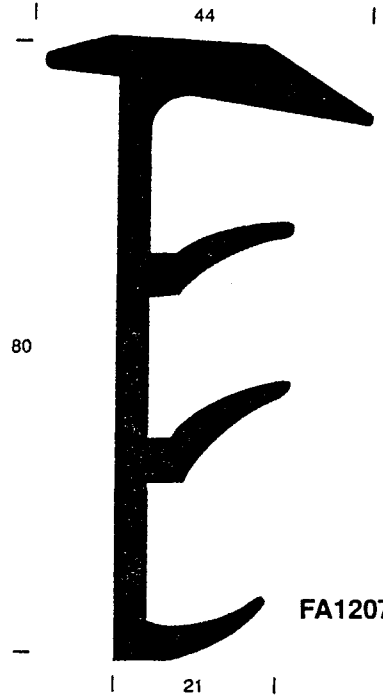

FA1207

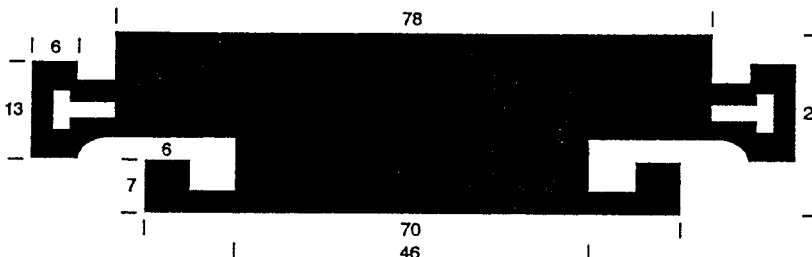

S1212



S1210



S1211



S1213

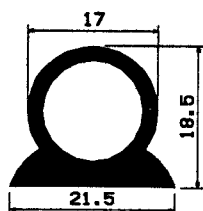

RT1214

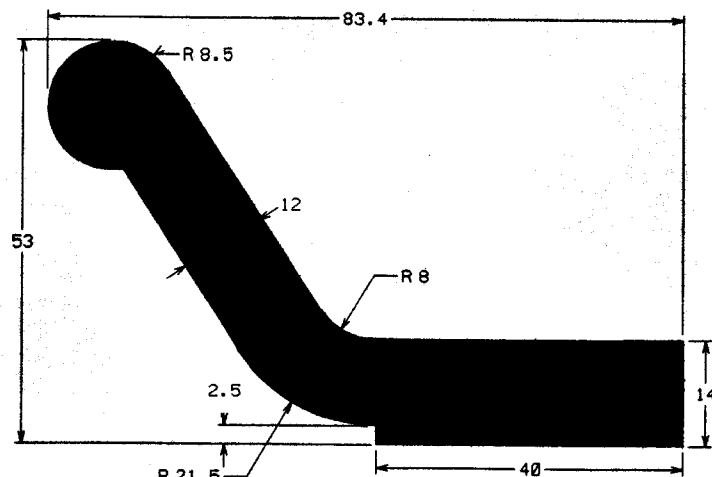

S1215

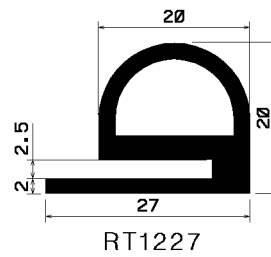
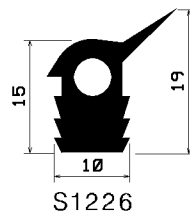
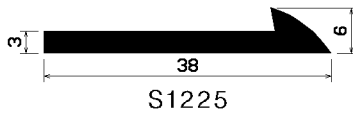
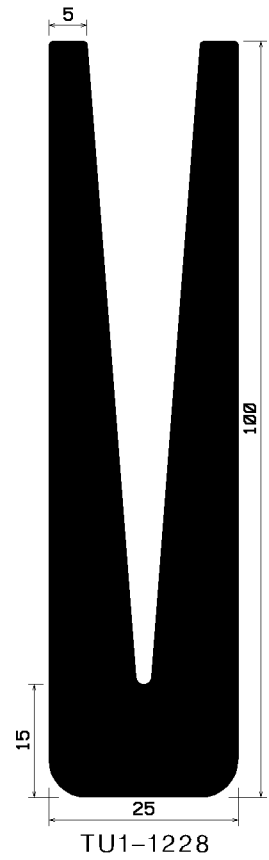
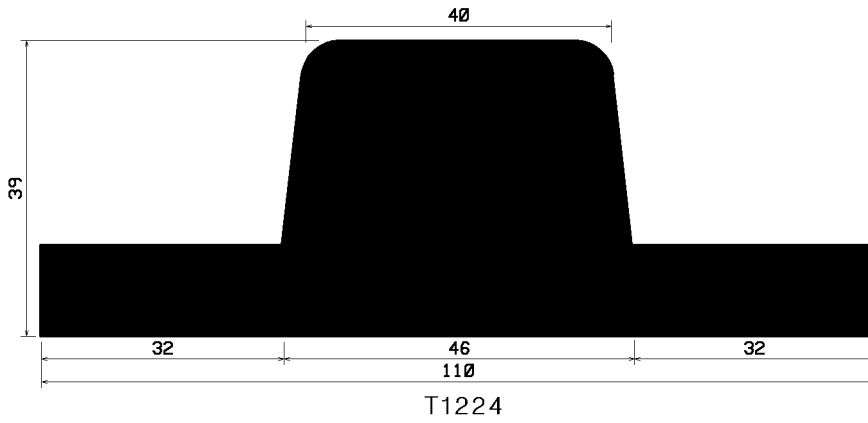
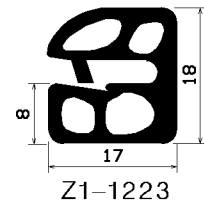
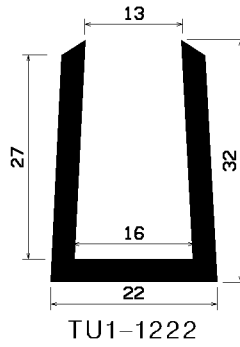
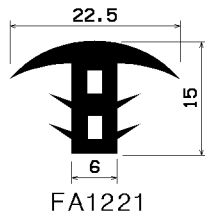
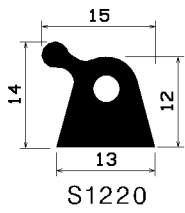
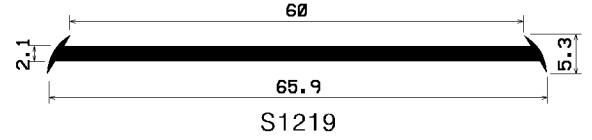
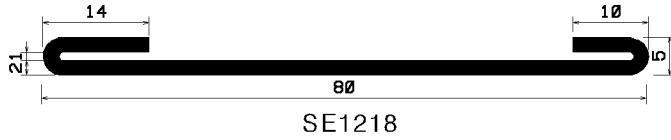
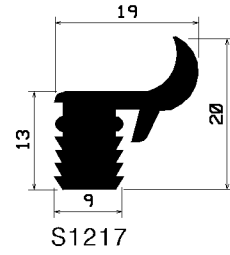
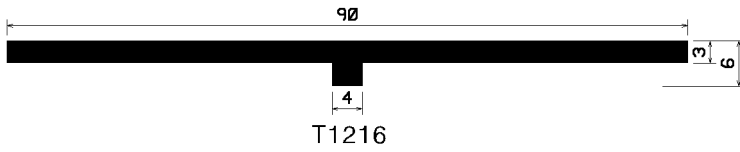

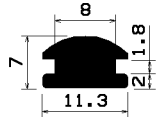

S1229

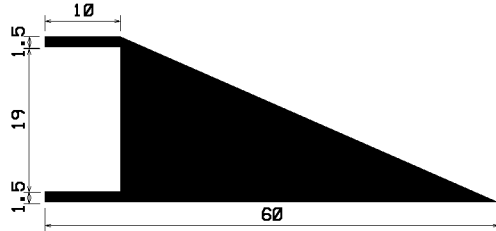

S1230

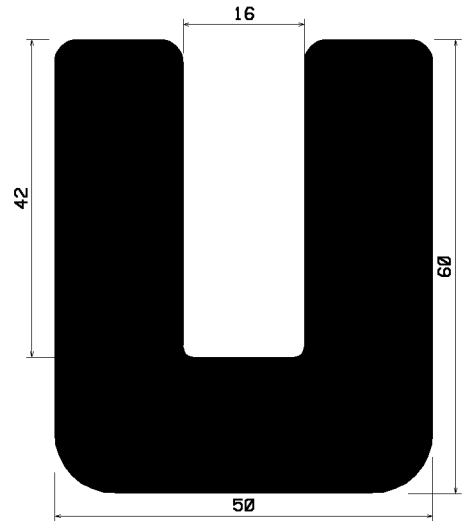

TU1-1231

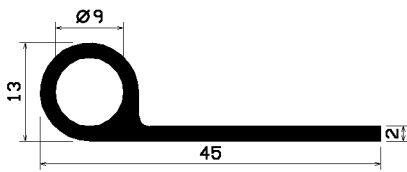

FN1232

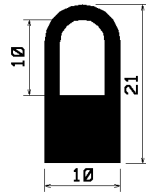

HR1233

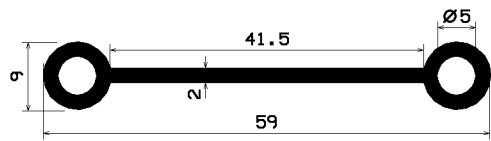

S1234

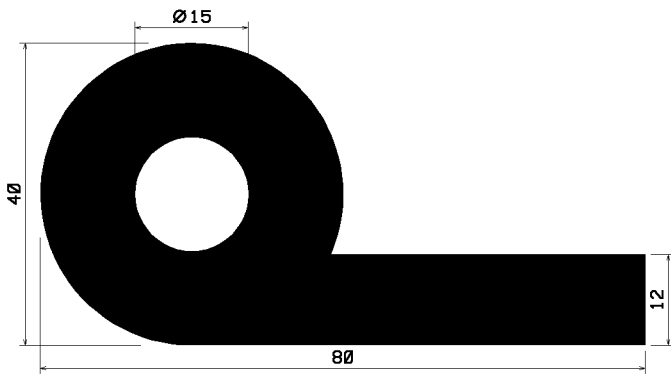

FN1235

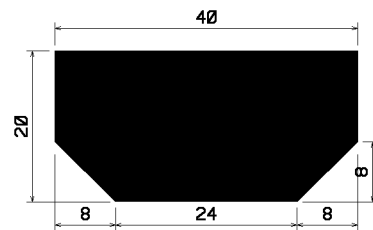

S1236

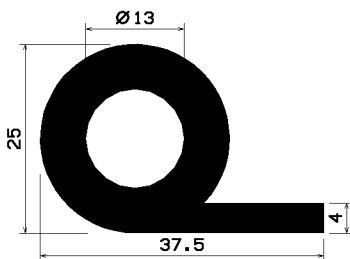

FN1237

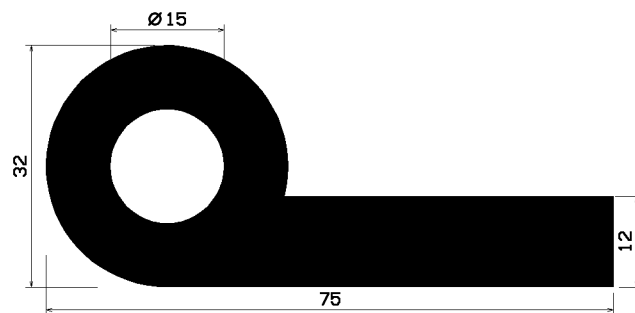

FN1238

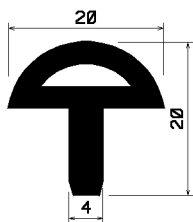

FA1239

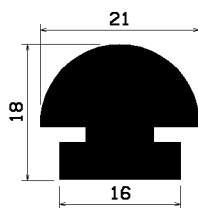

S1240

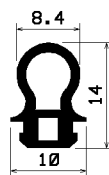

S1241

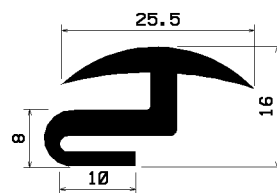

S1242

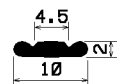

S1243

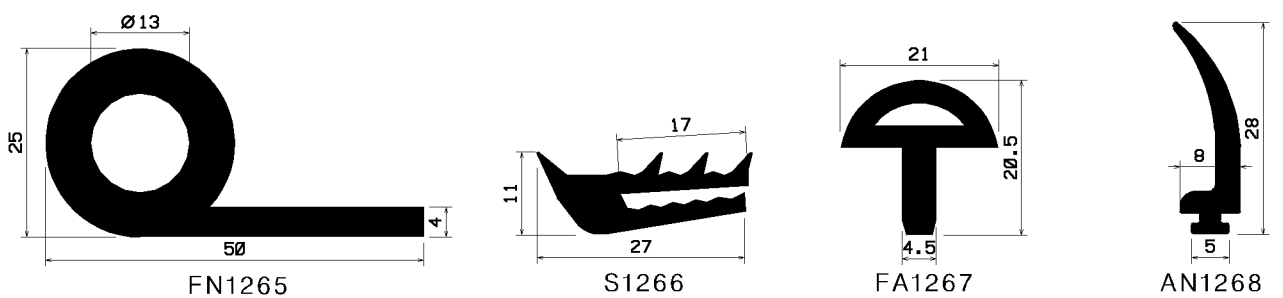
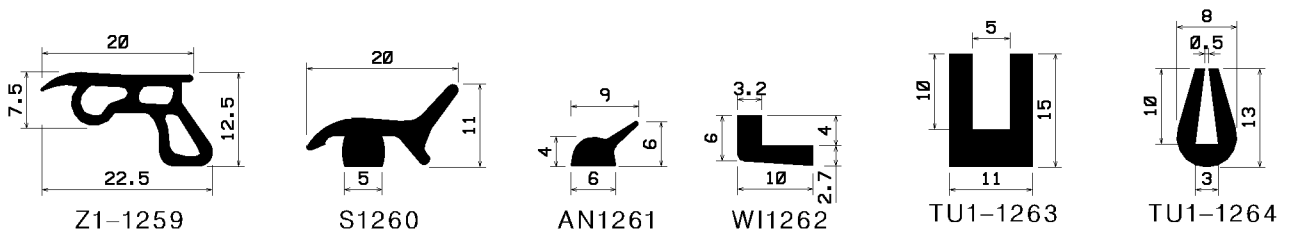
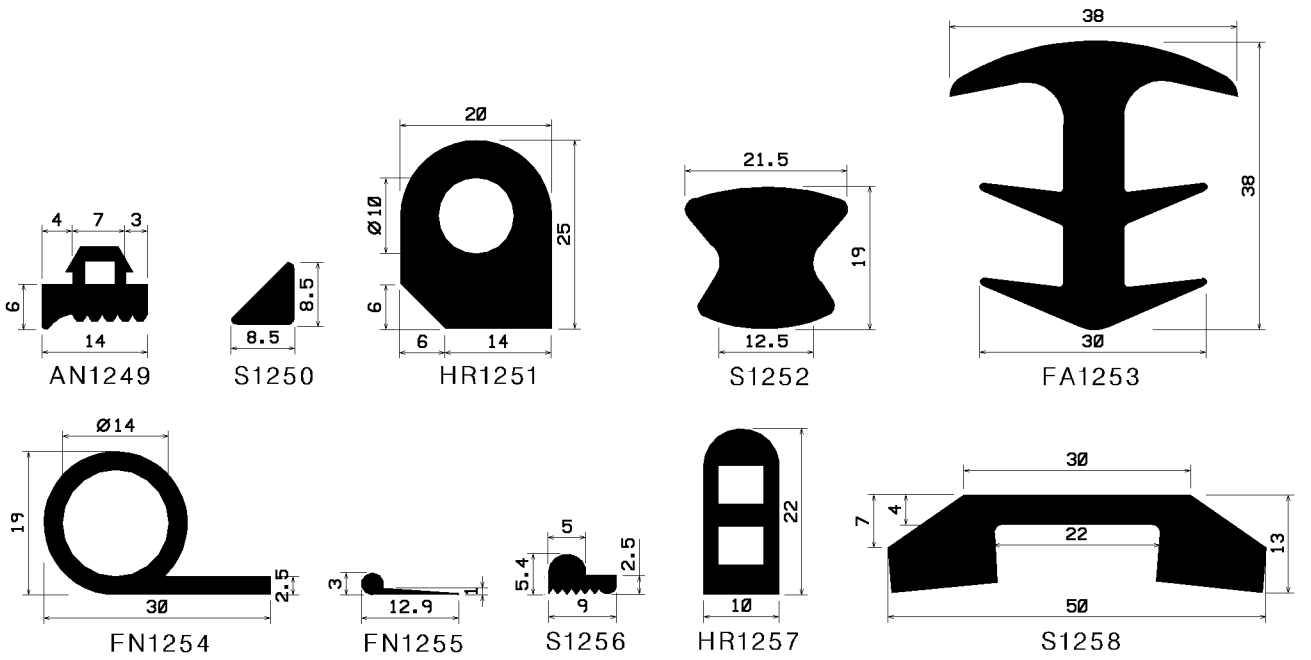
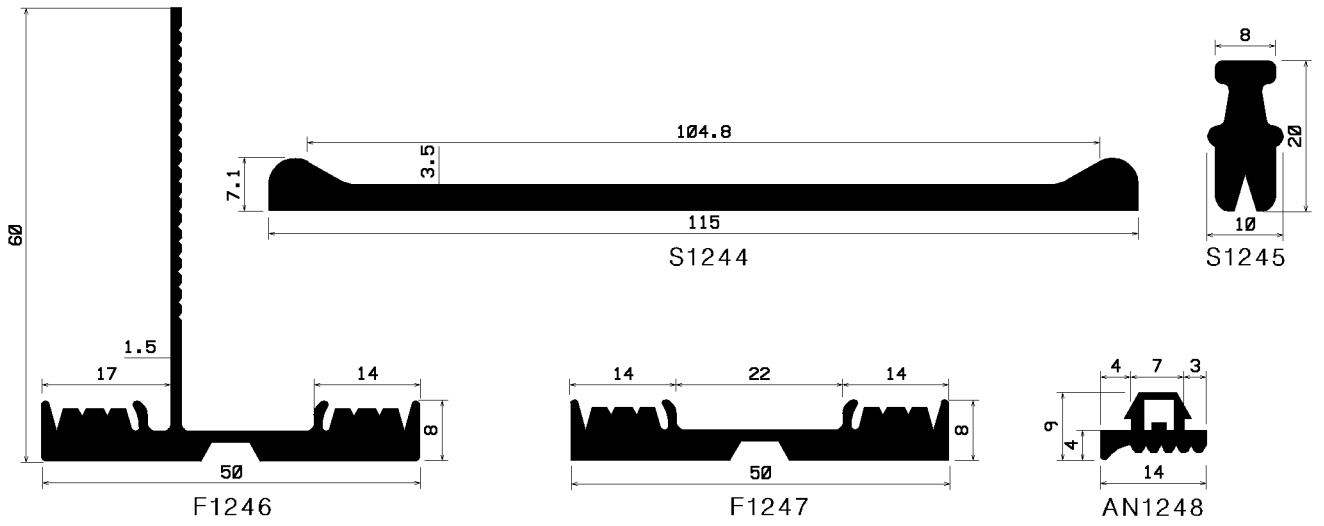

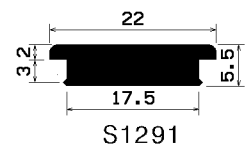
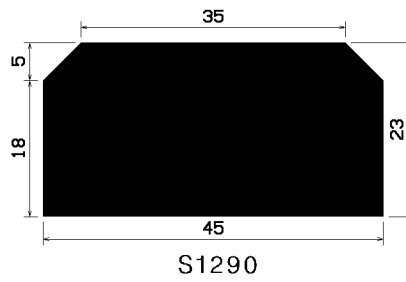
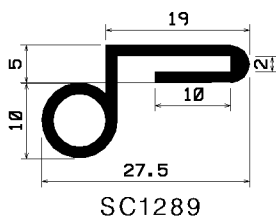
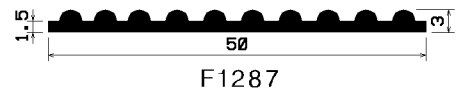
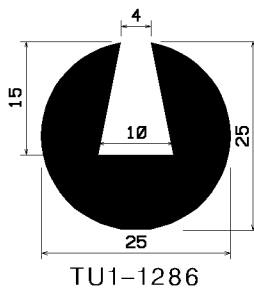
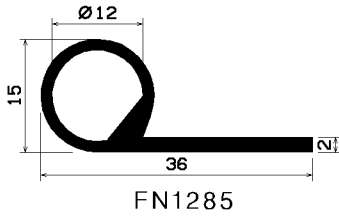
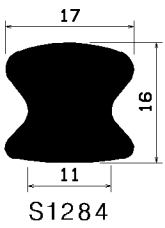
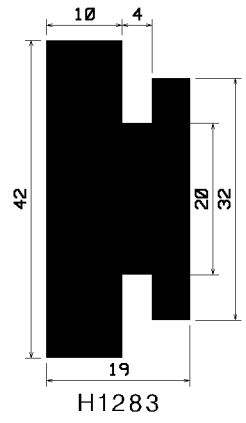
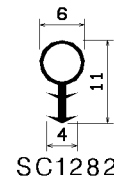
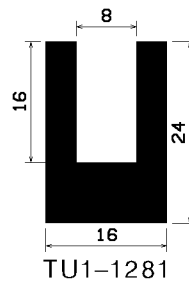
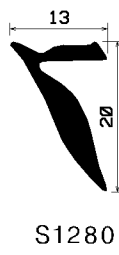
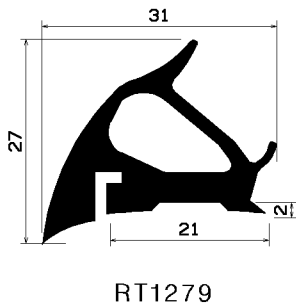
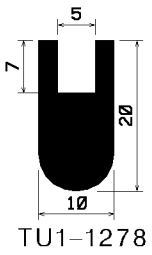
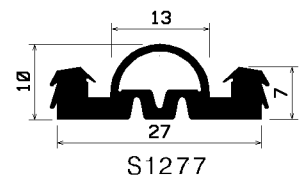
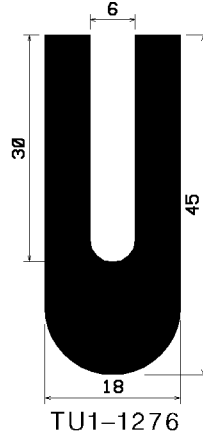
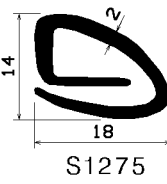
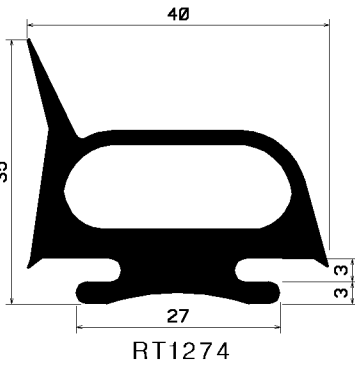
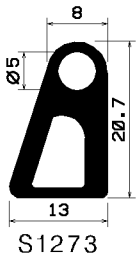
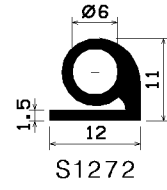
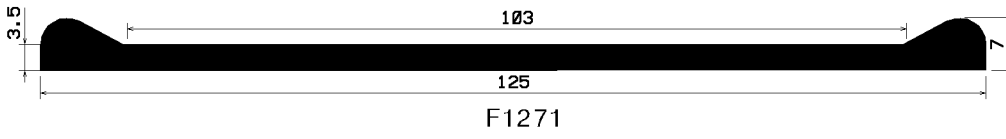
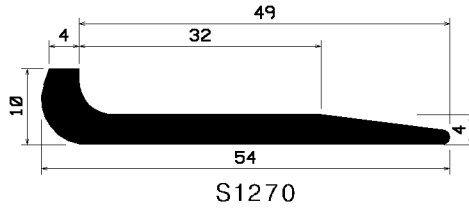
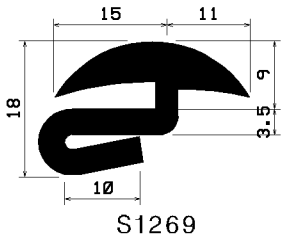

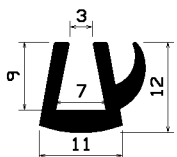

TU1-1292

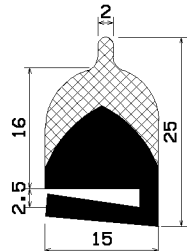

S1293

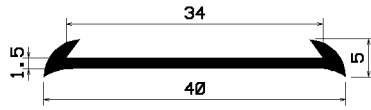

F1294

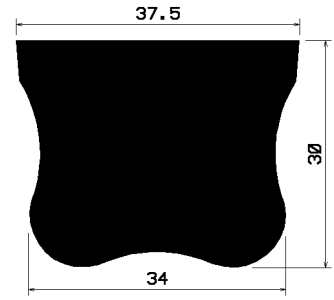

S1295

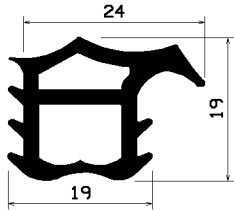

Z1-1296

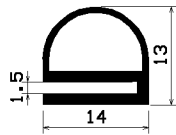

RT1297

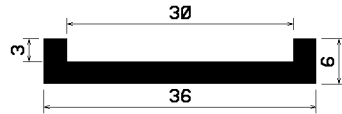

TU1-1298

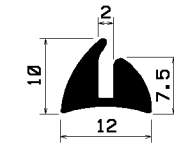

S1299

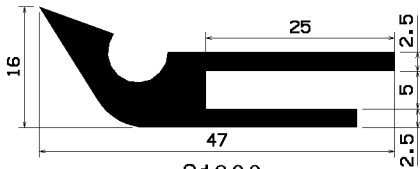

S1300

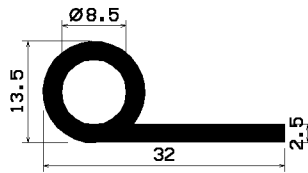

FN1301

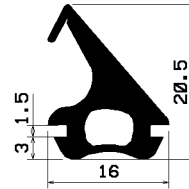

MD1302

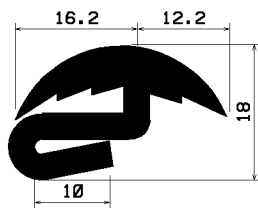

S1303

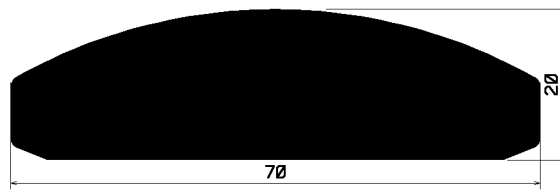

S1304

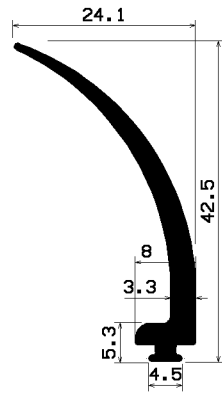

AN1305

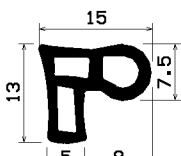

Z1-1306

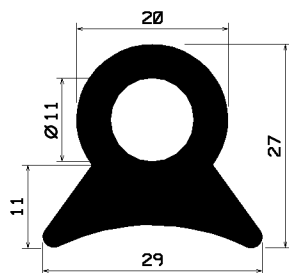

S1307



HR1308

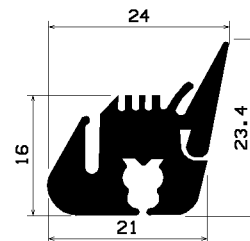

KL1309

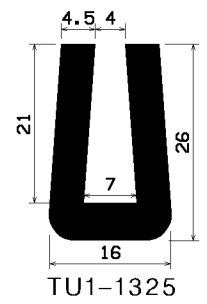
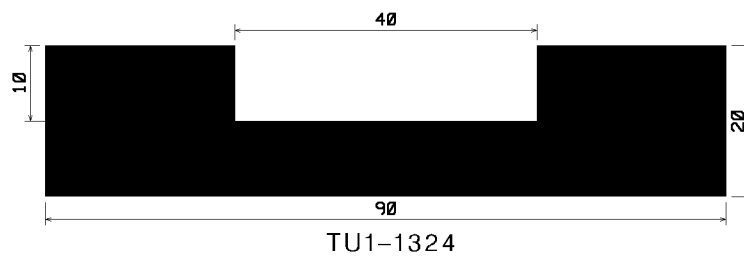
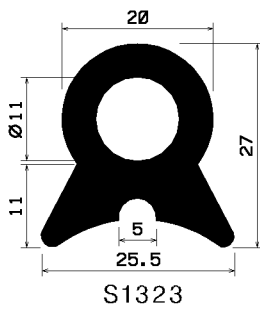
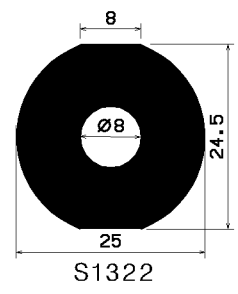
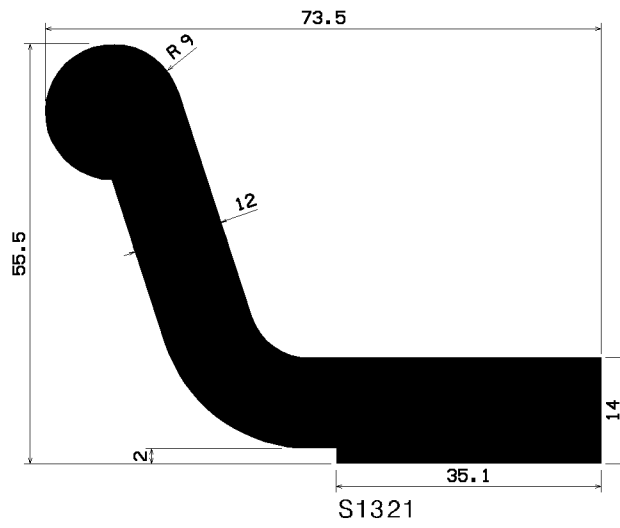
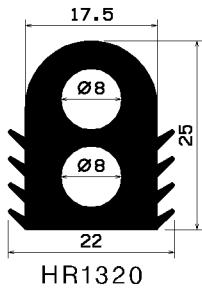
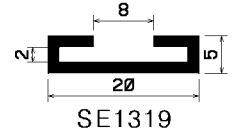
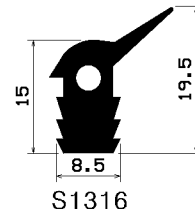
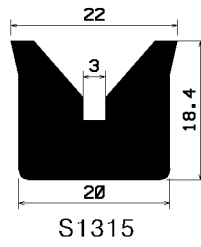
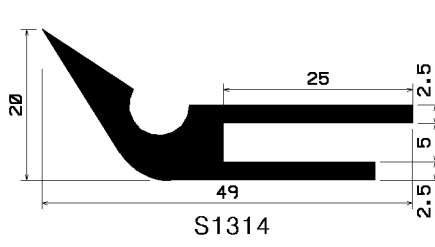
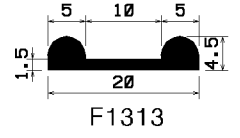
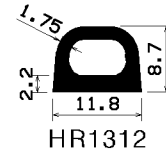
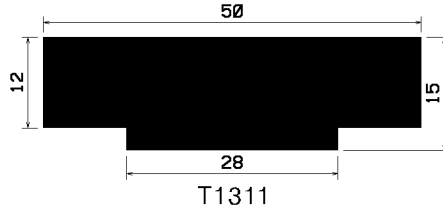
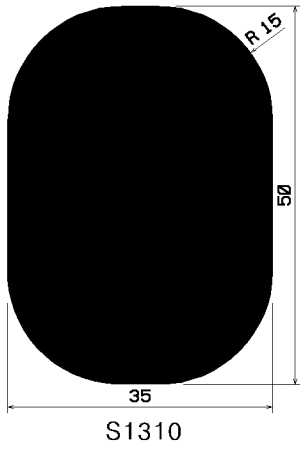

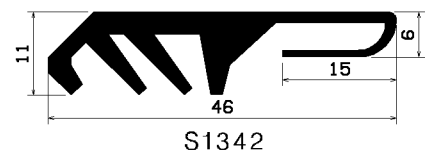
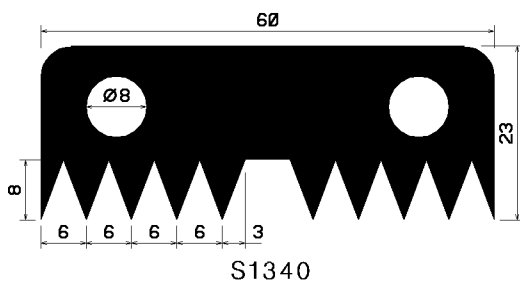
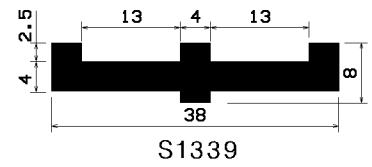
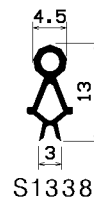
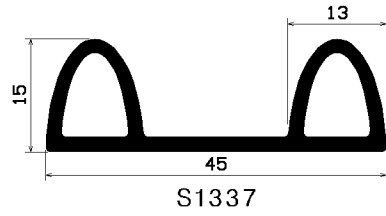
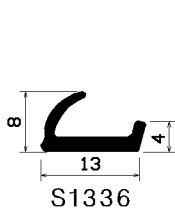
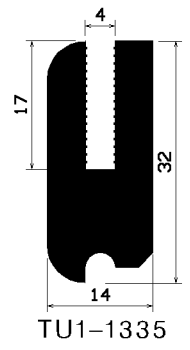
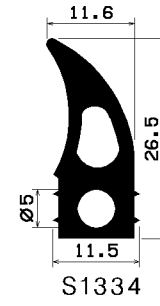
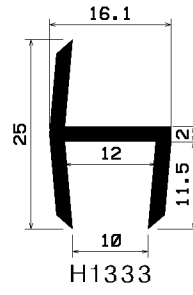
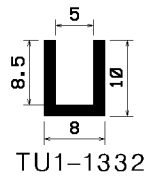
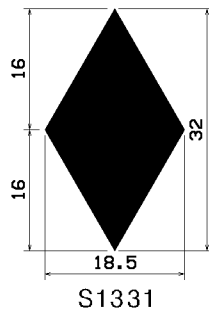
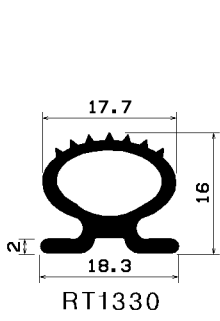
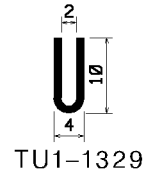
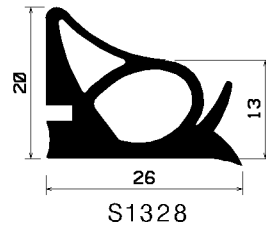
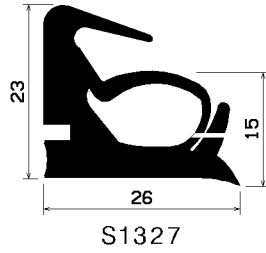
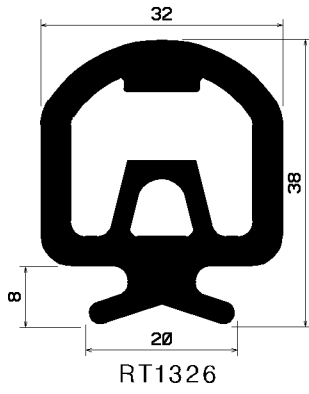

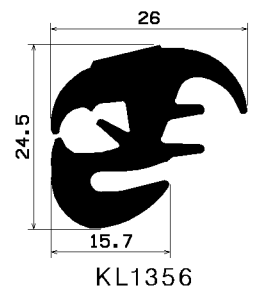
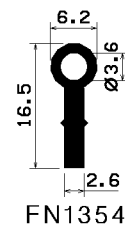
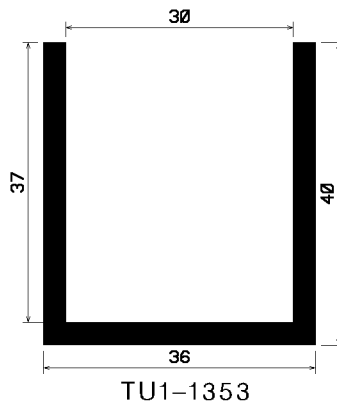
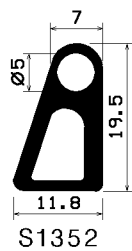
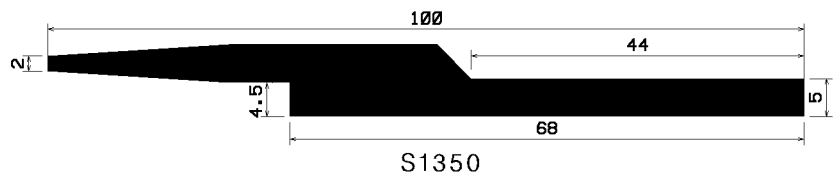
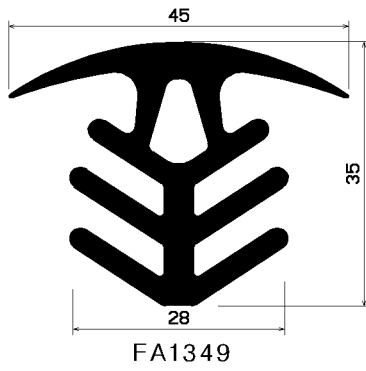
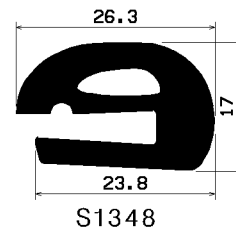
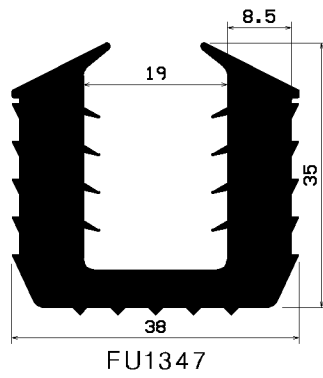
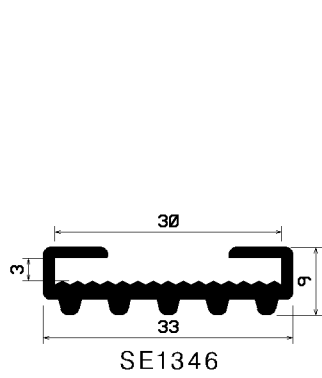
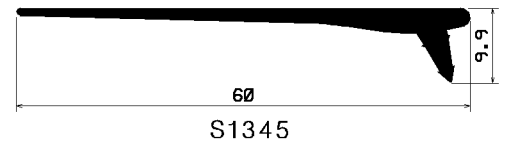
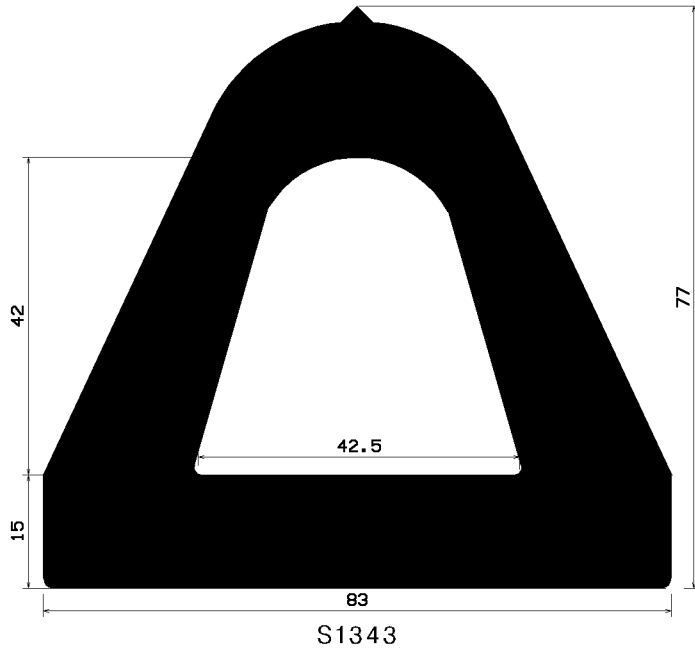

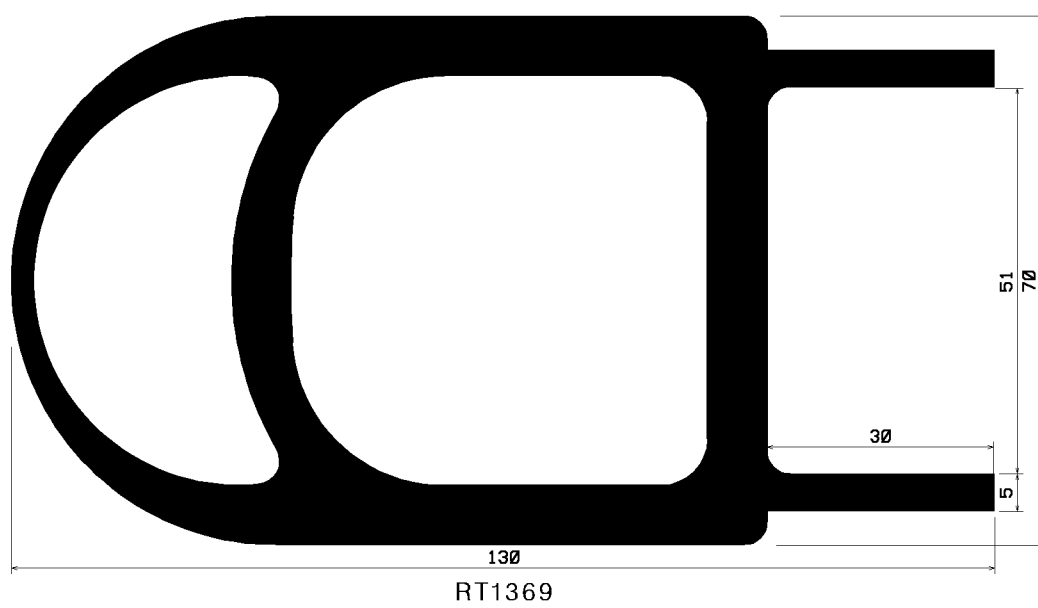
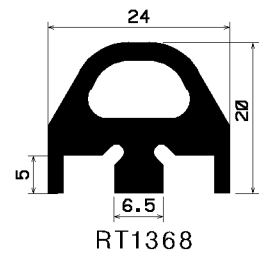
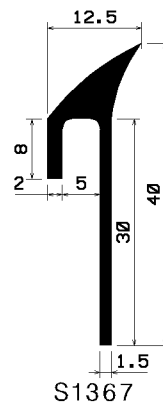
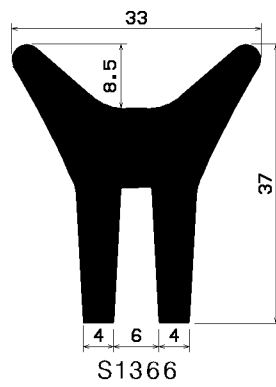
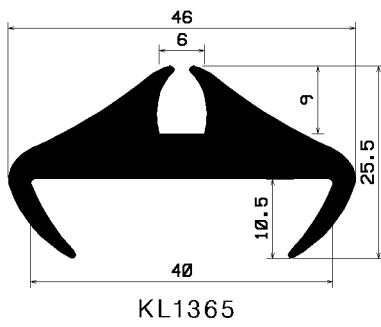
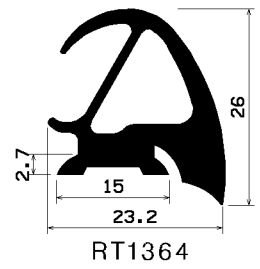
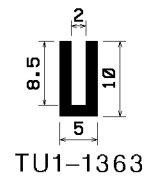
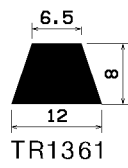
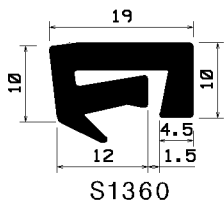
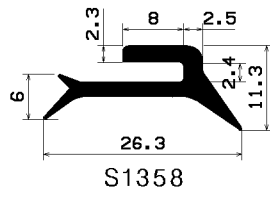
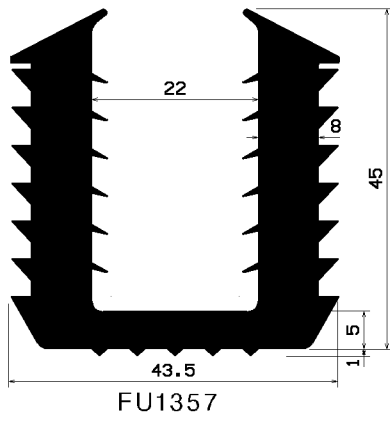

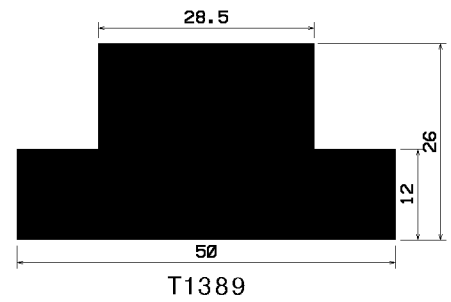
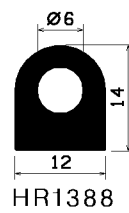
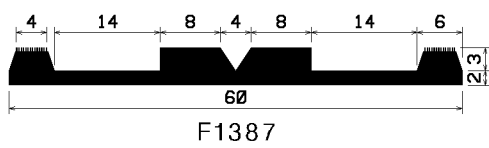
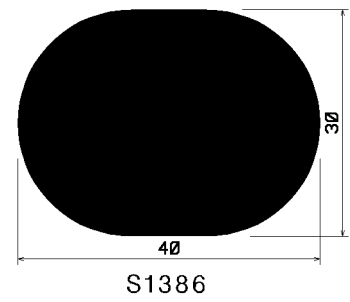
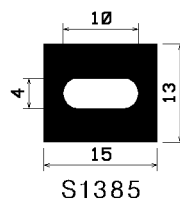
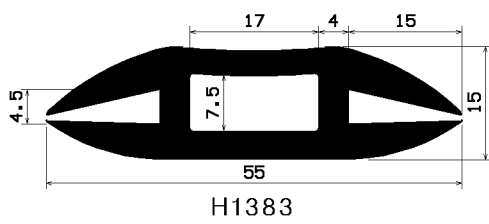
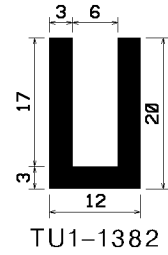
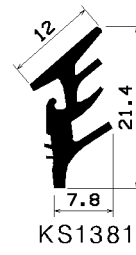
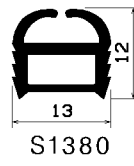
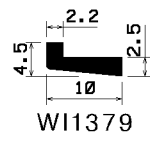
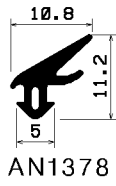
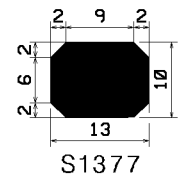
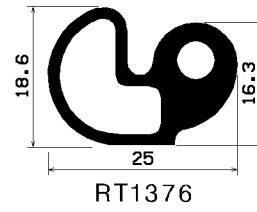
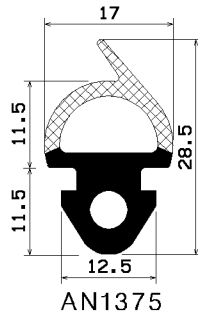
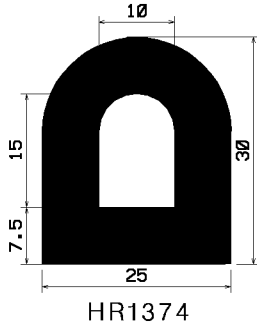
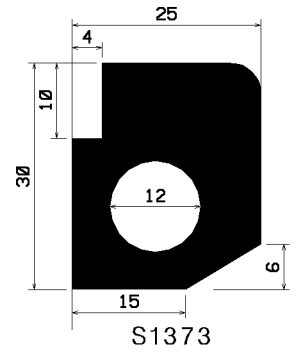
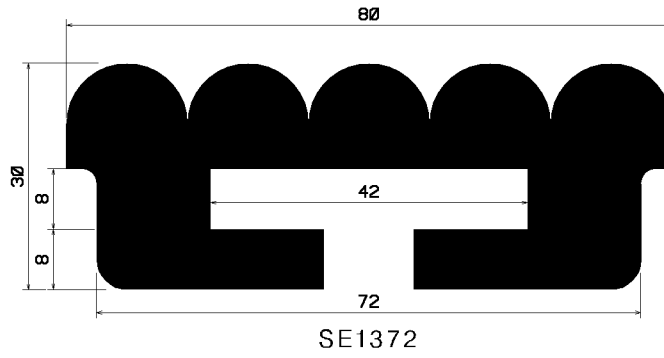
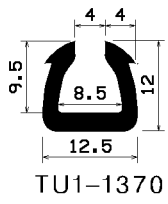

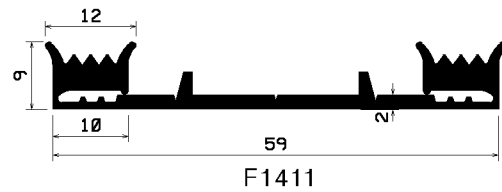
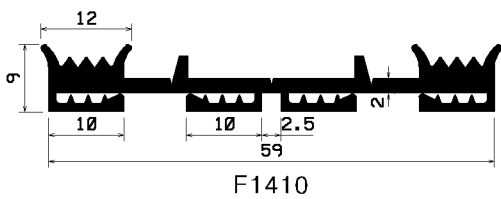
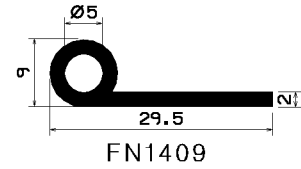
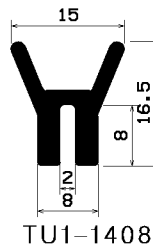
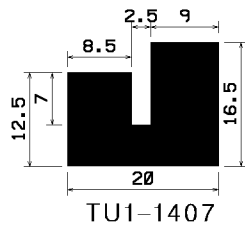
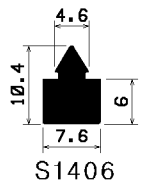
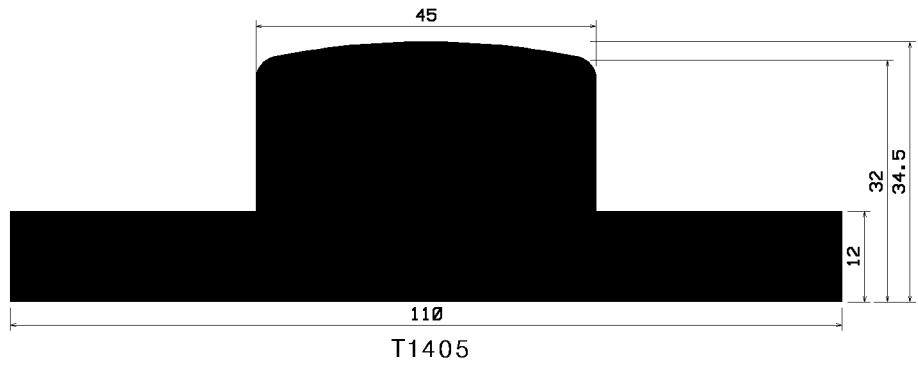
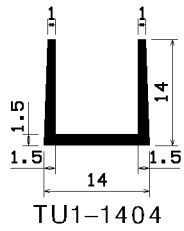
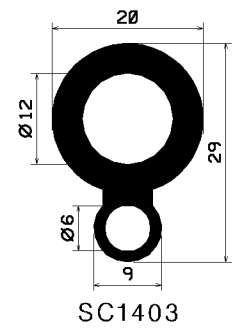
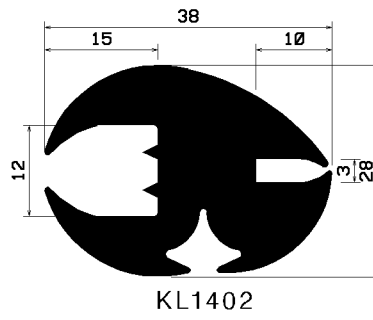
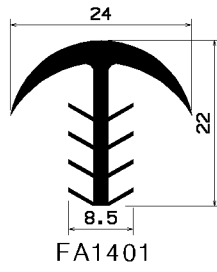
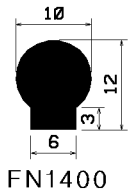
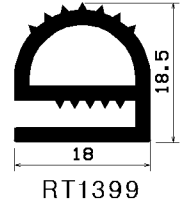
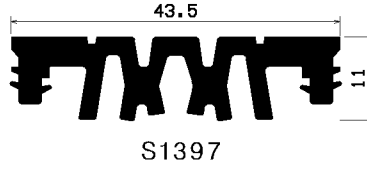
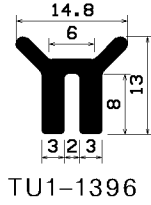
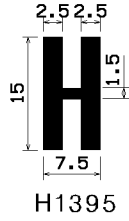
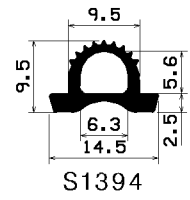
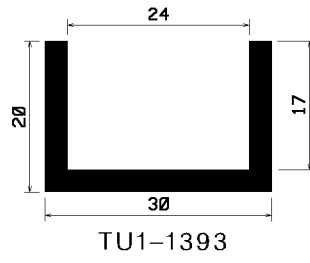
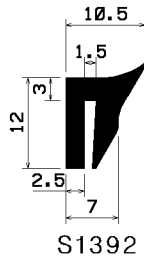
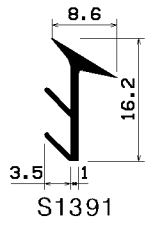
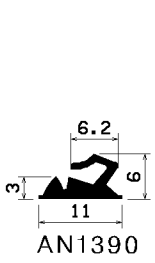

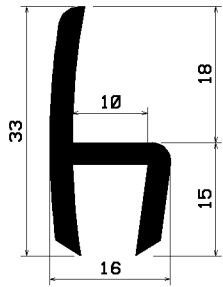

H1412

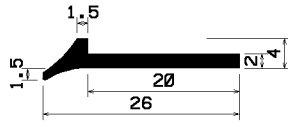

S1413

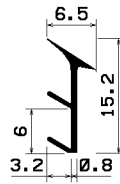

S1415

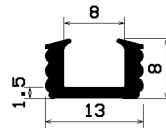

TU1-1416

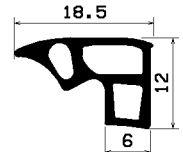

Z1-1417

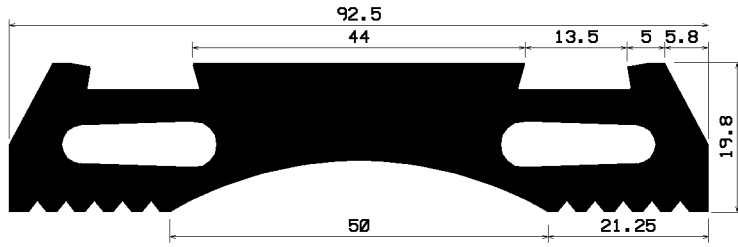

S1414

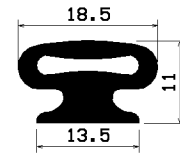

S1418

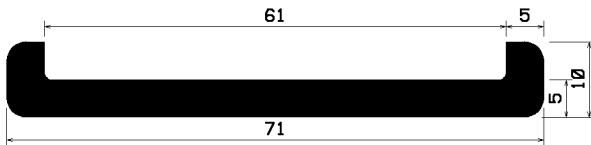

TU1-1419

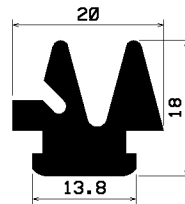

S1421

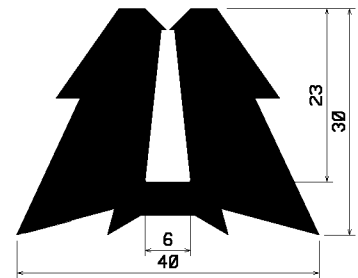

S1422



F1420

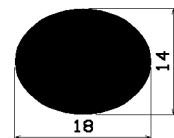

S1423

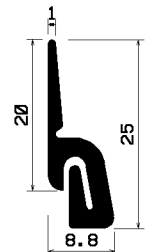

S1424

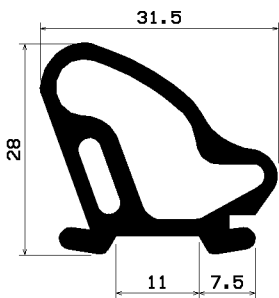

RT1425

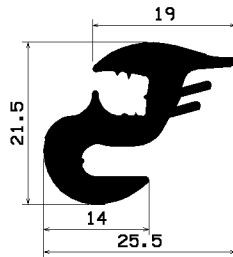

S1426

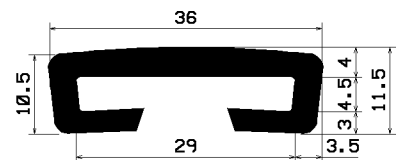

SE1427

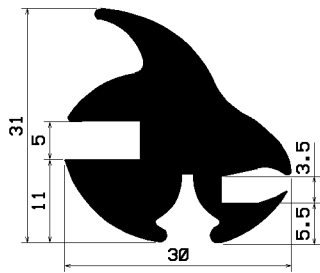

KL1428

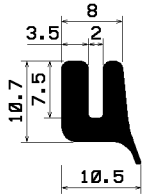

TU1-1429

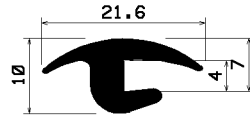

S1430

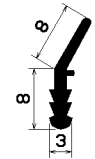

AF1431



F1432

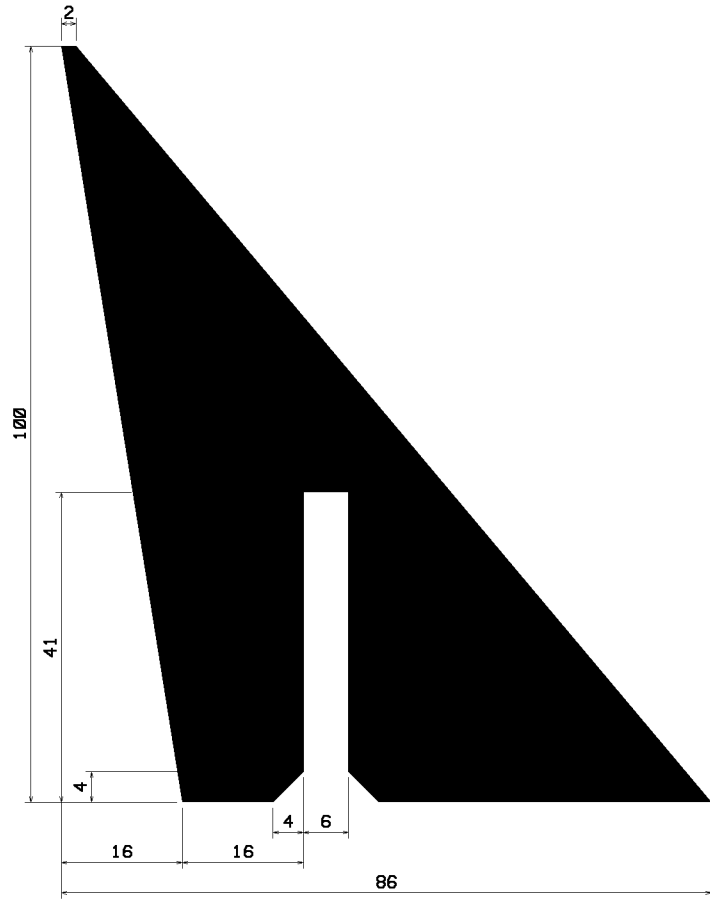

S1434

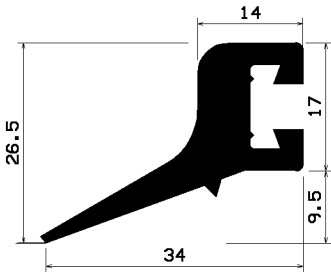

S1433

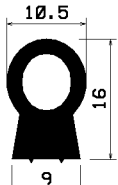

SC1435

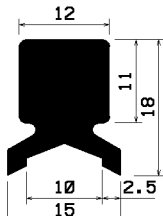

S1436

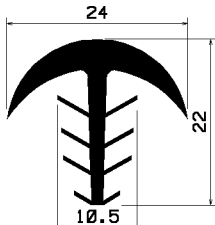

FA1437

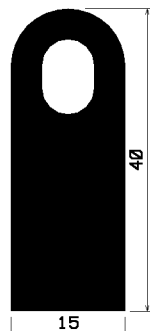

HR1438

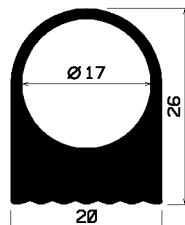

HR1439

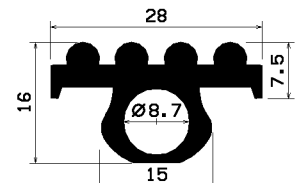

S1440

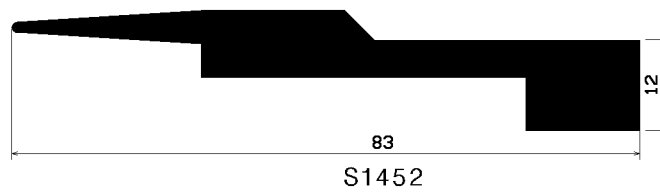
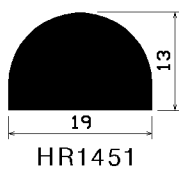
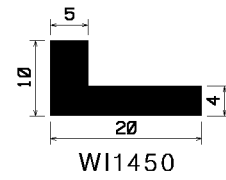
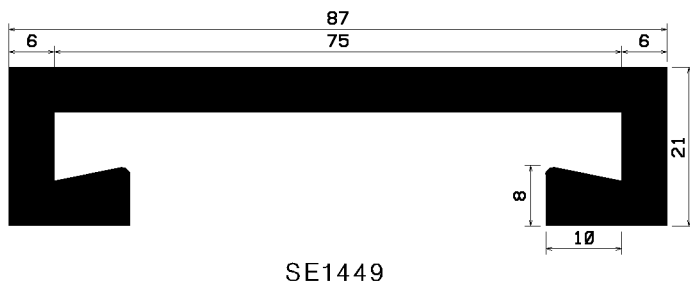
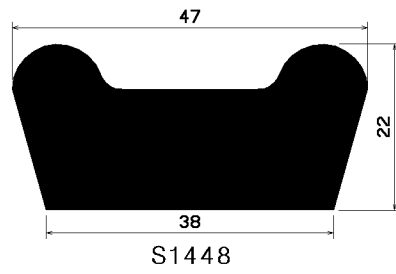
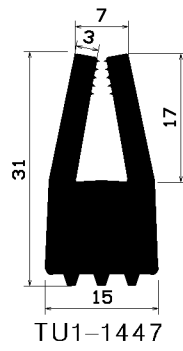
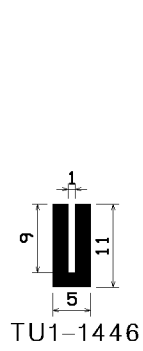
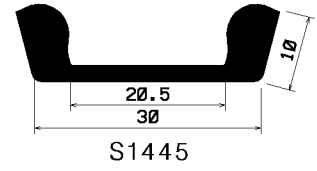
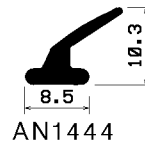
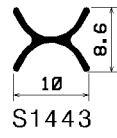
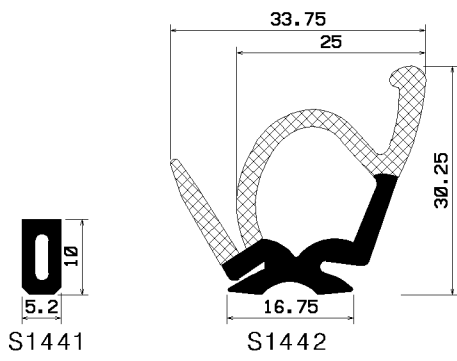

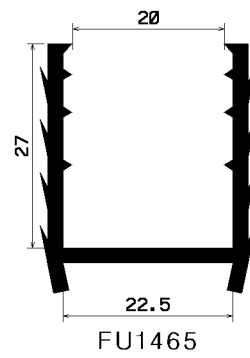
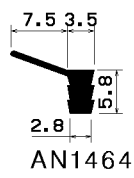
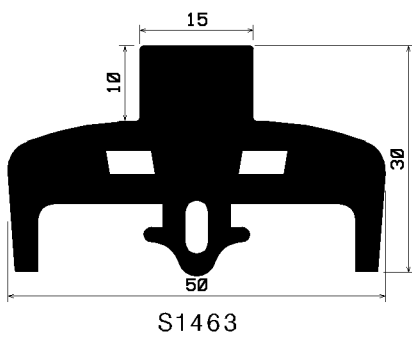
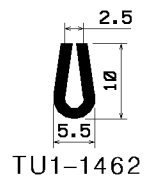
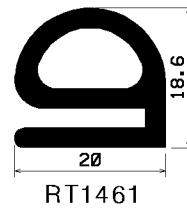
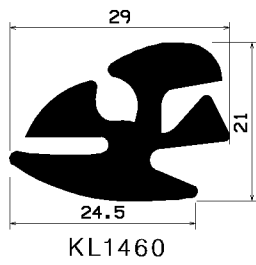
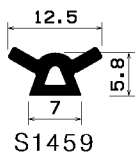
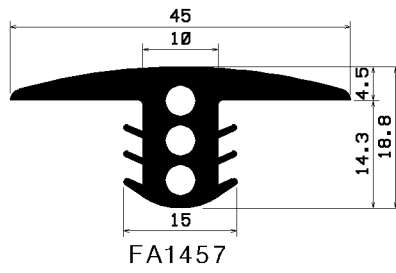
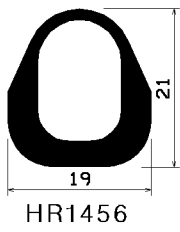
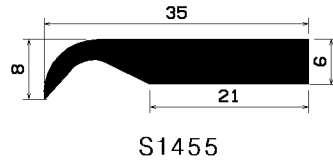
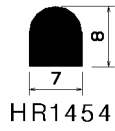
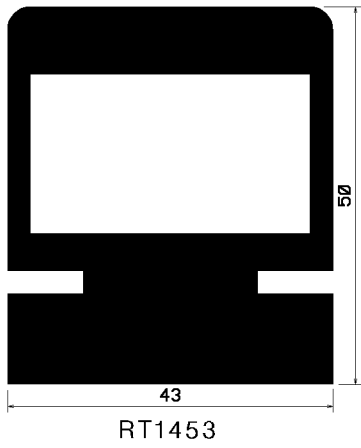

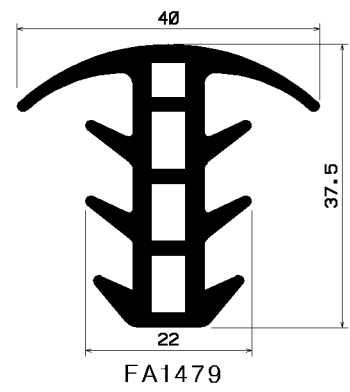
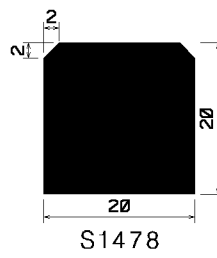
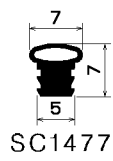
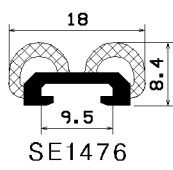
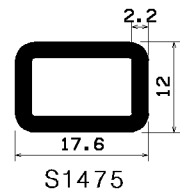
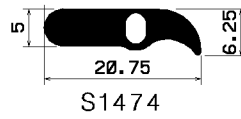
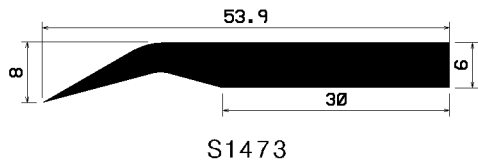
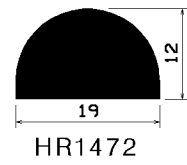
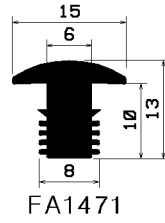
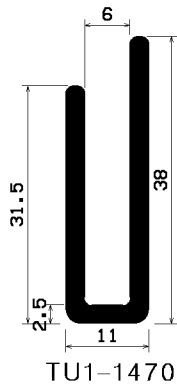
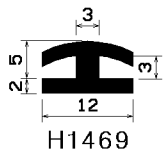
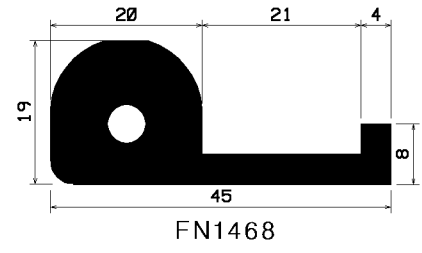
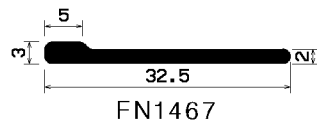
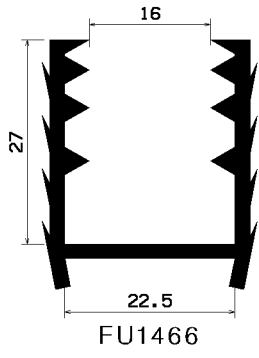

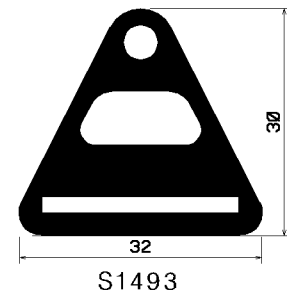
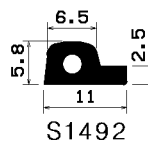
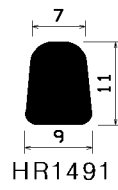
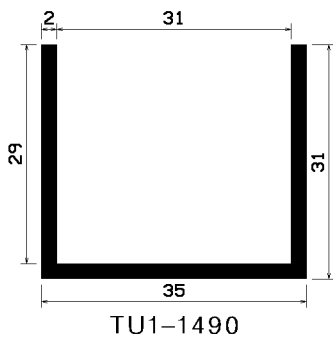
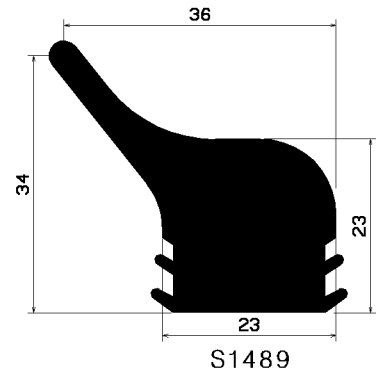
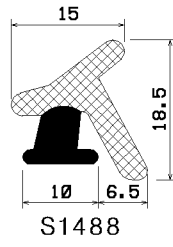
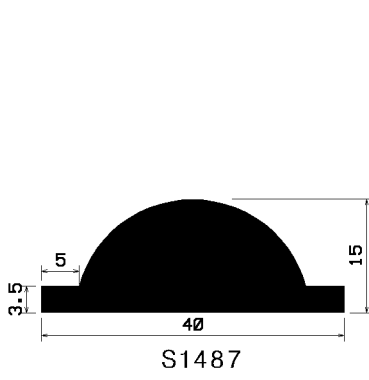
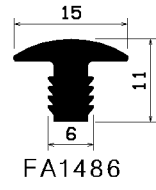
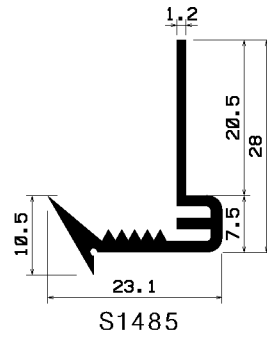
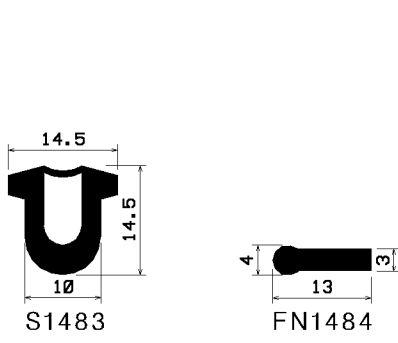
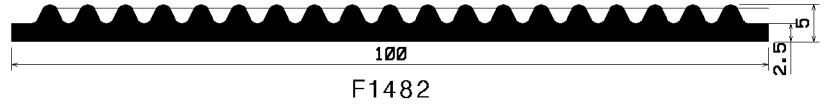
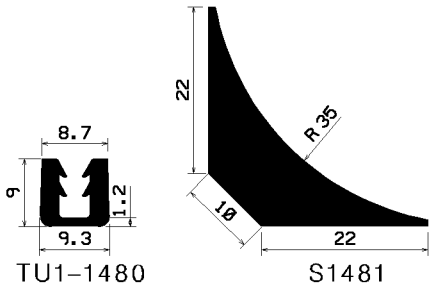

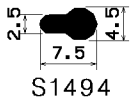

S1494

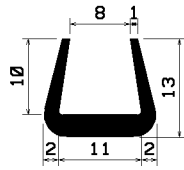

TU1-1495

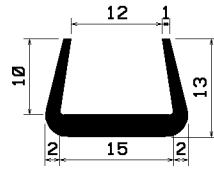

TU1-1496

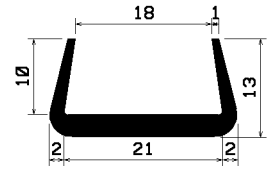

TU1-1497

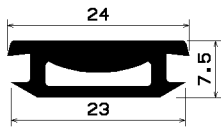

S1498



S1499

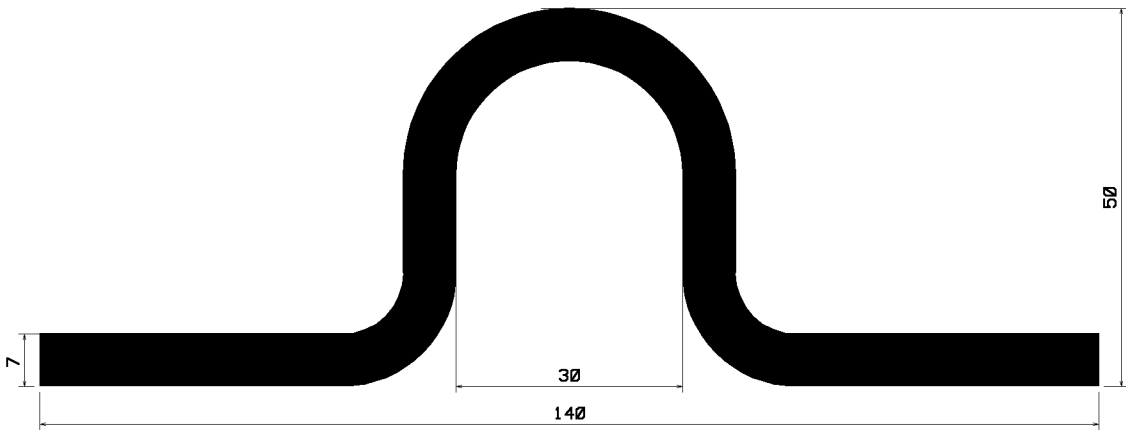

S1500

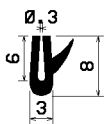

TU1-1501

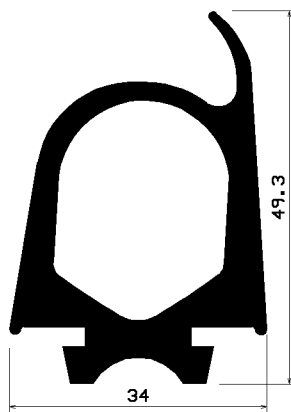

RT1502

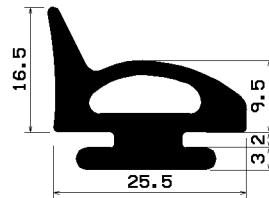

RT1503

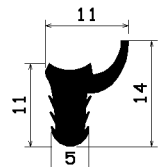

AN1504