



**Profile aus Gummi, Moosgummi,
Silikon, Schaumsilikon**

D-64579 Gernsheim

Otto-Hahn-Straße 12

Telefon 0 62 58 / 932250

Telefax 0 62 58 / 4997

e-mail: schild@gummi-plast.de

internet: <http://www.gummi-plast.de>

PROFIL-Liste

Teil 5

Profil-Nr. S 1505 bis S2705

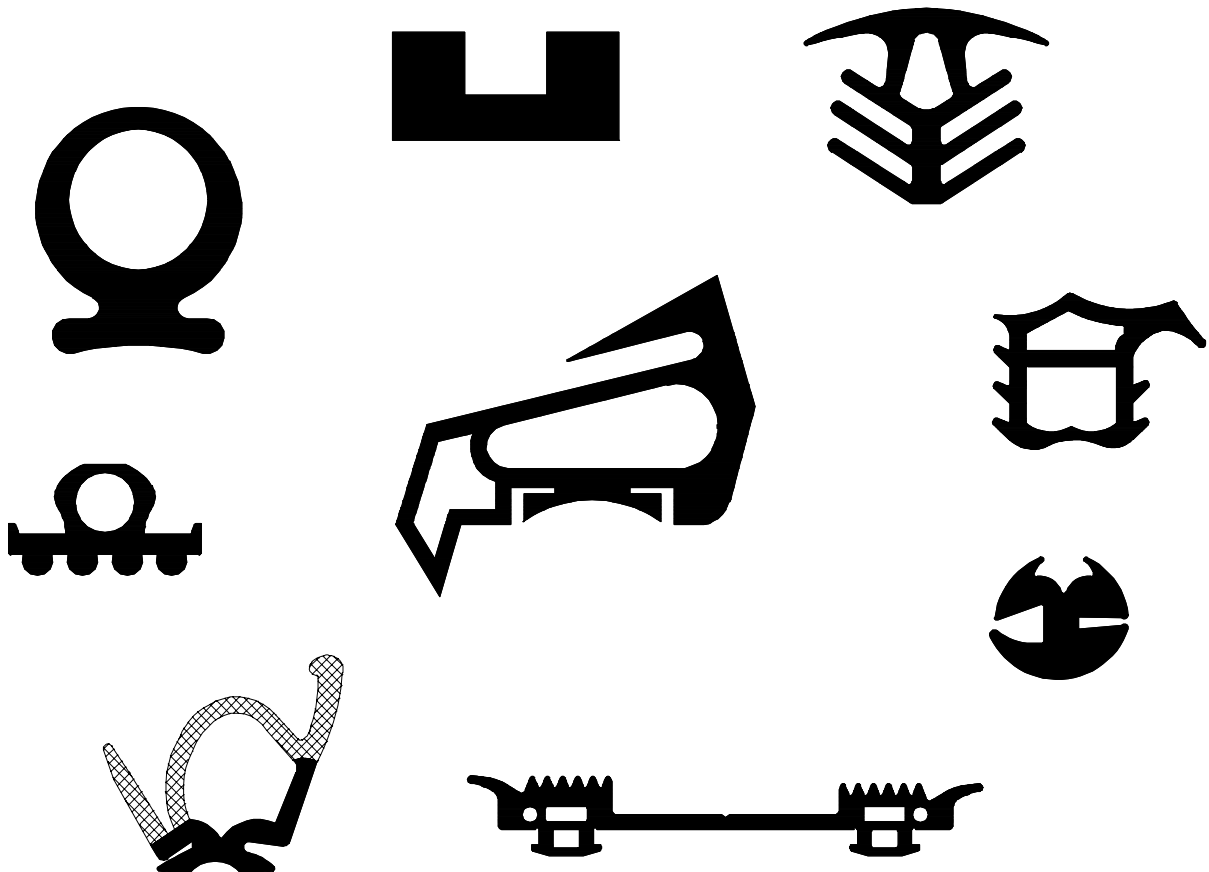

Wichtige Informationen!

Mit dieser Profil-Liste stellen wir Ihnen eine Auswahl aus unserem reichhaltigen Profilsortiment vor. Der Katalog informiert Sie über Art und Größe der Profile, die wir im Rahmen unseres Fertigungsprogramms herstellen.

Wir möchten Sie darauf hinweisen, dass bei einigen Profilen Kundenschutz besteht.

Natürlich fertigen wir auch Ihre Profile aus Gummi, Weich-PVC, Moosgummi, Silikon und Silikonschaum nach Zeichnung oder Muster.

Die Abkürzungen vor den Profil-Nummern bedeuten:

AF	= Allgemeine Fensterdichtungs-Profile
AN	= Anschlag-Profil
AU	= Auflage-Profile
F	= Fassaden-Profile
FA	= Fugenabdeck-Profile
FN	= Fahnen- (Noten-) Profile
FR	= Füller-Profile
FT	= Formteil
FU	= Fenster-U-Profile
GIR	= Gummi-Rundschnüre
GIV	= Gummivierkant-Profile
H	= H-Profile
HF	= Holzfenster-Profile
HR	= Halbrund-Profile
K	= Kühlschranks-Profile
KL	= Klemm-Profile
KS	= Keil- und Steck-Profile
MD	= Mitteldichtungs-Profile
RI	= Riefen-Profile
RT	= Rolltor- und Fingerschutz-Profile
S	= Sonstige Profile
SC	= Schlauch-Profile
SE	= Schellen-Profile
SL	= Siebleisten-Profile
T	= T-Profile
TR	= Trapez-Profile
TU1-	= Technische-U-Profile
VP	= Verglasungs-Profile
WI	= Winkel-Profile
Z1-	= Zargen-Profile

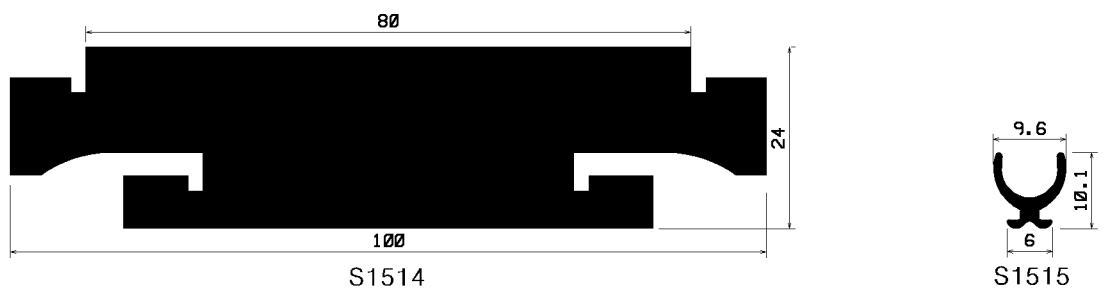
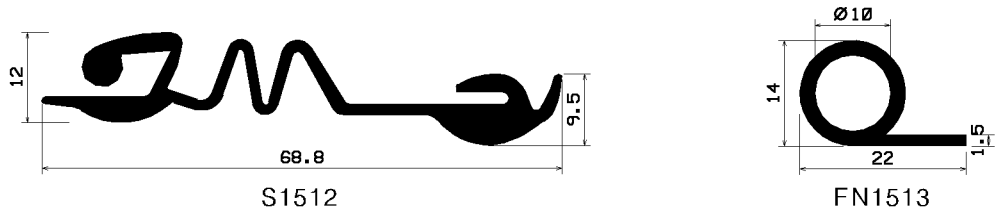
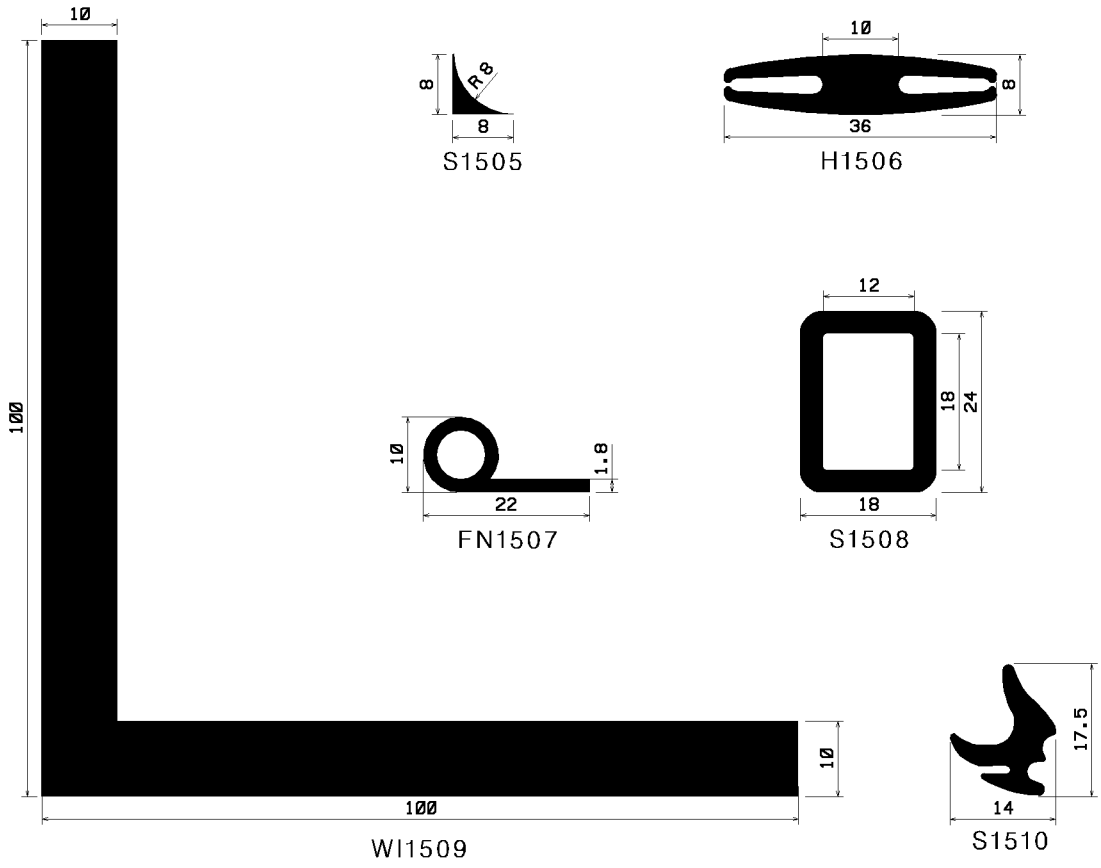

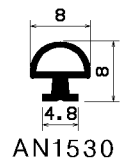
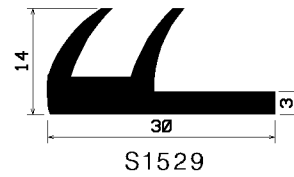
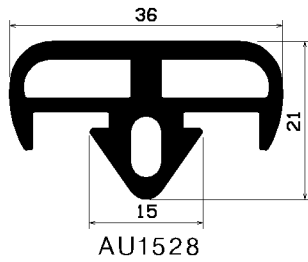
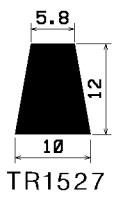
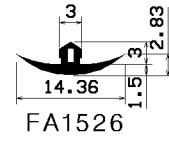
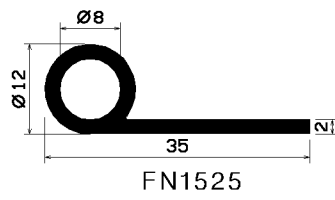
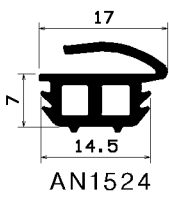
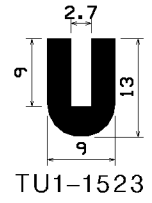
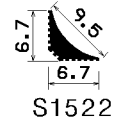
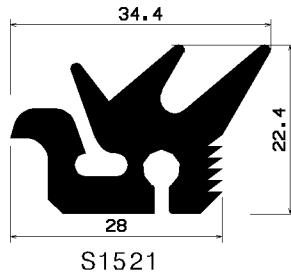
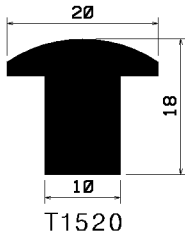
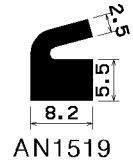
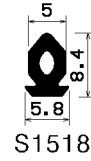
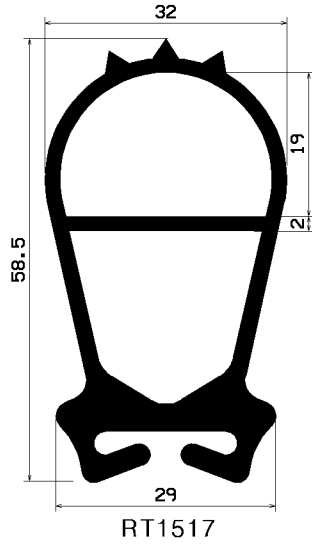
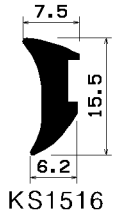

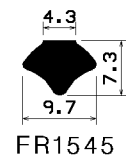
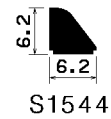
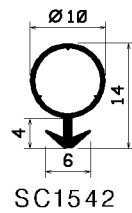
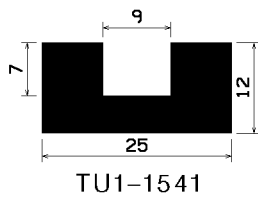
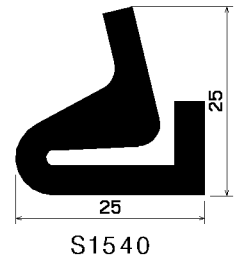
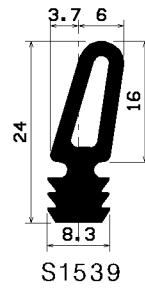
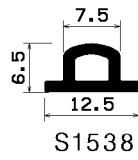
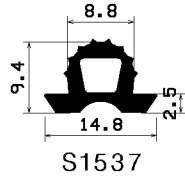
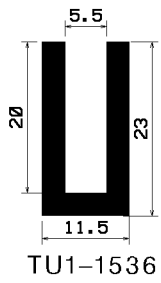
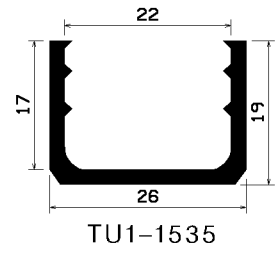
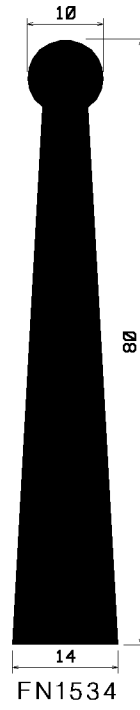
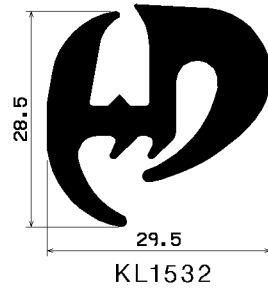
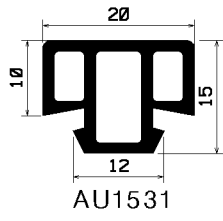

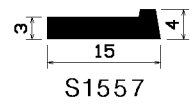
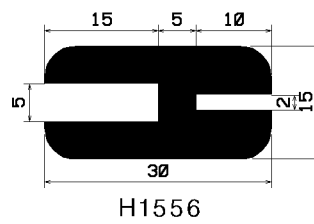
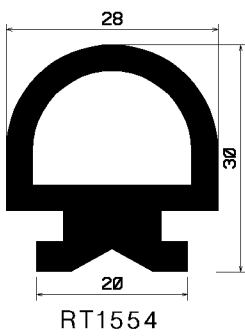
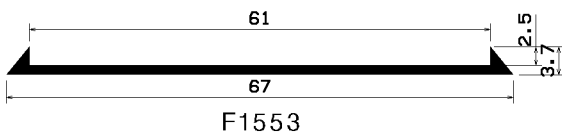
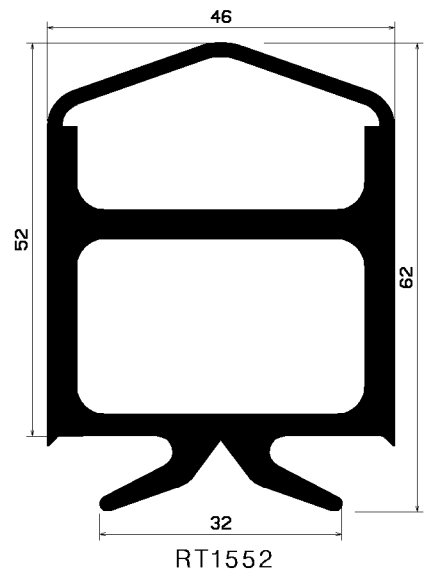
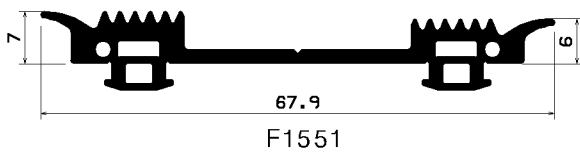
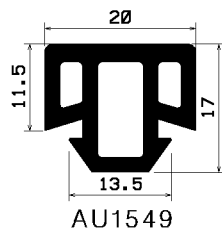
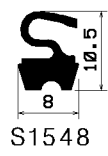
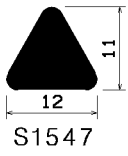
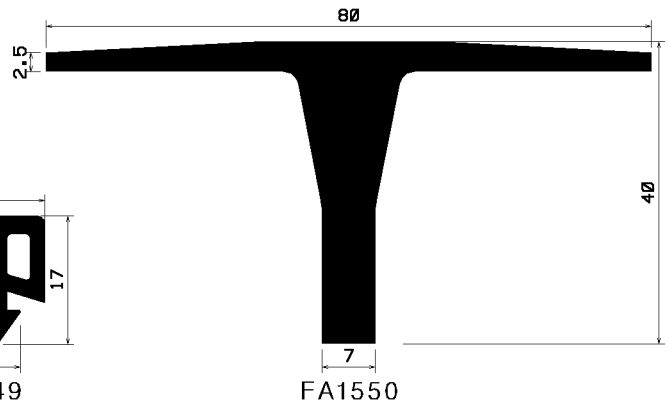
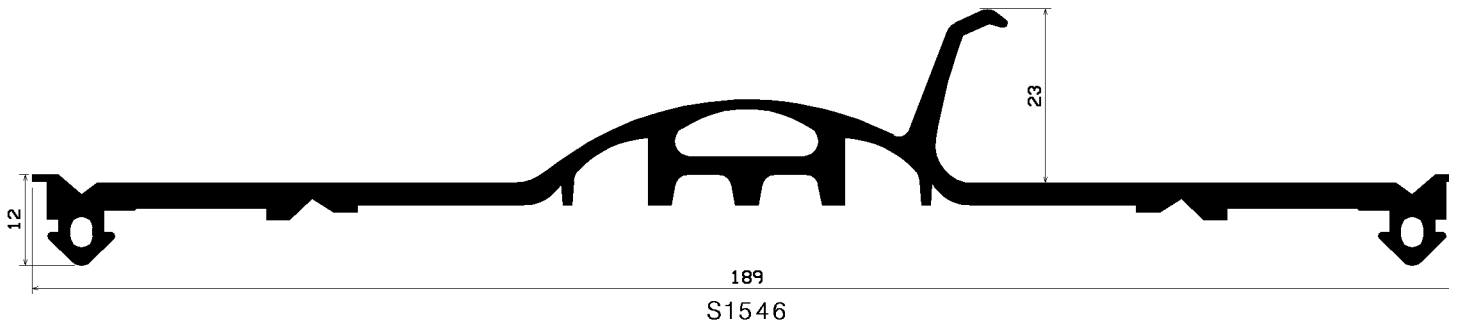

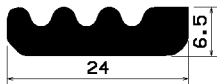

F1558

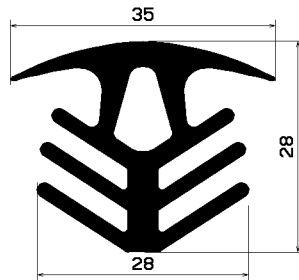

FA1559

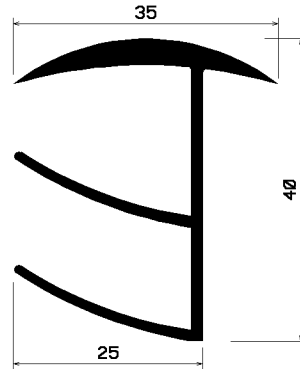

FA1560

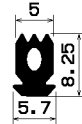

S1561

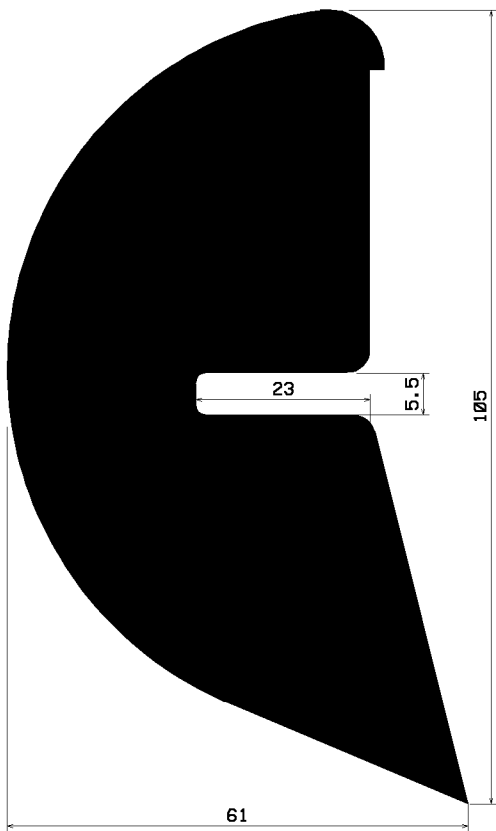

S1566

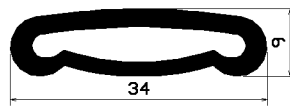

S1562

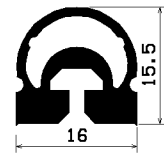

S1563

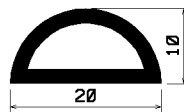

HR1564

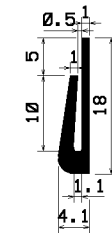

TU1-1565

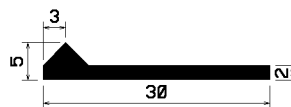

S1567

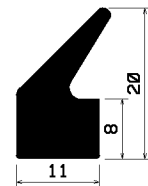

Z1-1568

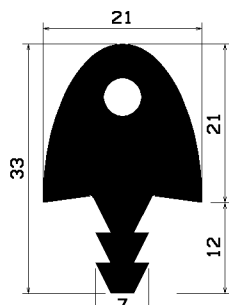

S1569

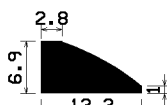

S1571

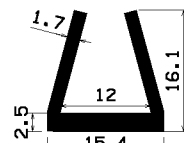

TU1-1572

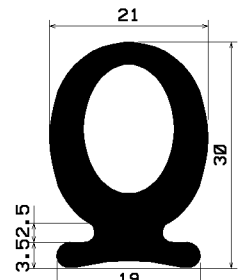

RT1573

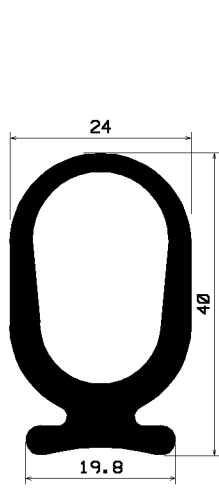

RT1574

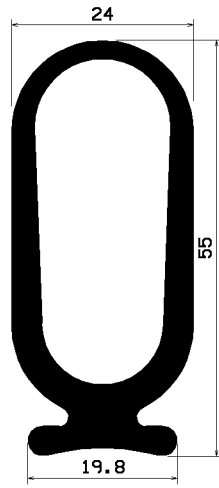

RT1575

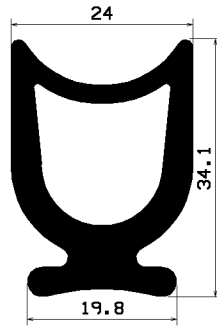

RT1576



S1577

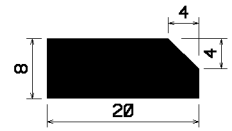

S1578

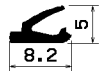

S1579

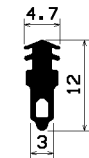

S1580

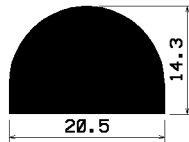

HR1581

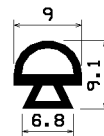

AN1582

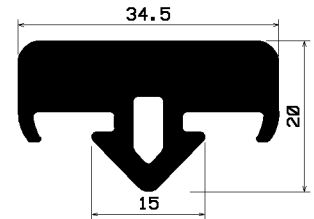

AU1583

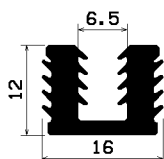

FU1584

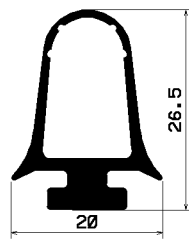

RT1585

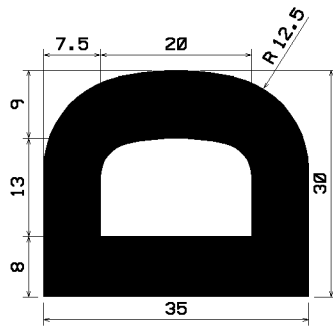

HR1586

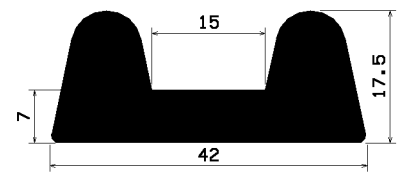

S1587

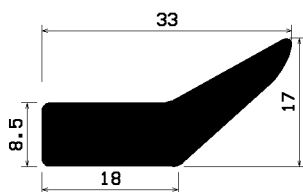

S1588



S1589

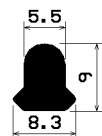

S1590

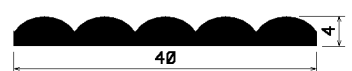

F1591

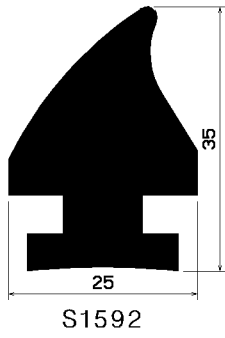

S1592

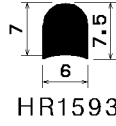

HR1593

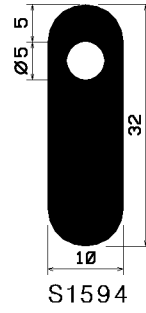

S1594

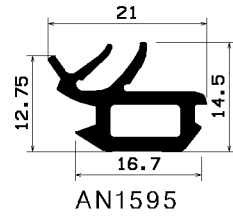

AN1595

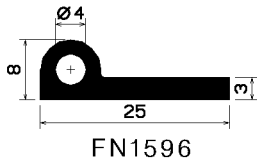

FN1596

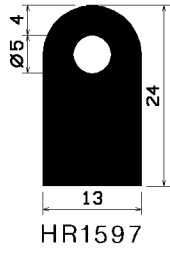

HR1597

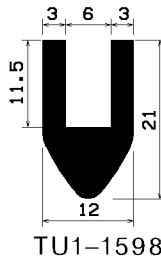

TU1-1598



TU1-1599

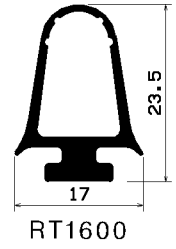

RT1600

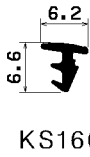

KS1601

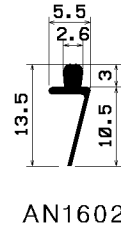

AN1602

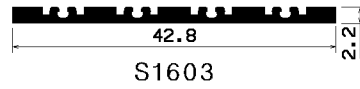

S1603

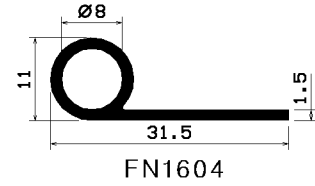

FN1604

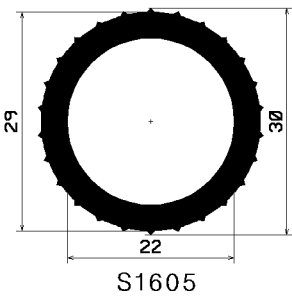

S1605

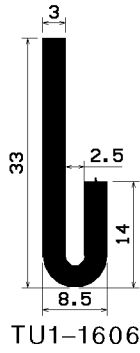

TU1-1606

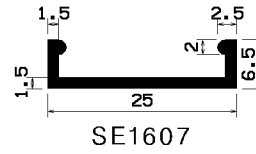

SE1607

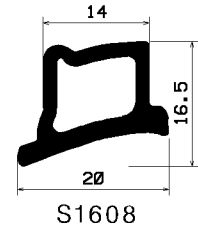

S1608

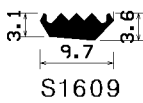

S1609

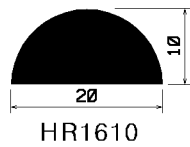

HR1610

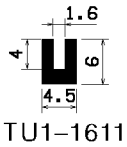

TU1-1611

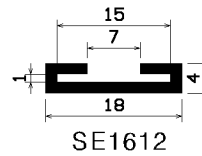

SE1612

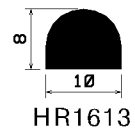

HR1613

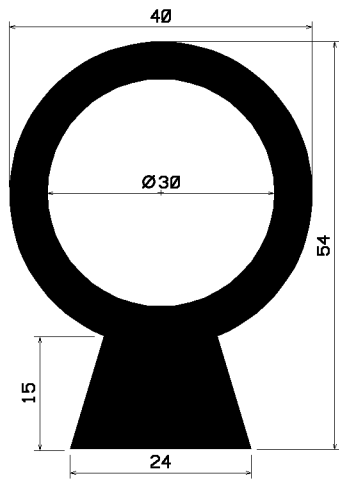

SC1614

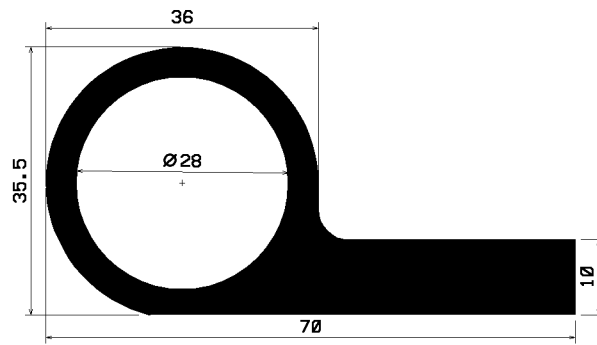

FN1615

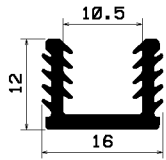

FU1616

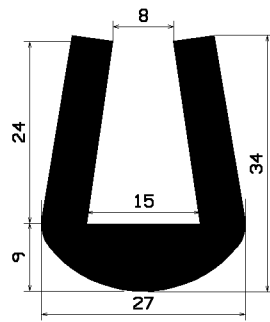

TU1-1617

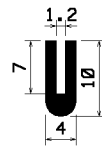

TU1-1618

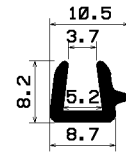

TU1-1619

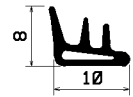

S1620

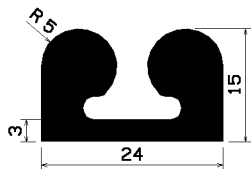

S1621

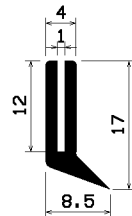

S1623

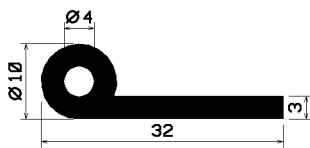

FN1624

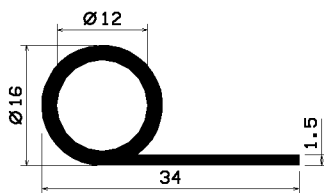

FN1625

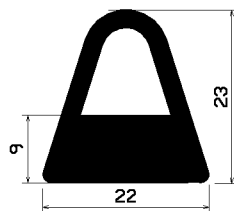

HR1626

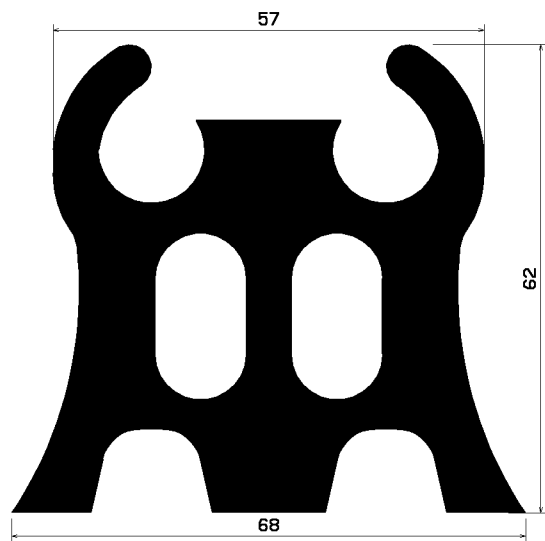

S1627

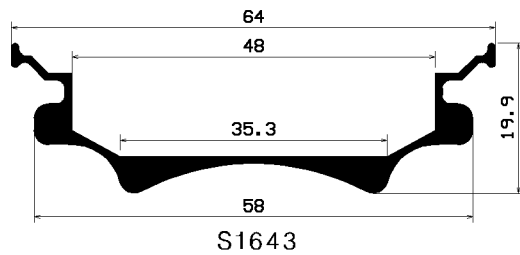
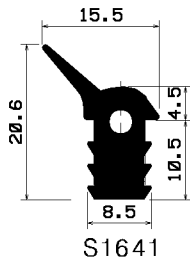
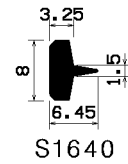
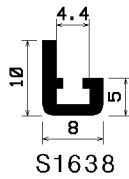
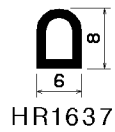
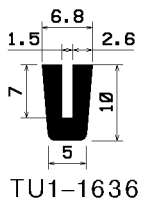
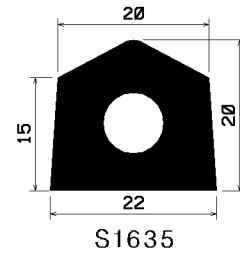
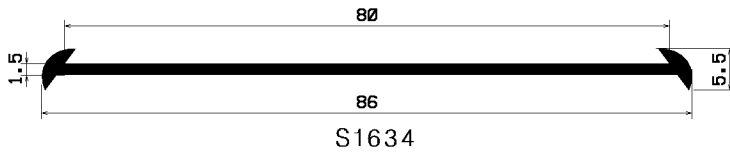
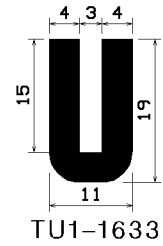
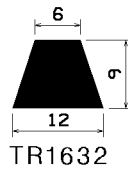
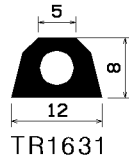
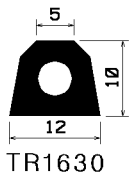
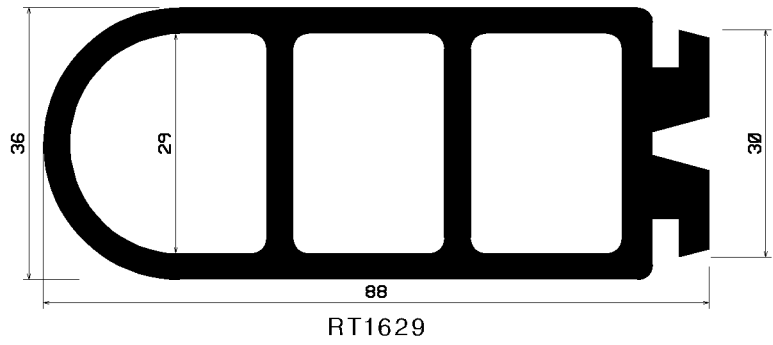
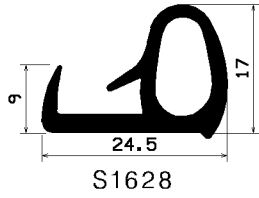

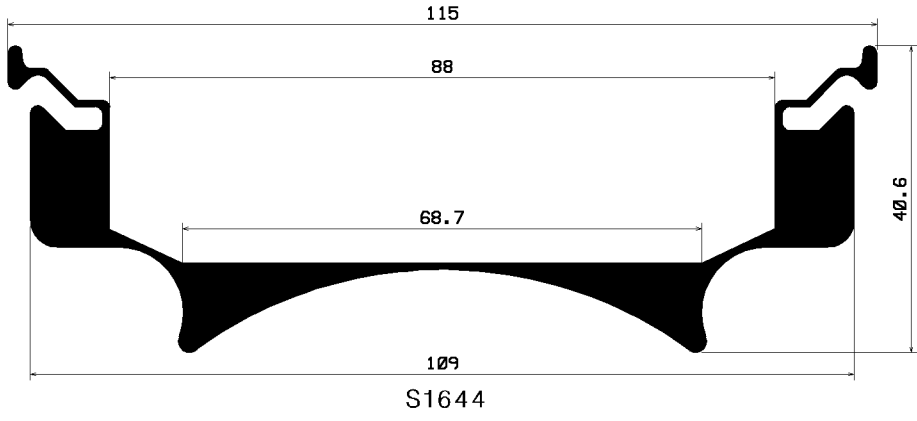

S1644

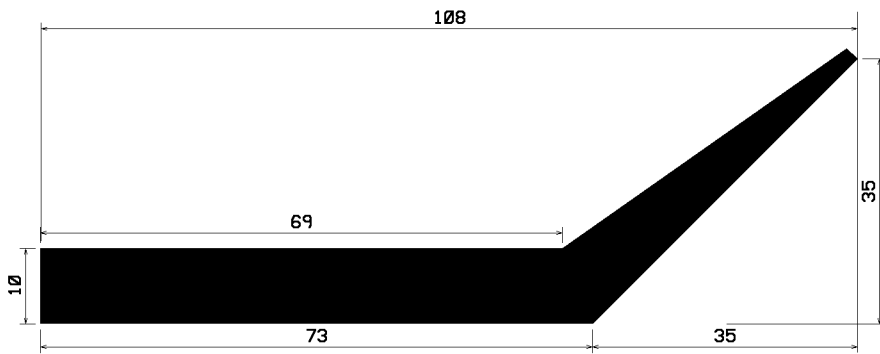

S1645

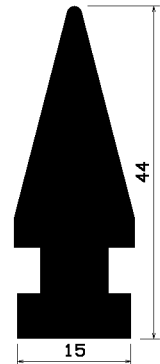

S1646

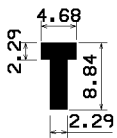

T1647

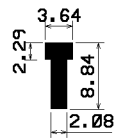

T1648

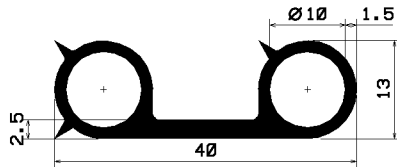

S1649

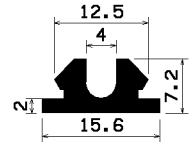

S1650

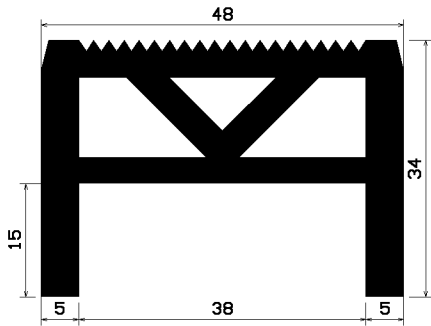

S1651

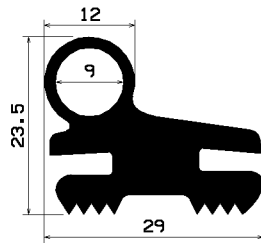

S1652

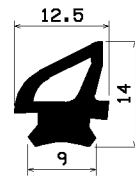

S1653

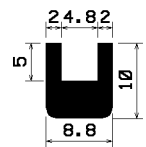

TU1-1654

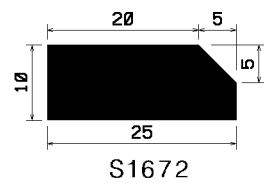
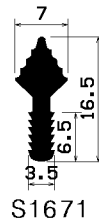
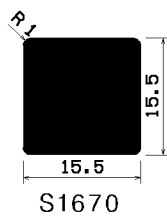
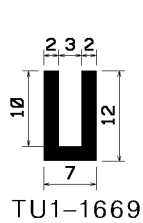
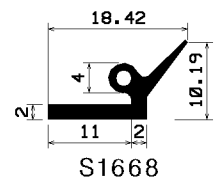
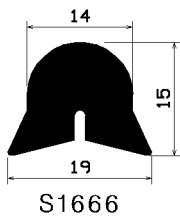
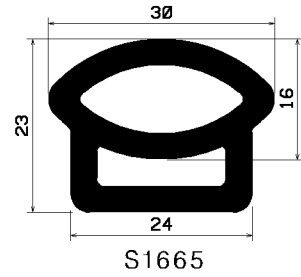
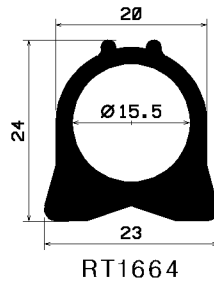
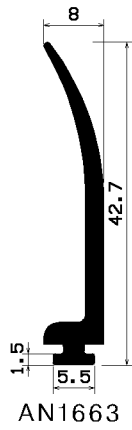
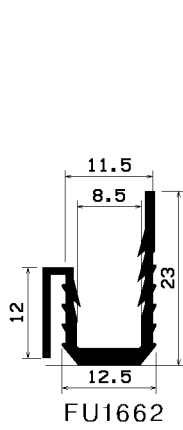
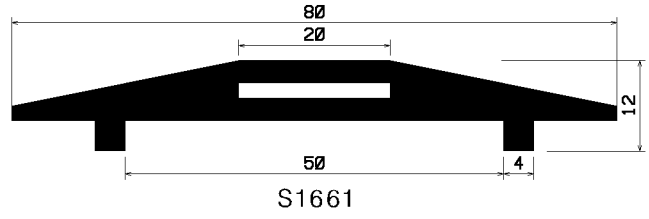
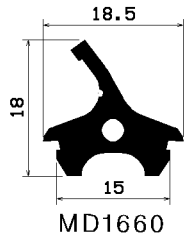
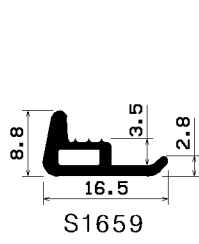
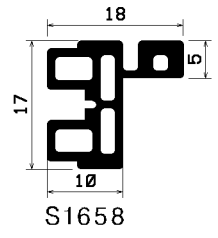
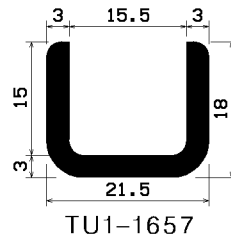
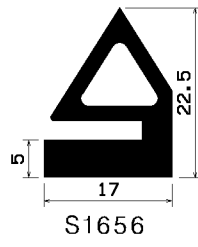
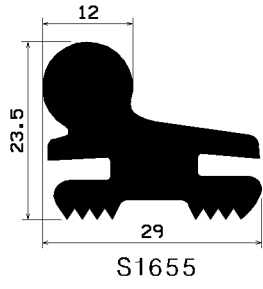

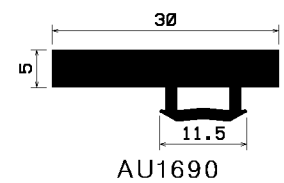
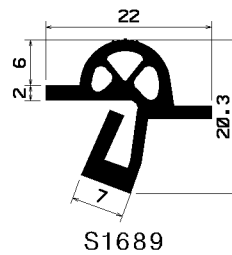
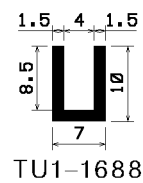
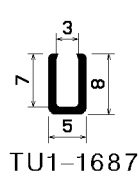
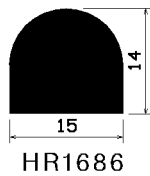
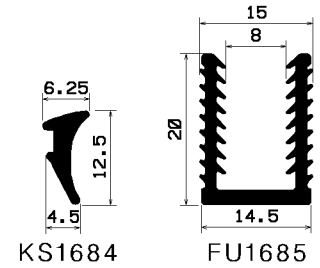
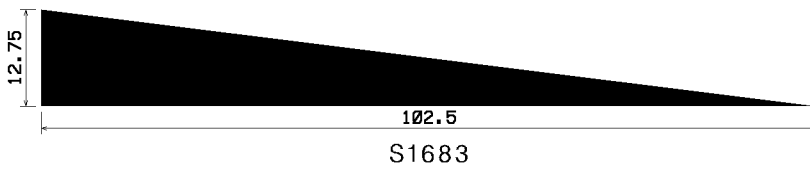
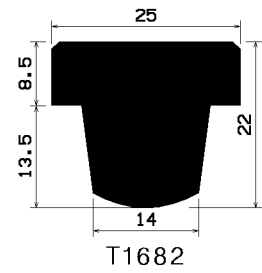
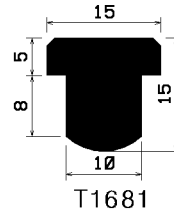
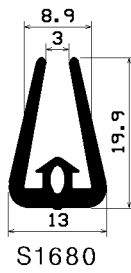
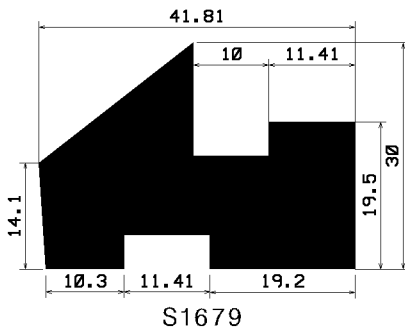
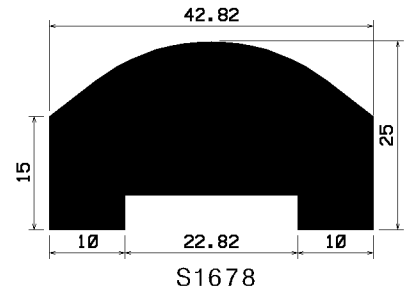
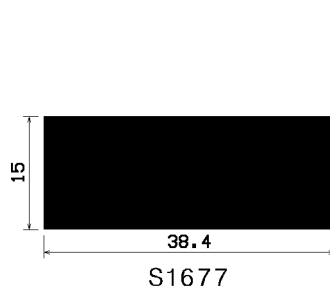
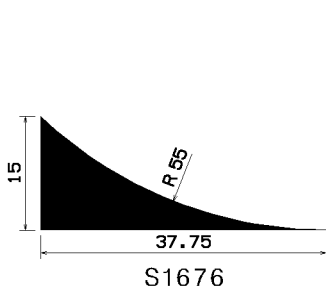
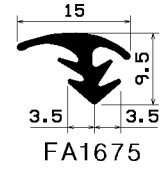
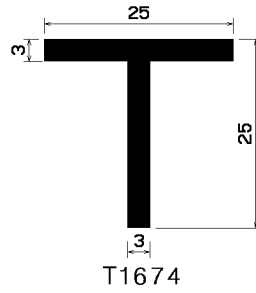
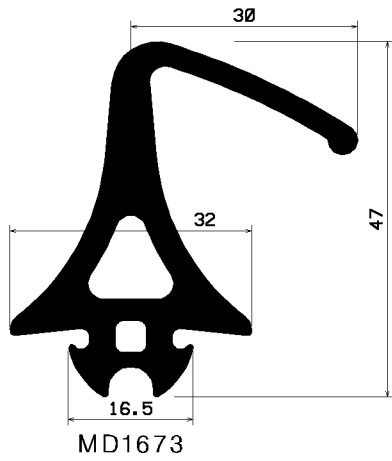

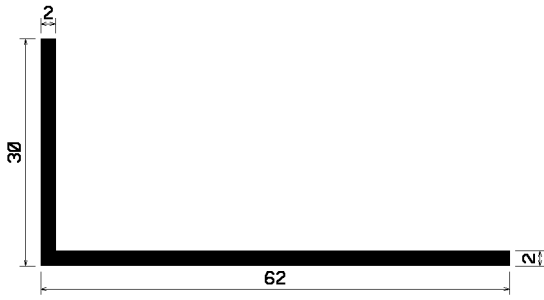

WI1691

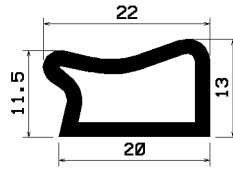

S1692

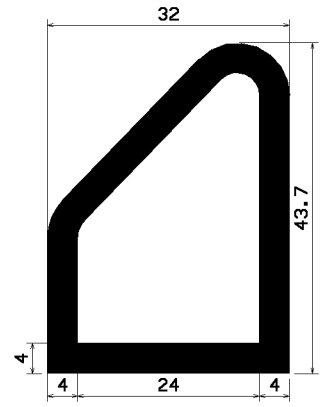

S1693

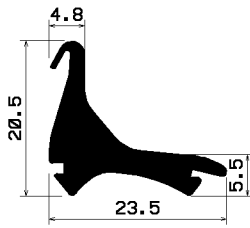

S1694

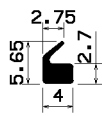

Z1-1695

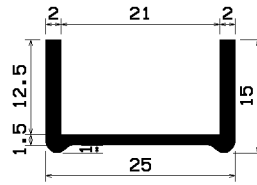

TU1-1696

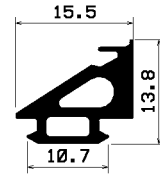

S1697

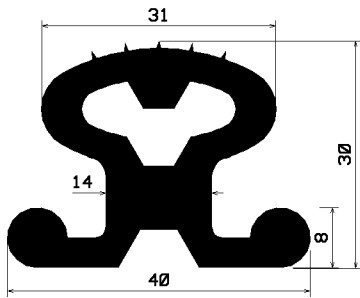

S1698

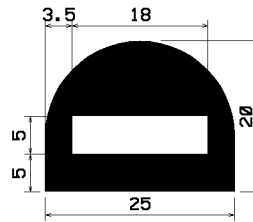

HR1699

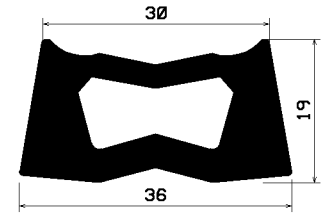

S1700

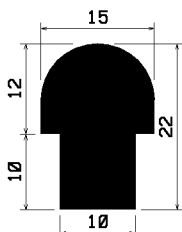

FA1701

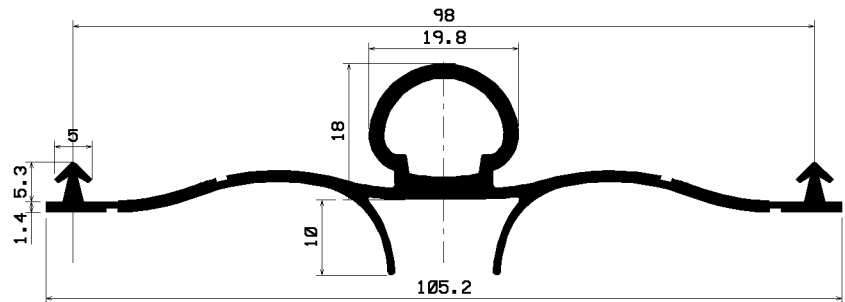

S1702

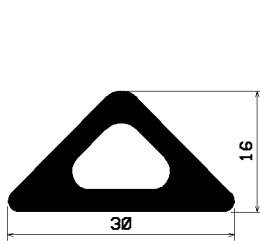

S1703

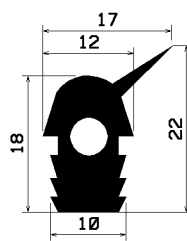

S1704

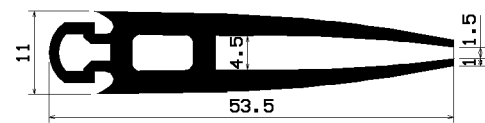

S1705

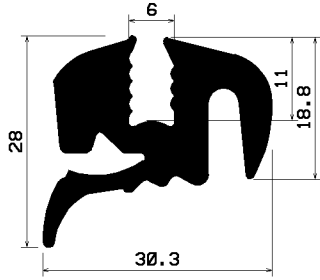

KL1706

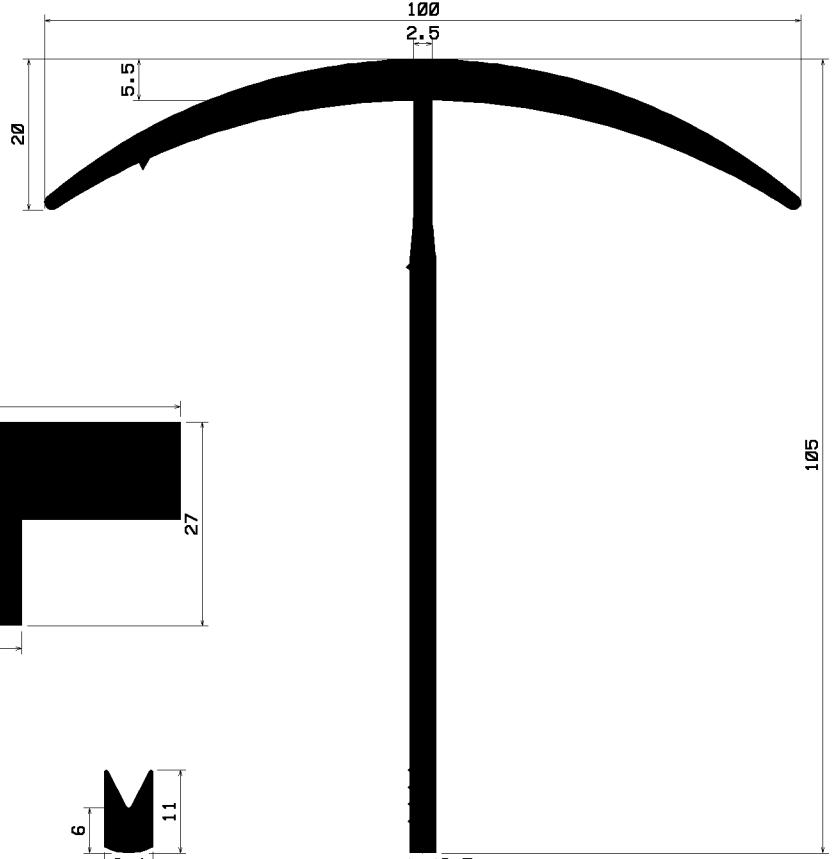

FA1711

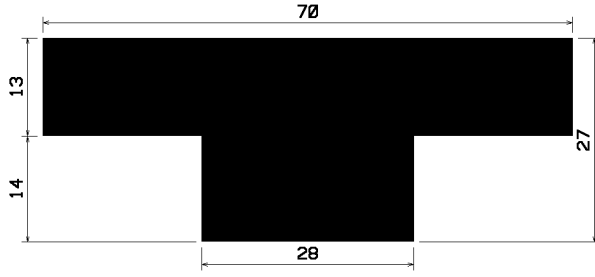

T1707

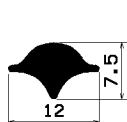

FR1708

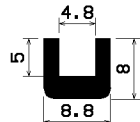

TU1-1709

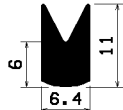

S1710

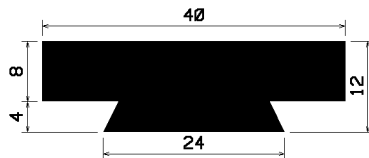

S1712

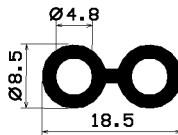

S1713

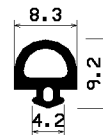

SC1714



KS1715

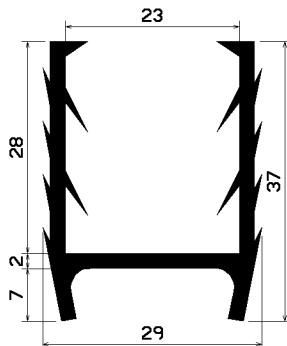

FU1716

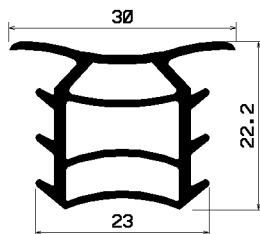

FA1717

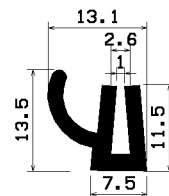

TU1-1718

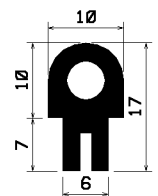

S1719

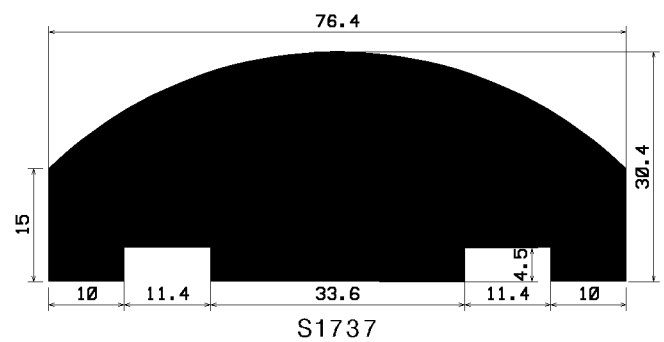
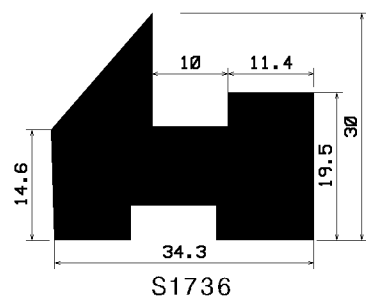
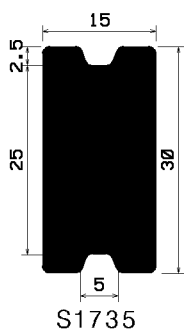
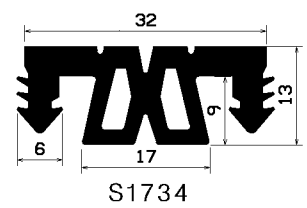
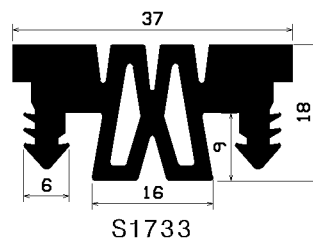
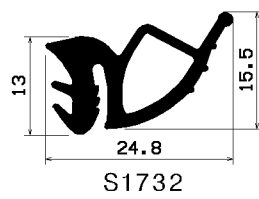
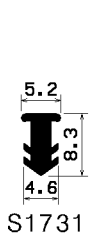
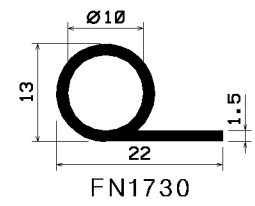
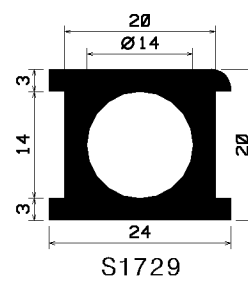
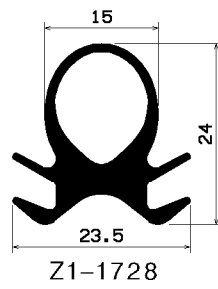
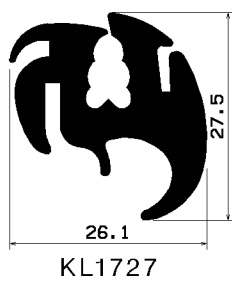
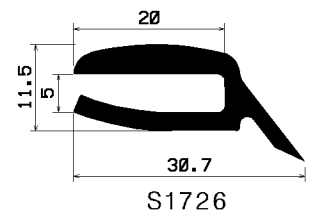
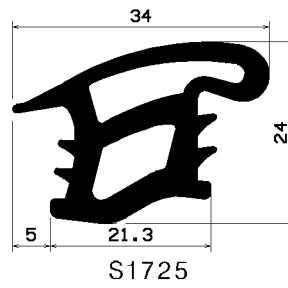
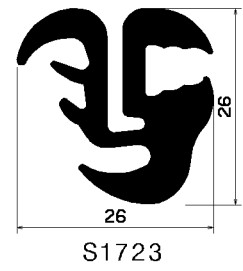
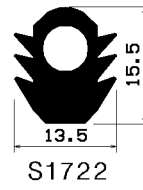
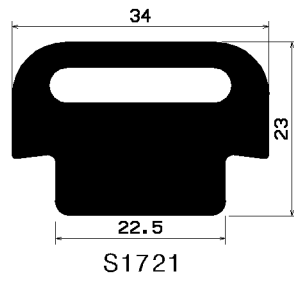
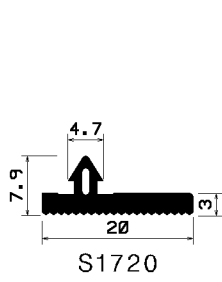

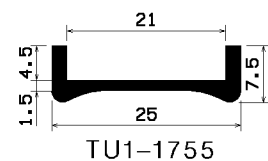
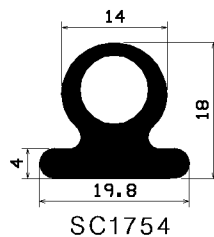
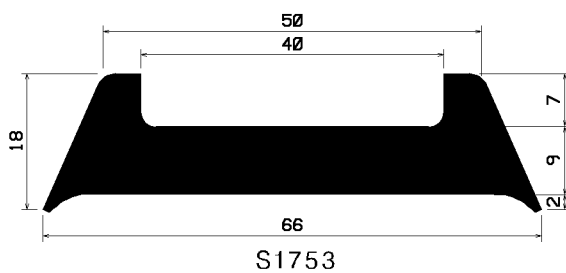
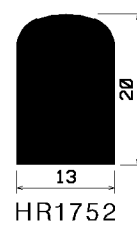
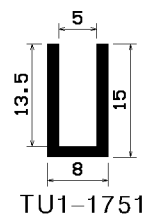
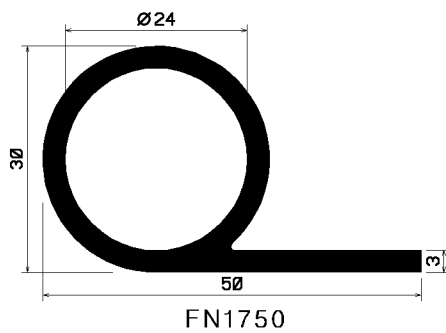
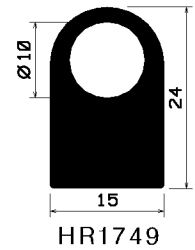
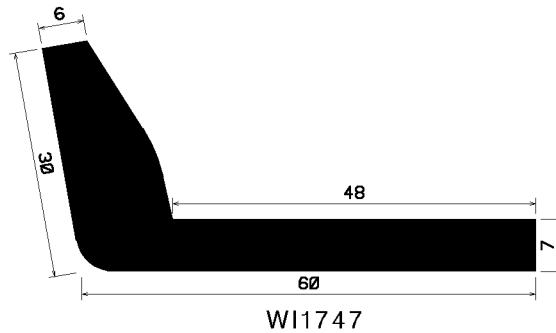
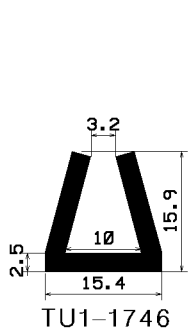
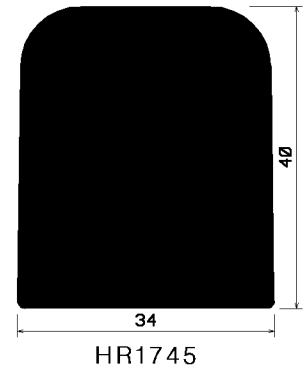
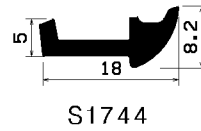
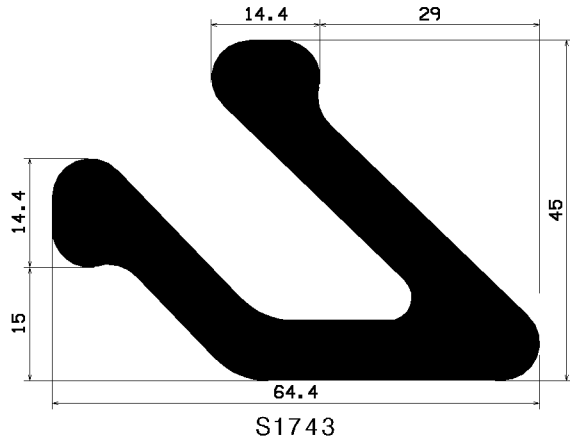
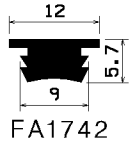
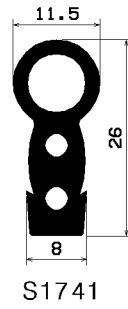
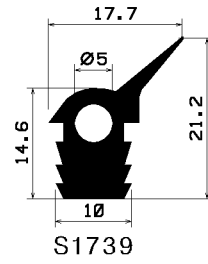
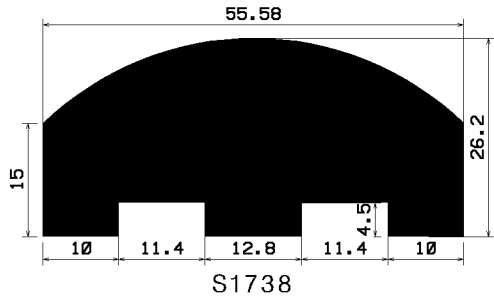

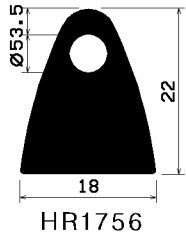

HR1756

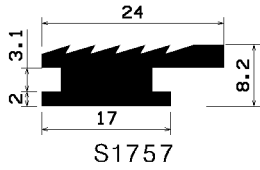

S1757

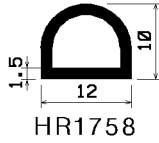

HR1758

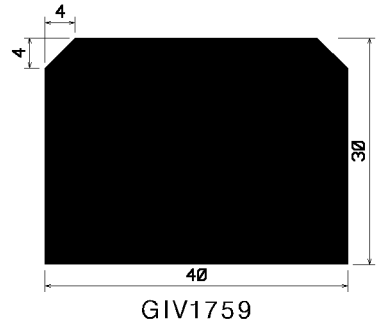

GIV1759

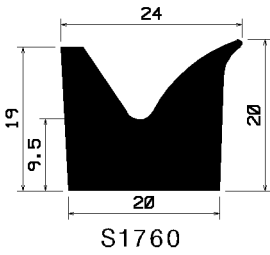

S1760

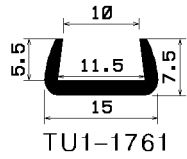

TU1-1761

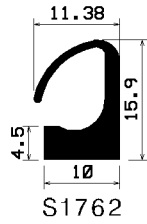

S1762

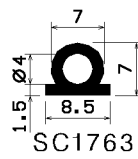

SC1763

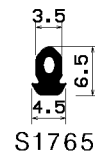

S1765

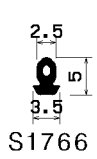

S1766

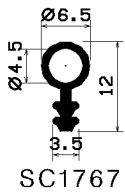

SC1767

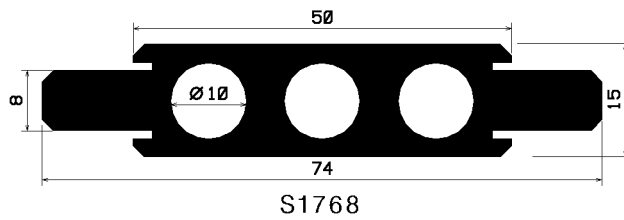

S1768

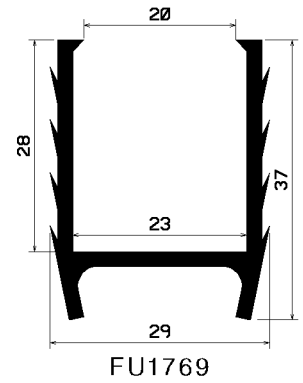

FU1769

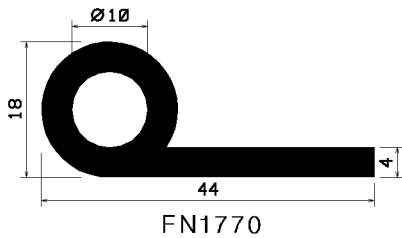

FN1770

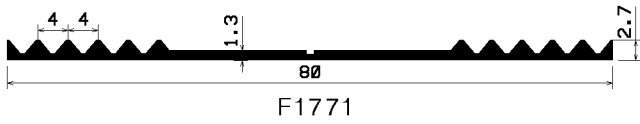

F1771

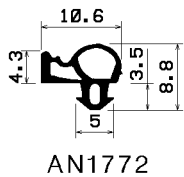

AN1772

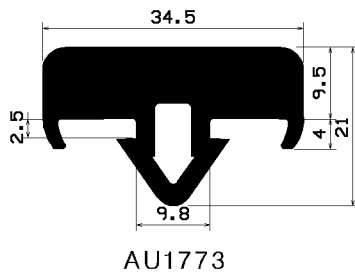

AU1773

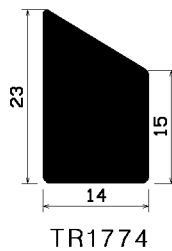

TR1774

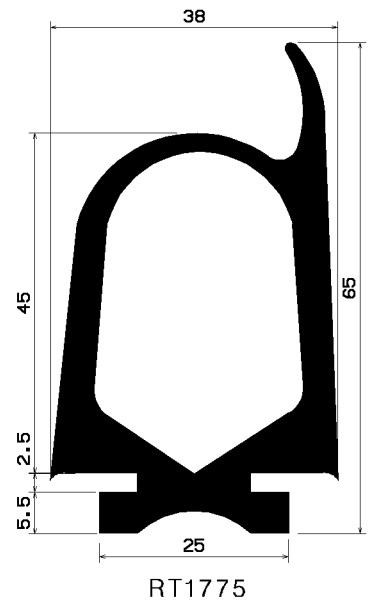

RT1775

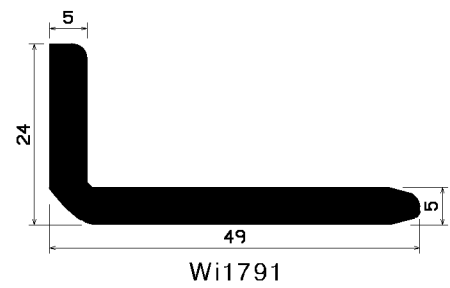
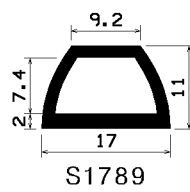
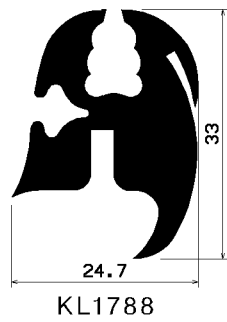
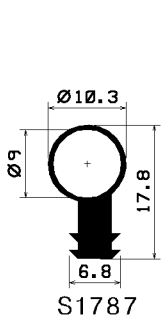
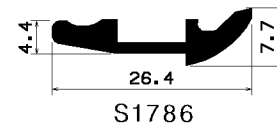
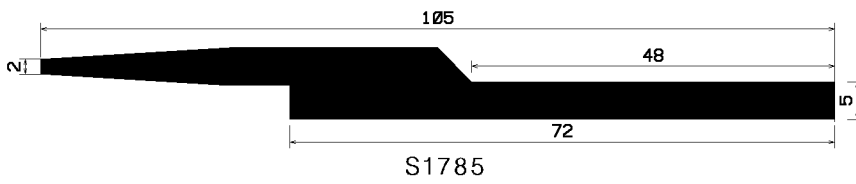
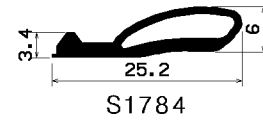
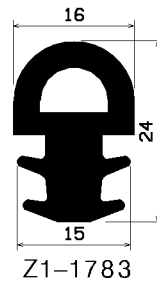
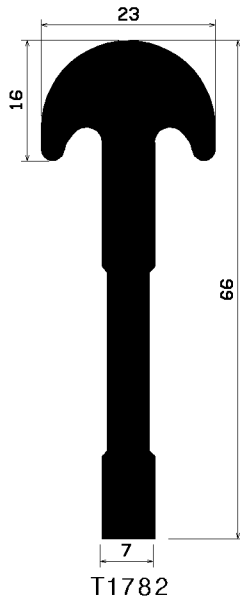
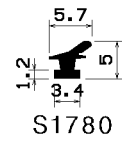
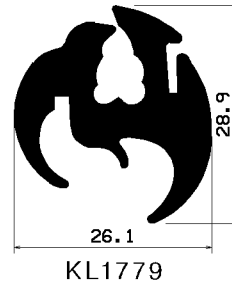
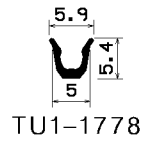
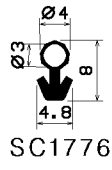

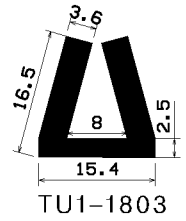
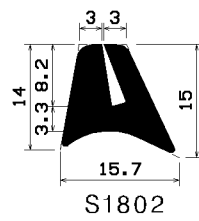
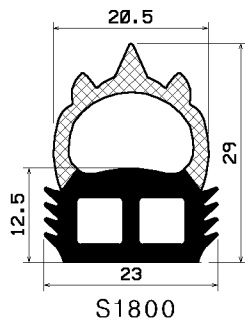
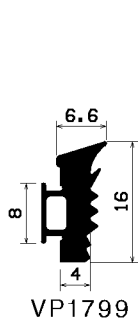
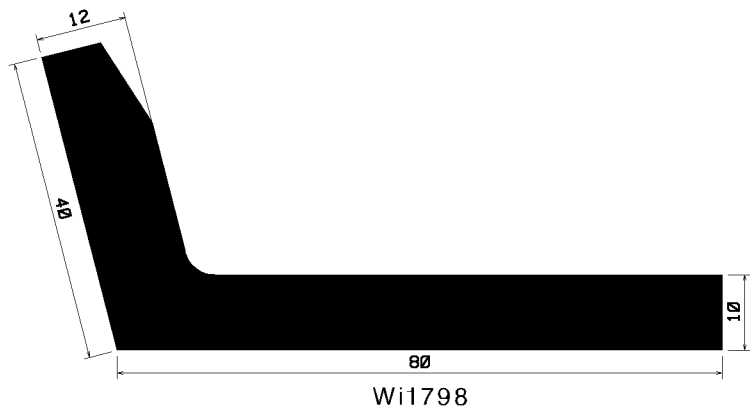
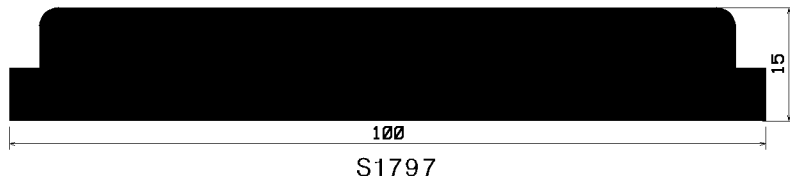
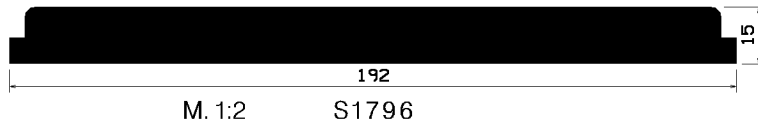
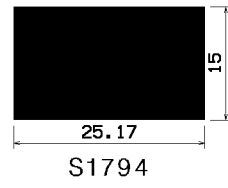
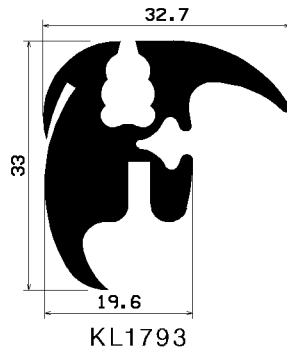
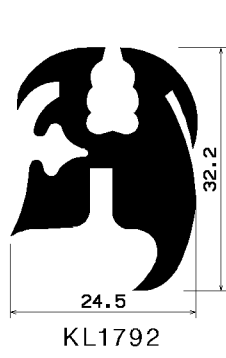

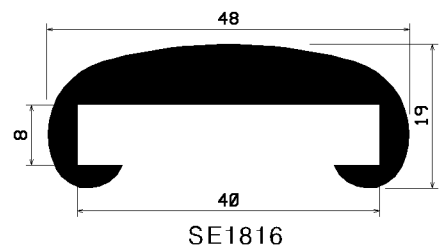
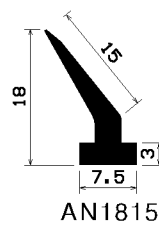
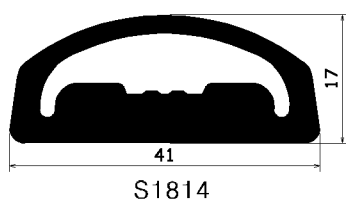
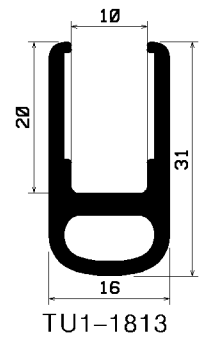
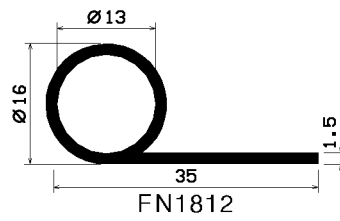
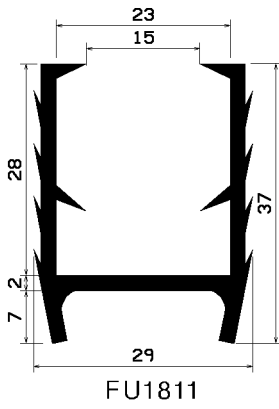
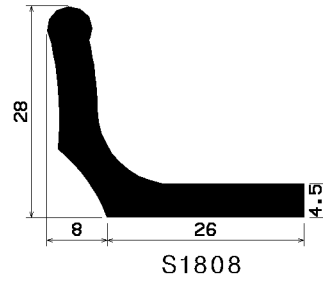
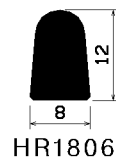
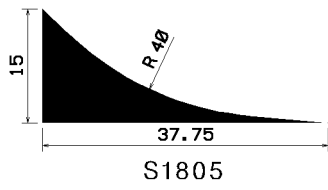
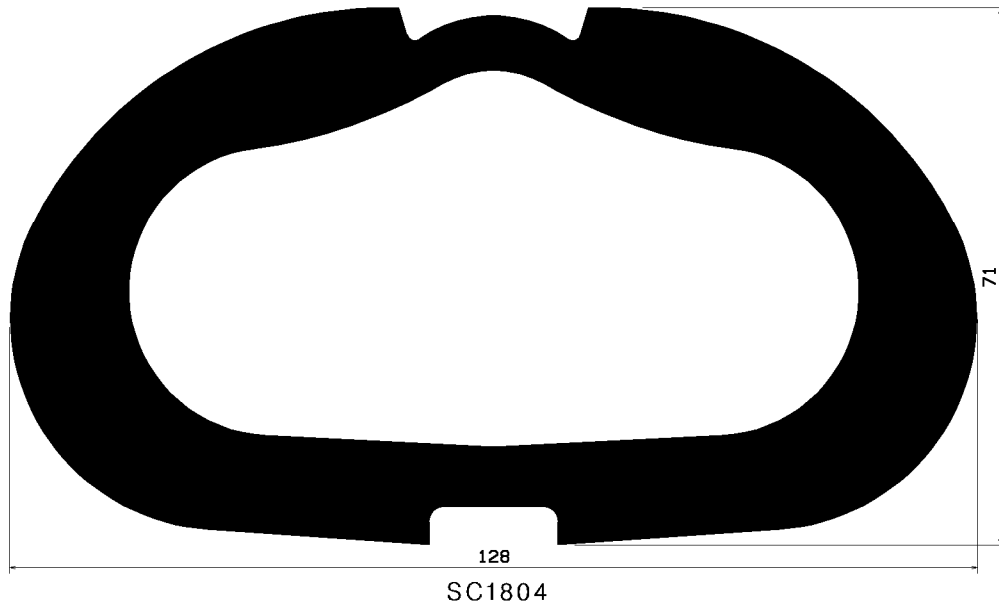

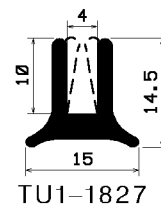
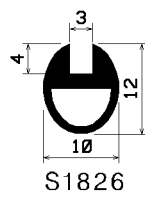
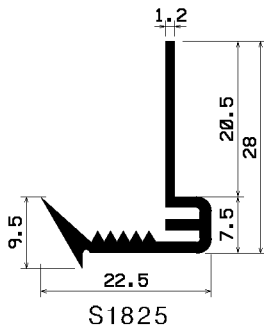
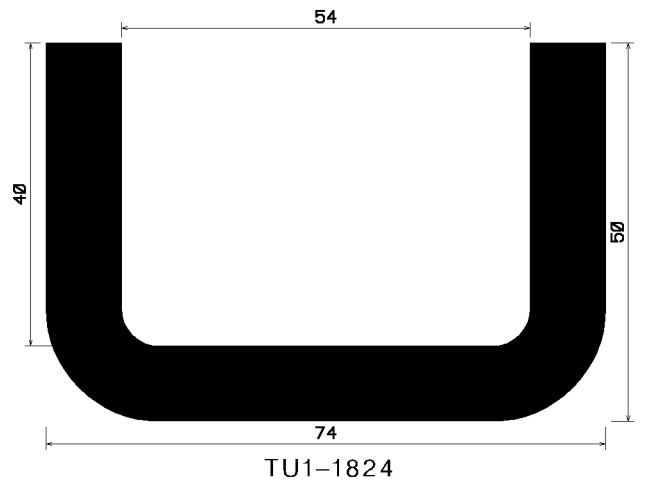
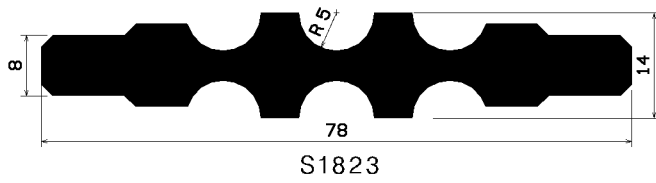
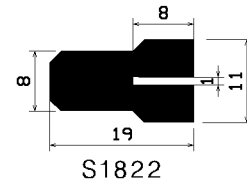
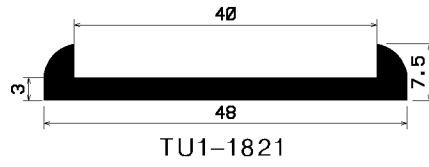
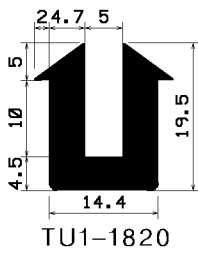
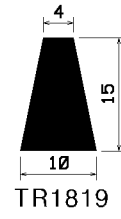
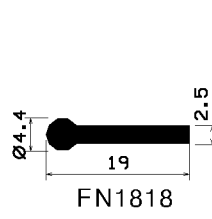
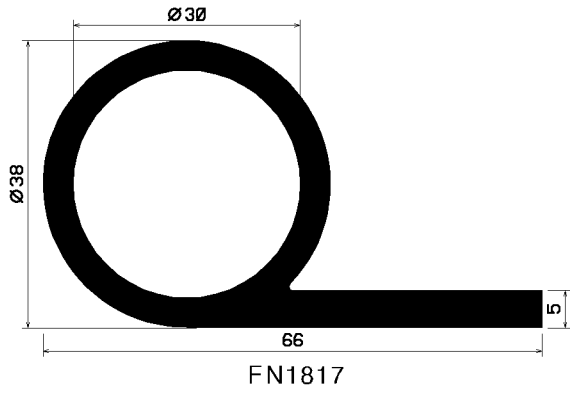

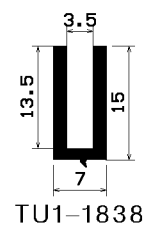
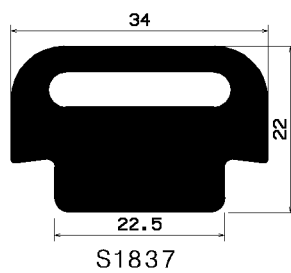
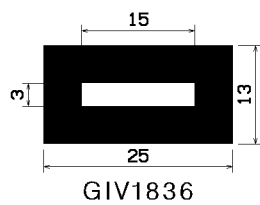
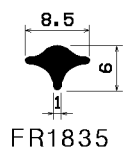
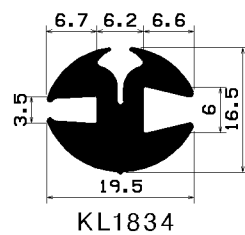
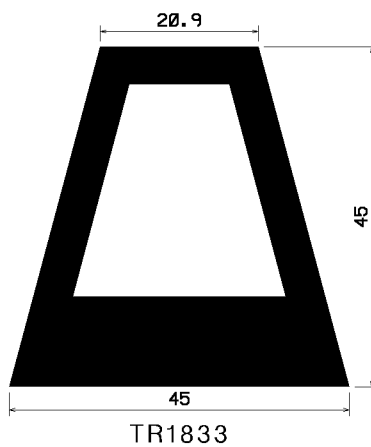
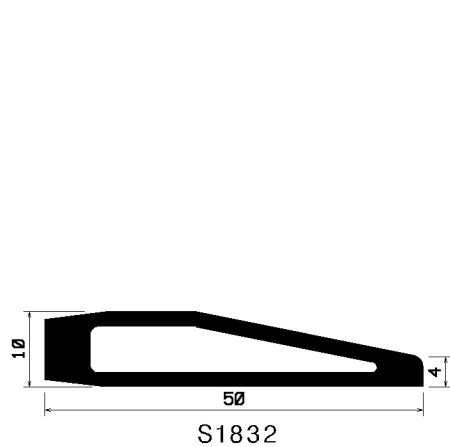
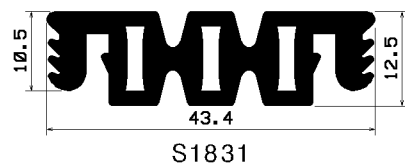
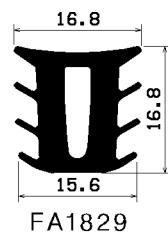
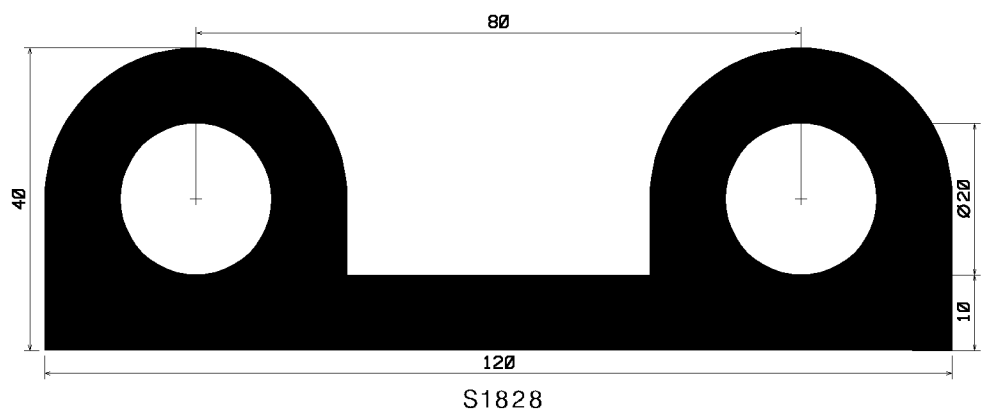

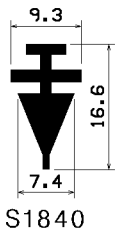

S1840

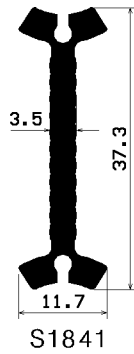

S1841

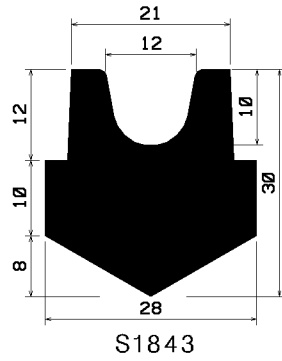

S1843

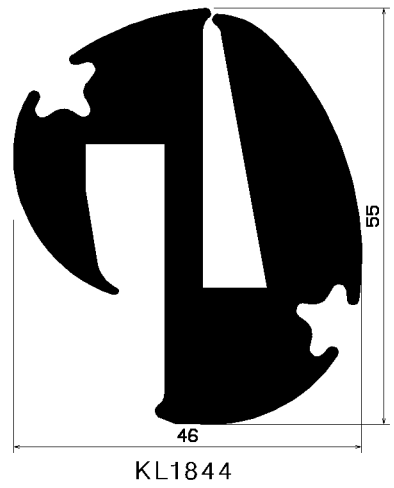

KL1844

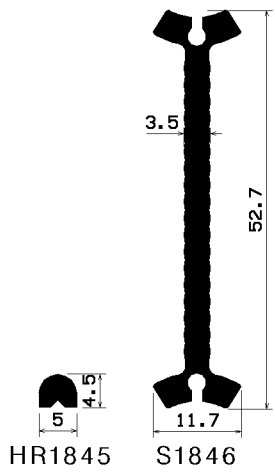

HR1845

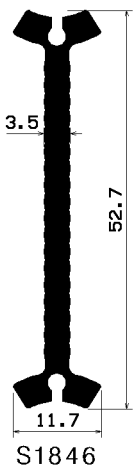

S1846



GIV1847

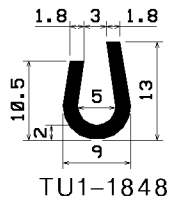

TU1-1848

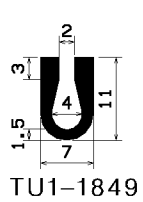

TU1-1849

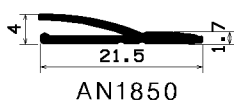

AN1850

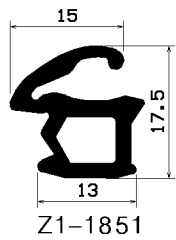

Z1-1851

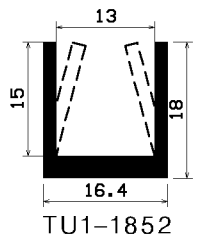

TU1-1852

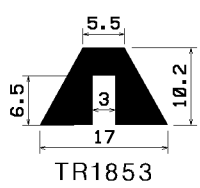

TR1853

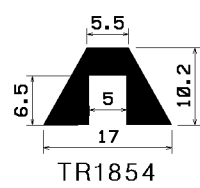

TR1854

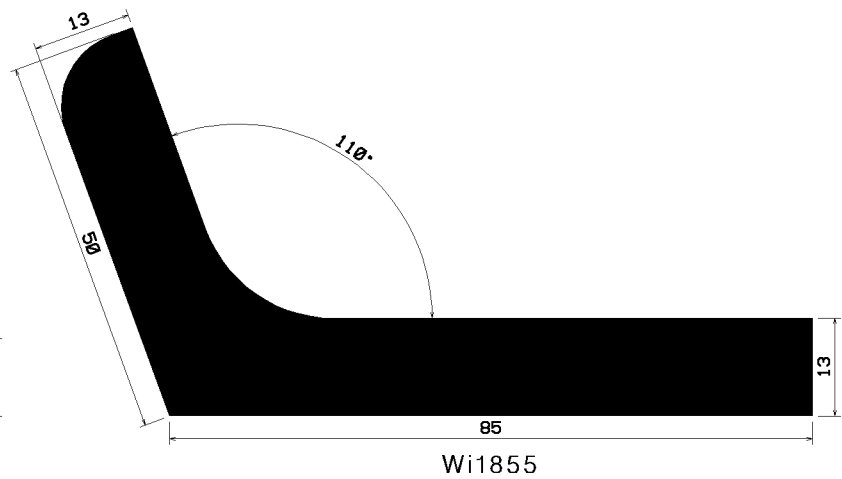

W1855

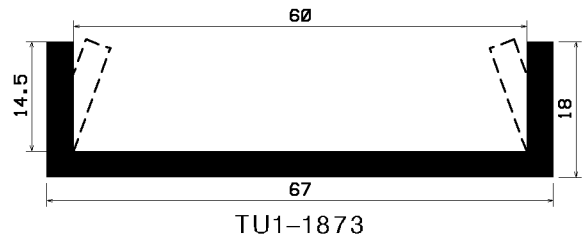
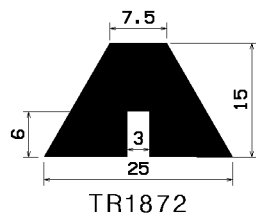
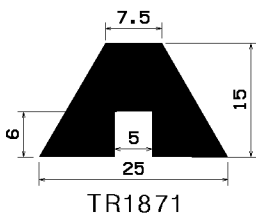
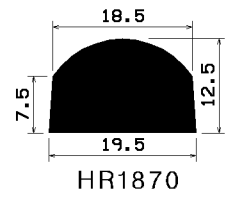
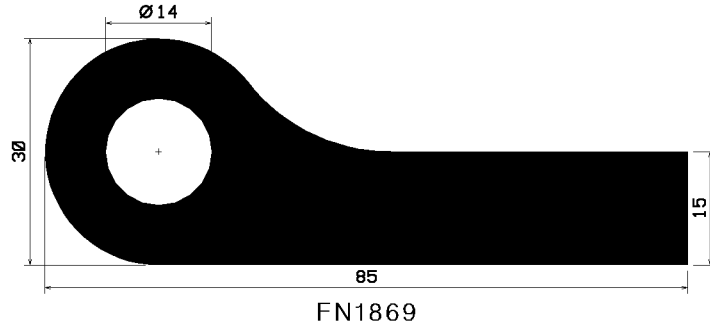
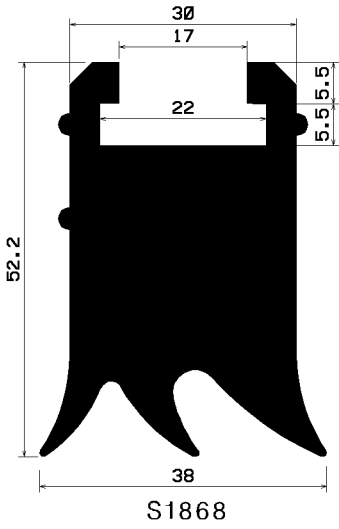
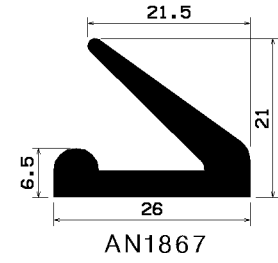
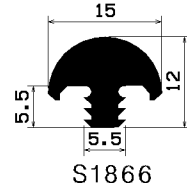
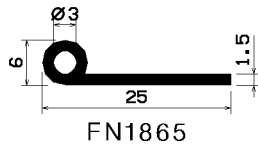
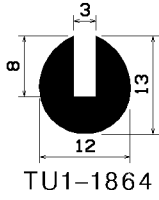
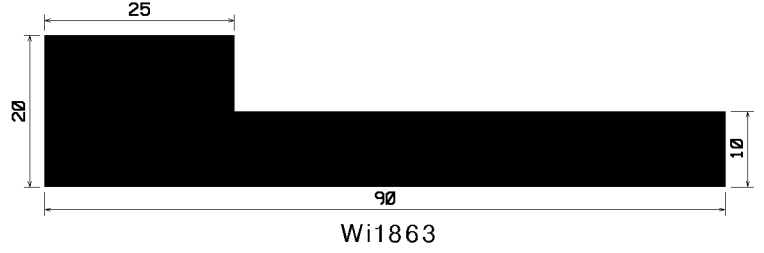
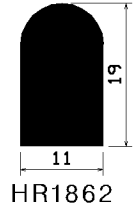
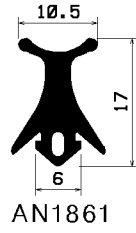
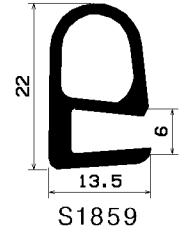
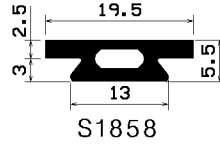
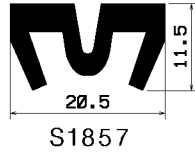
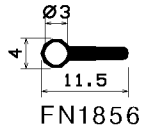
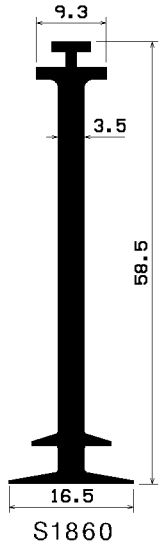

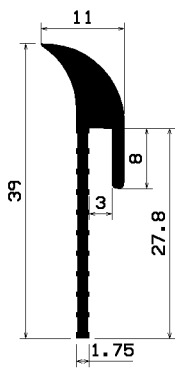

S1875

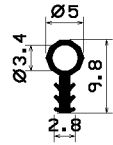

SC1876

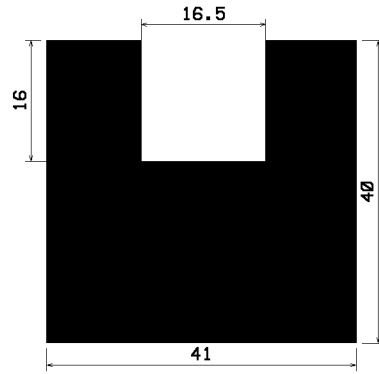

TU1-1877

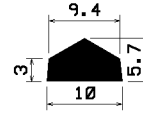

S1878

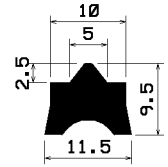

S1879

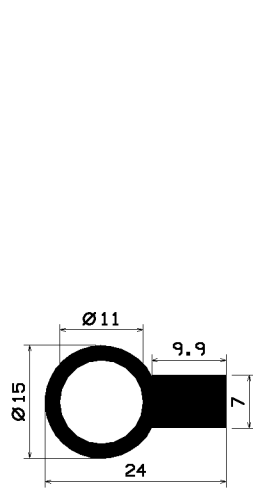

FN1880

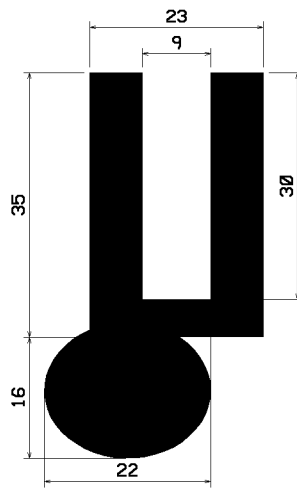

TU1-1881

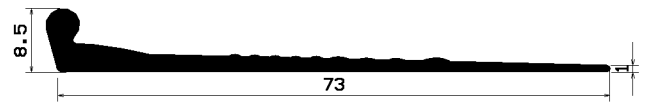

S1882

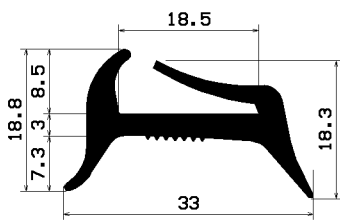

S1883

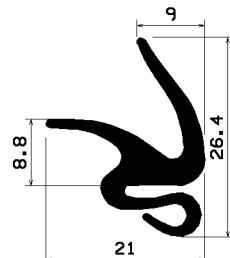

S1884

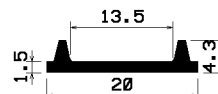

S1885

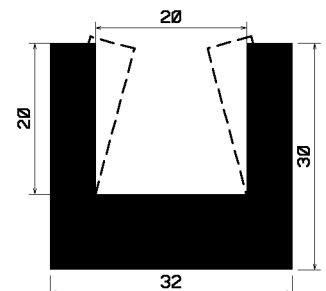

TU1-1886

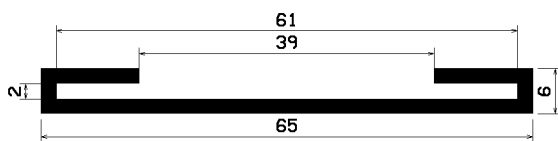

SE1887



S1888

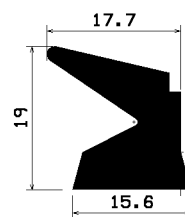

Z1-1889

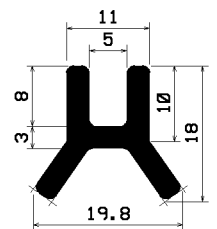

TU1-1890

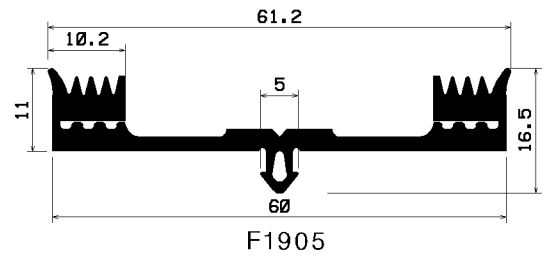
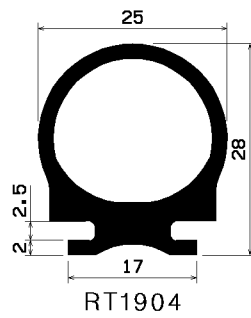
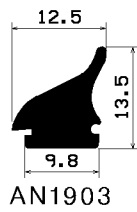
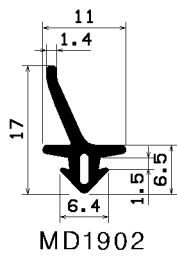
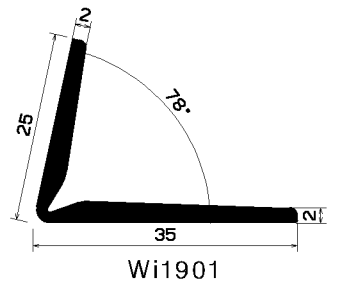
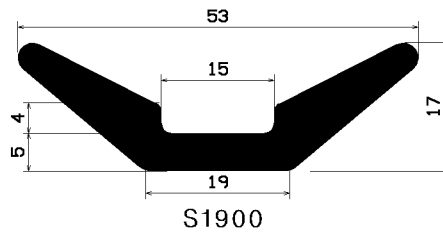
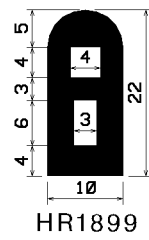
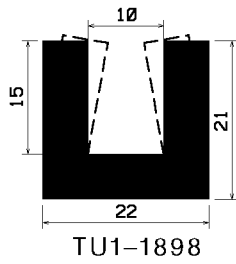
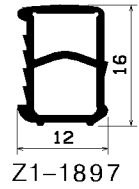
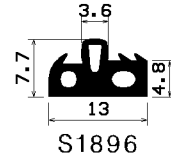
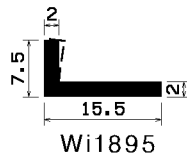
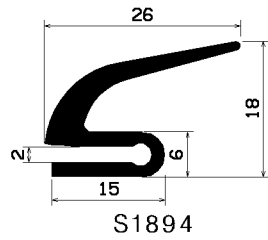
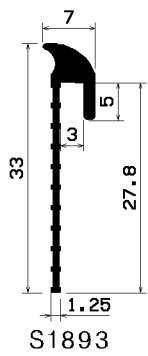
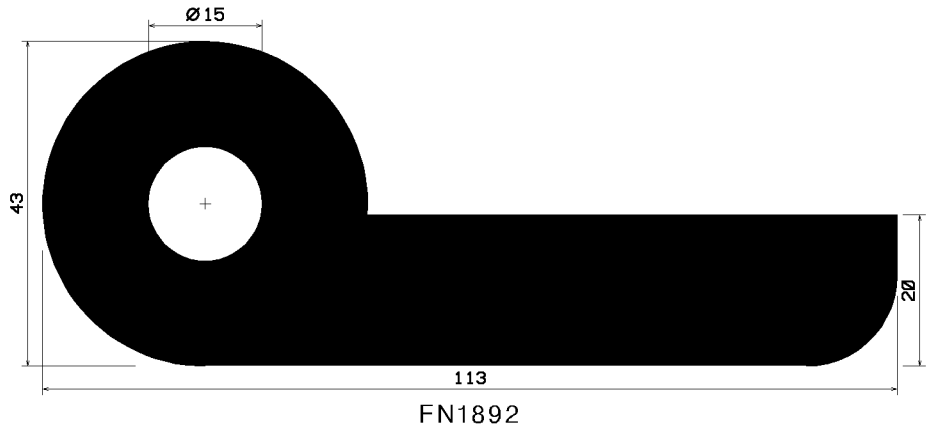
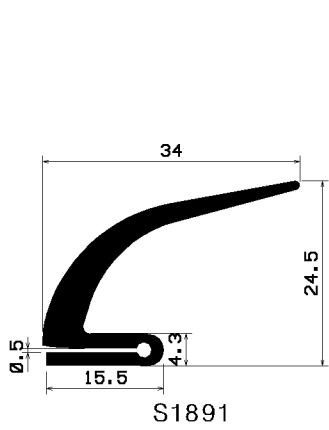

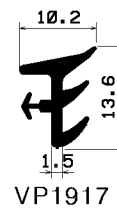
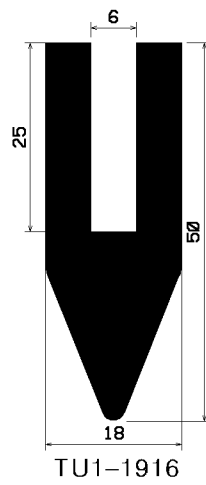
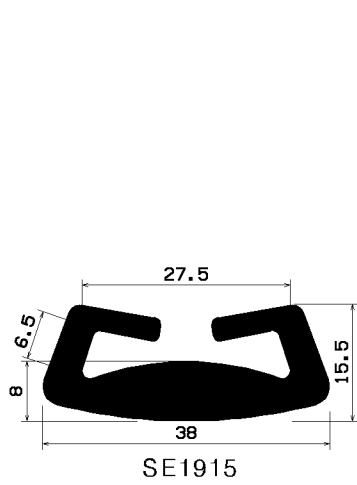
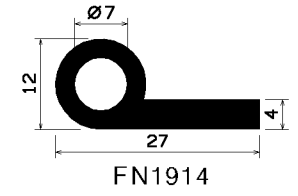
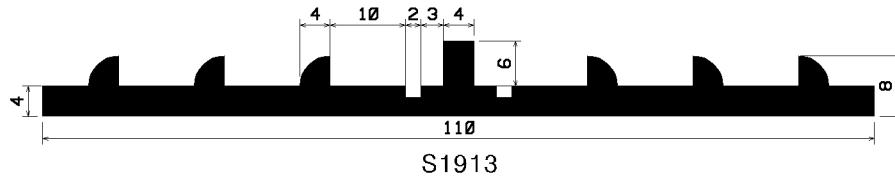
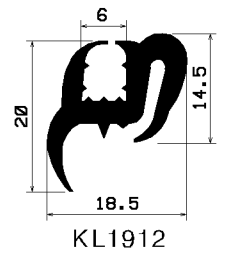
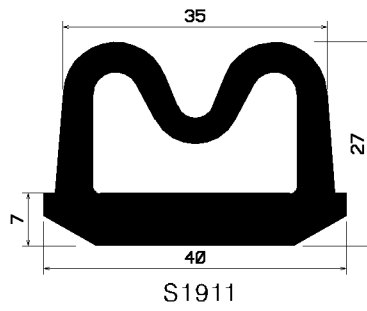
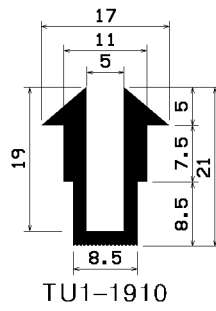
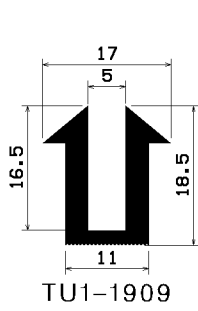
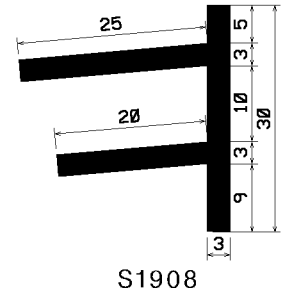
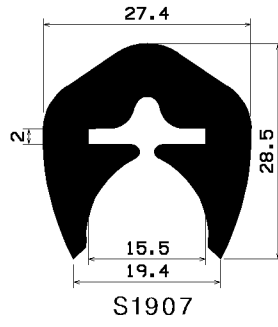
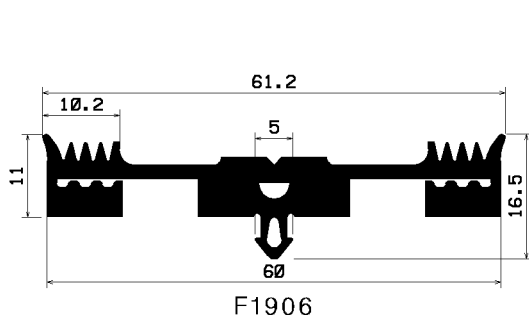

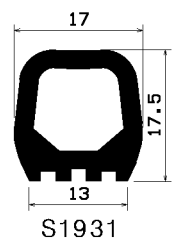
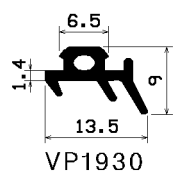
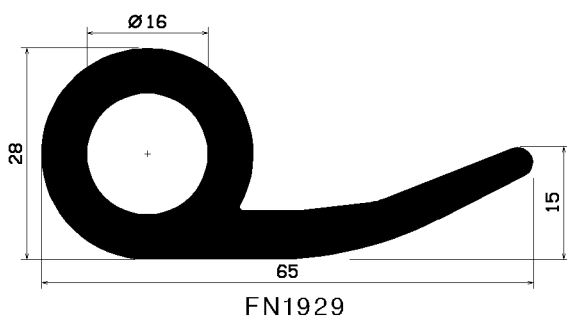
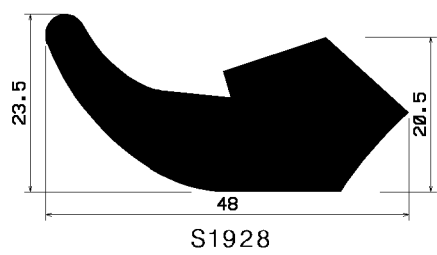
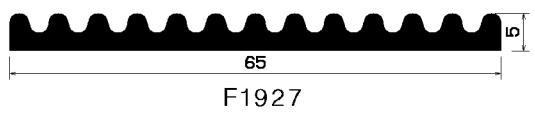
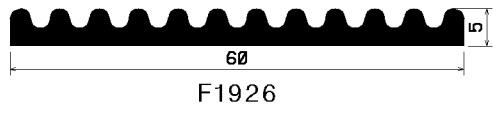
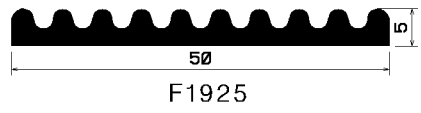
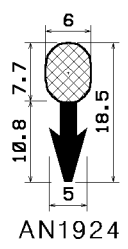
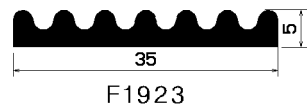
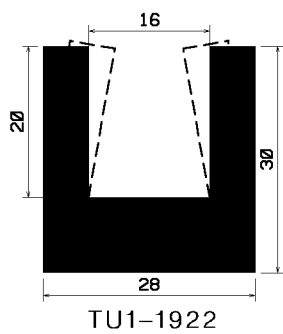
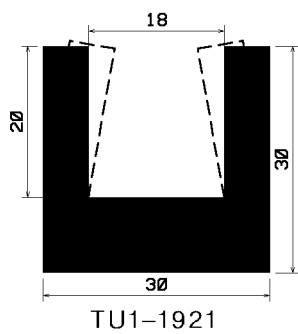
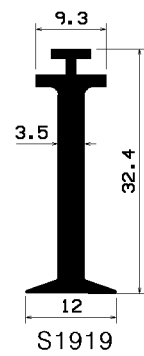
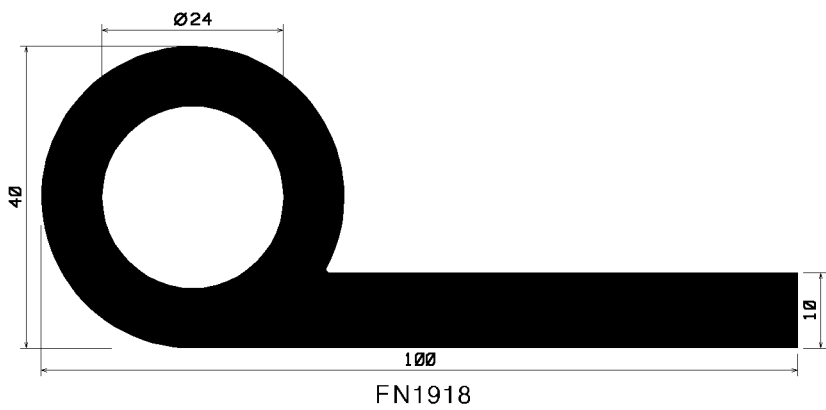

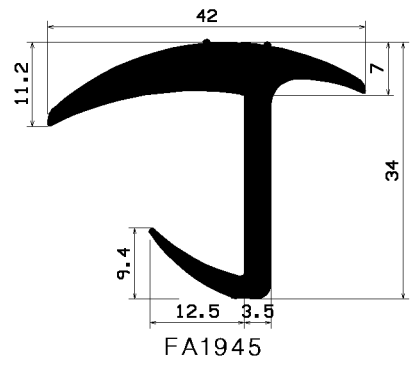
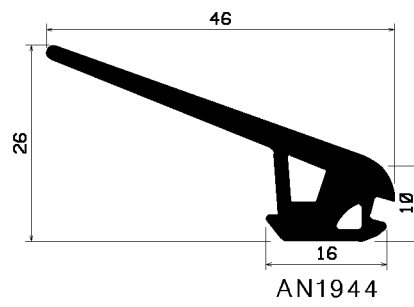
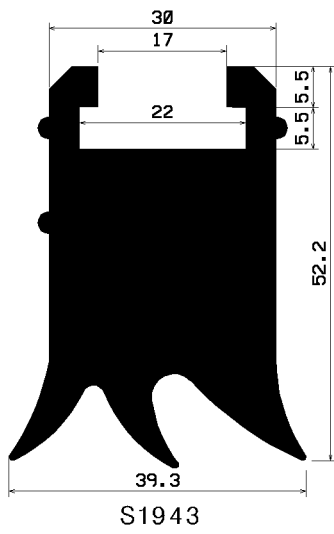
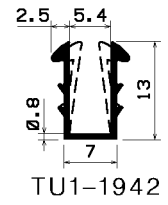
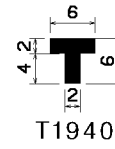
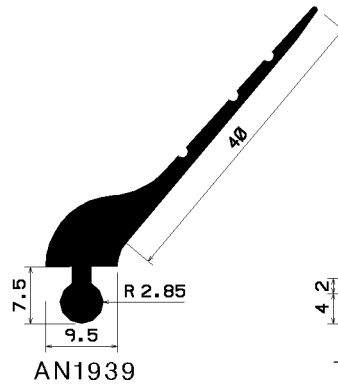
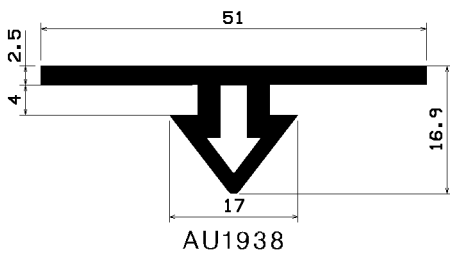
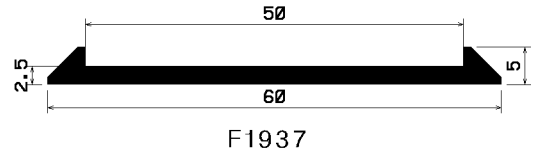
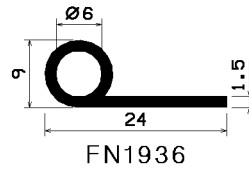
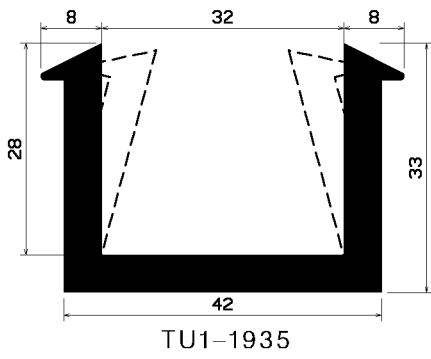
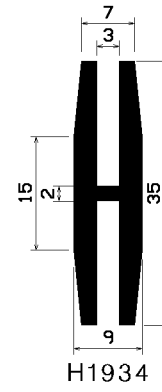
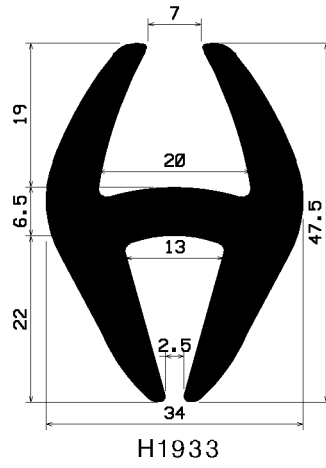
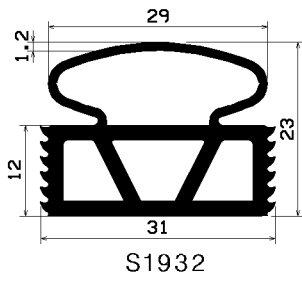

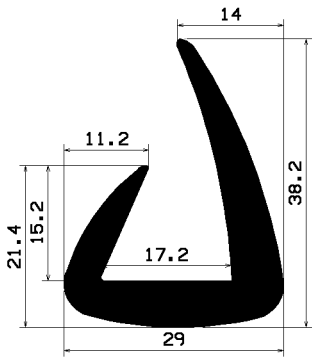

TU1-1946

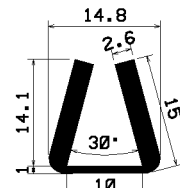

TU1-1954

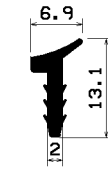

VP1955

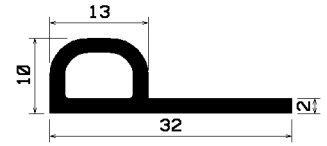

FN1956

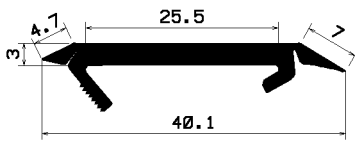

VP1959

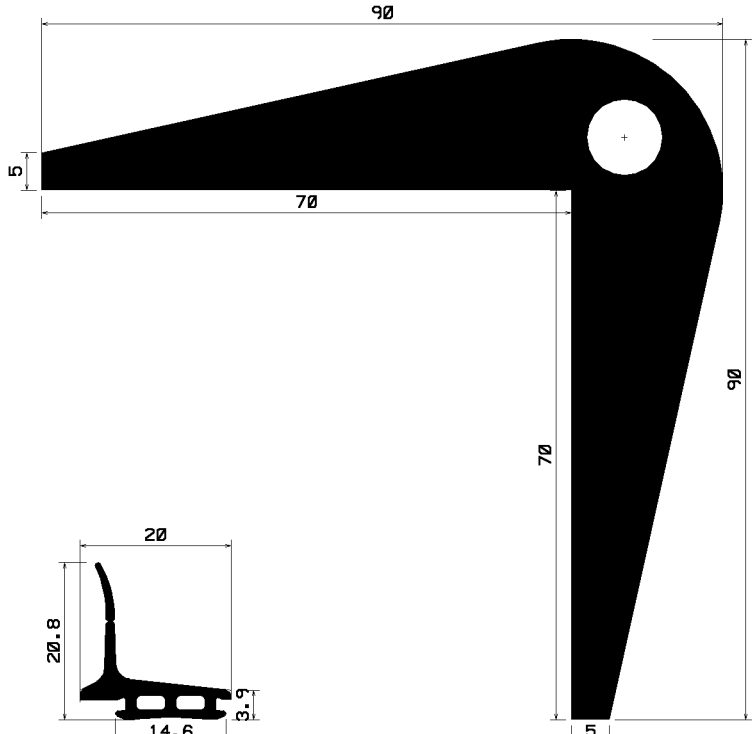

Wi1963

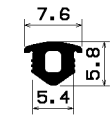

AN1960

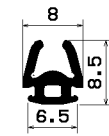

AN1961

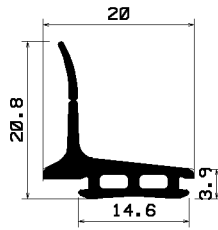

AN1962

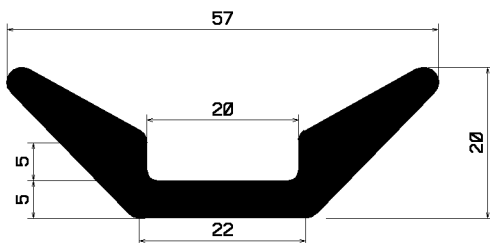

S1964

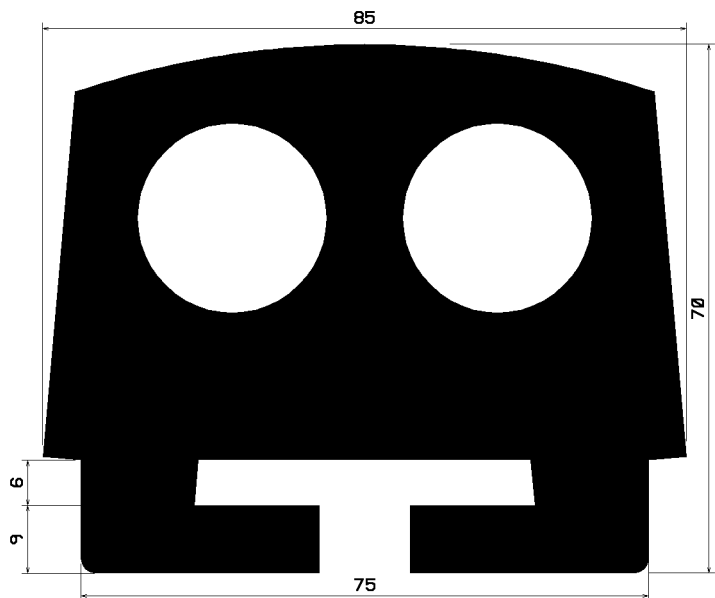

S1965

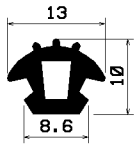

AN1966

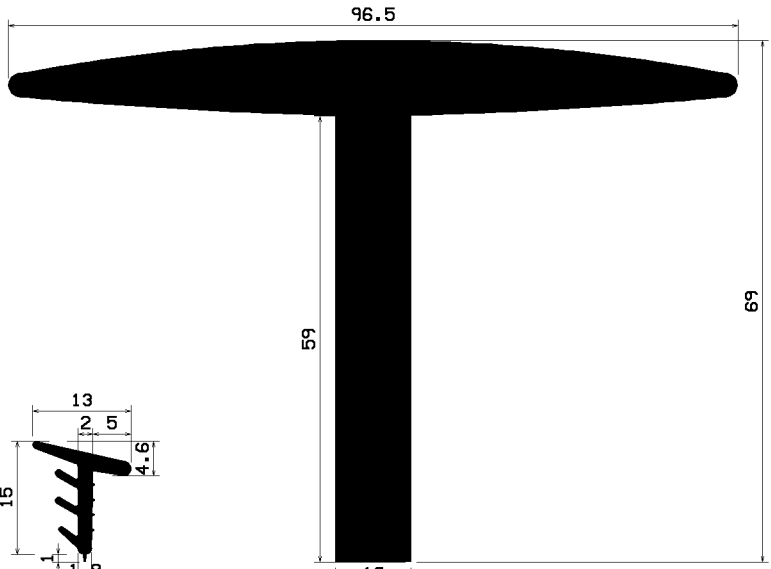

T1970

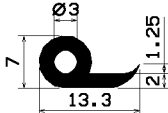

FN1967

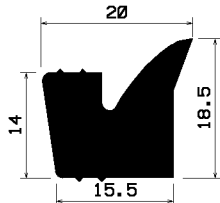

S1968

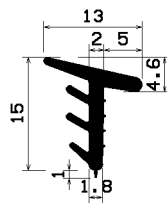

VP1969

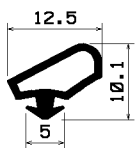

AN1971

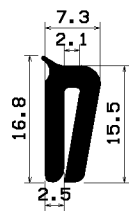

S1972

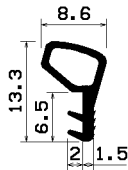

SC1973

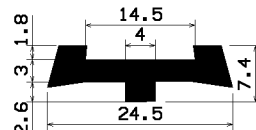

S1974

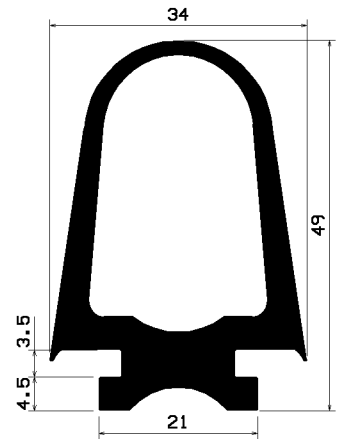

RT1975

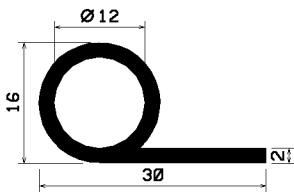

FN1976

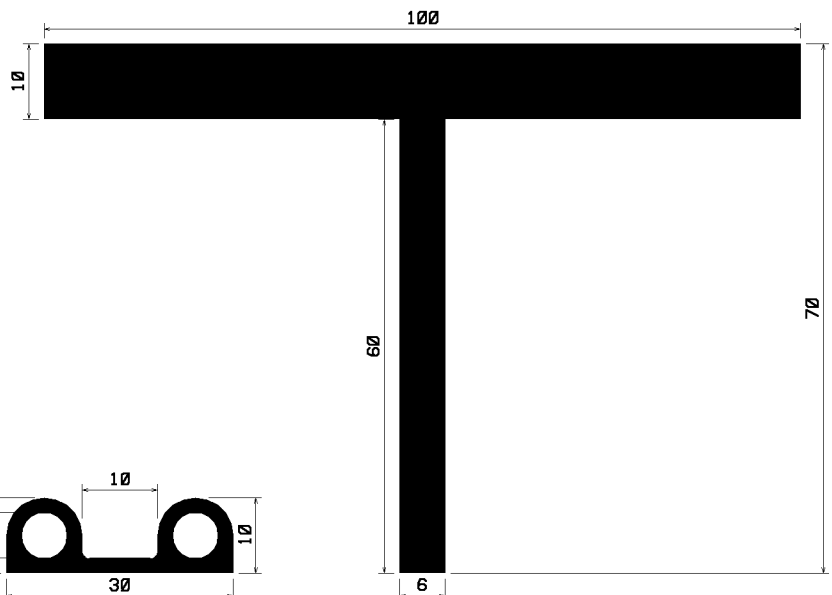

T1981

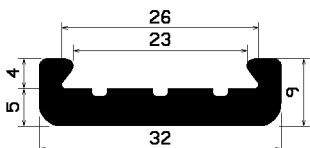

S1979

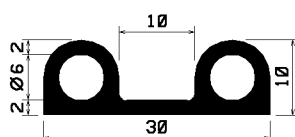

S1980

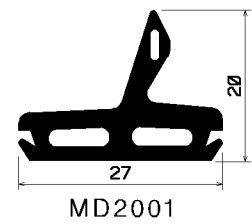
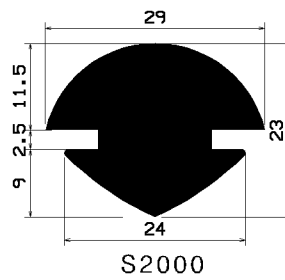
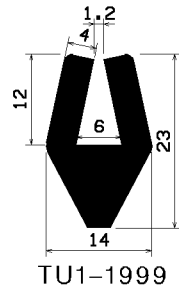
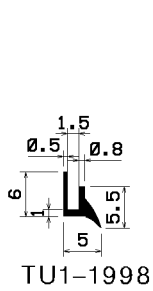
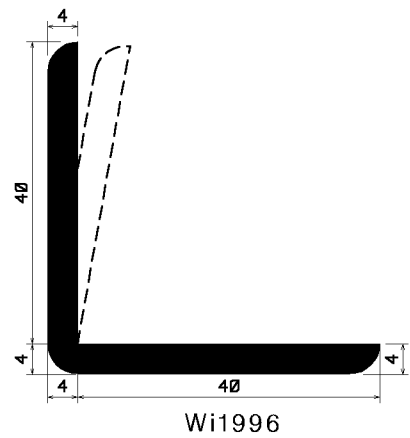
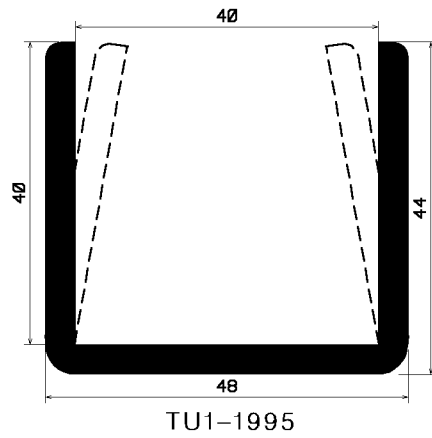
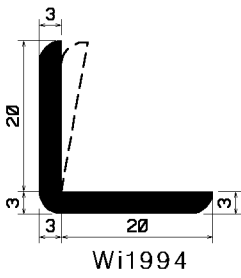
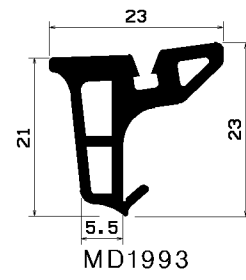
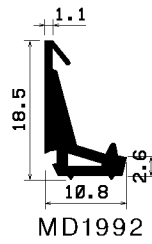
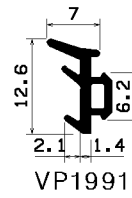
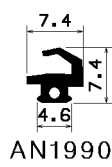
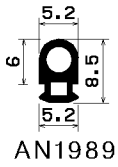
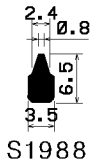
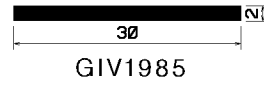
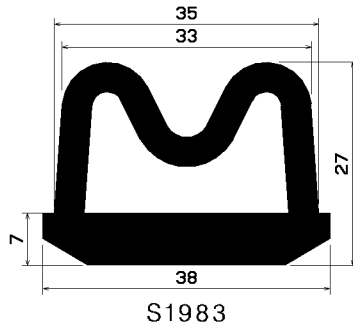
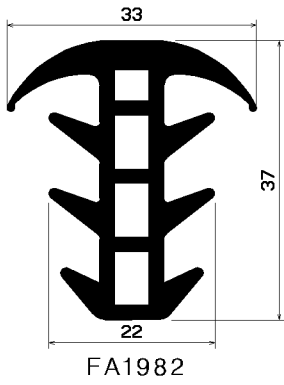

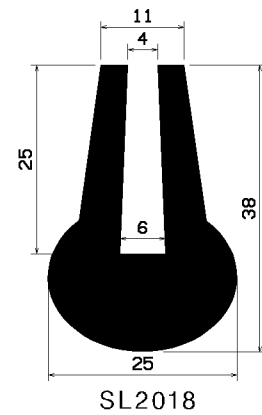
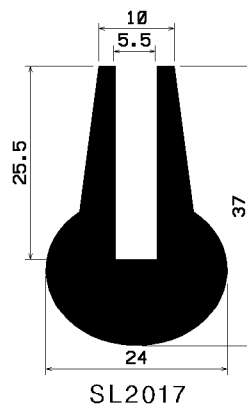
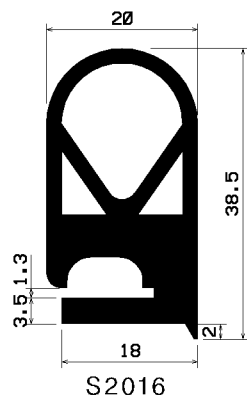
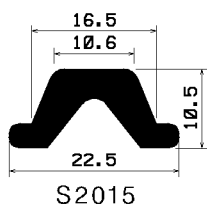
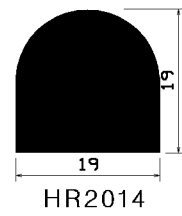
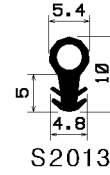
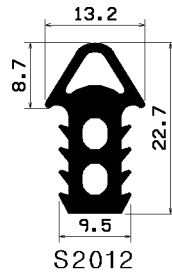
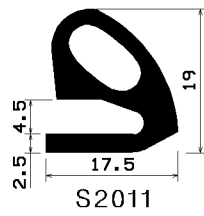
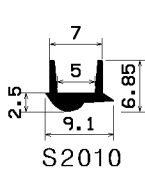
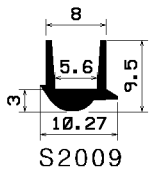
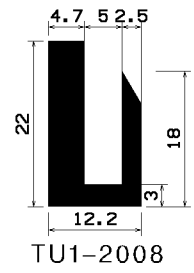
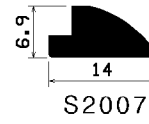
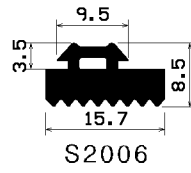
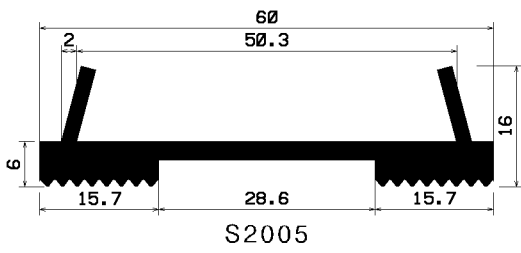
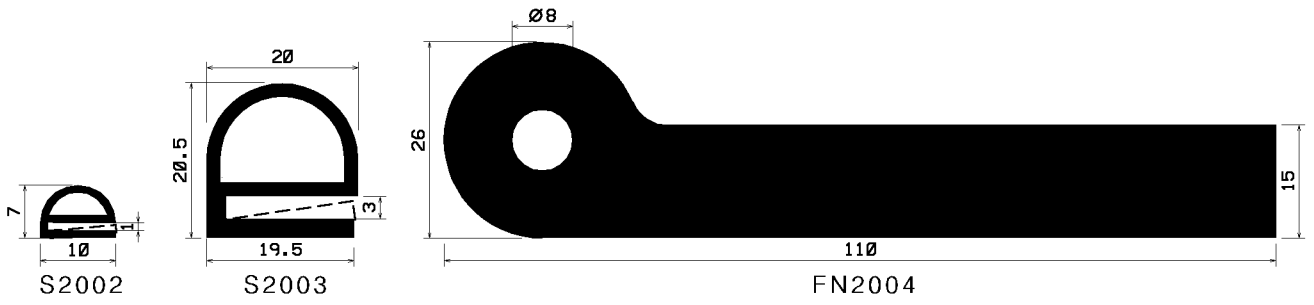

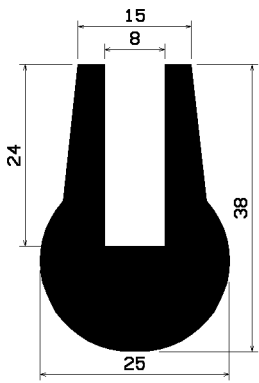

SL2019

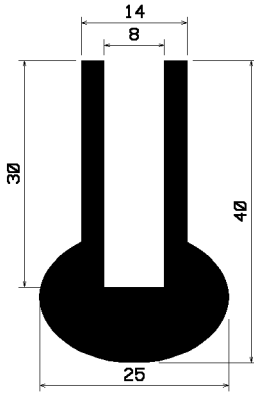

SL2020

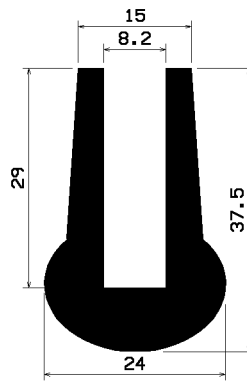

SL2021

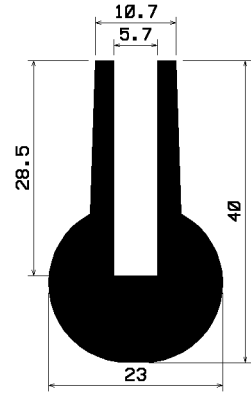

SL2022

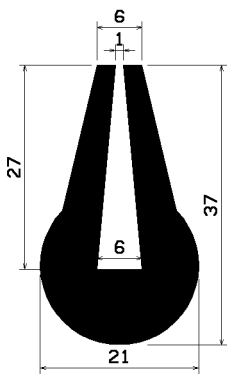

SL2023

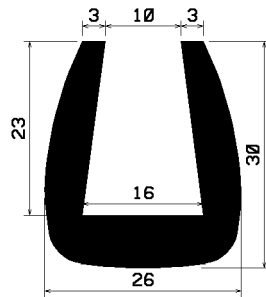

SL2024

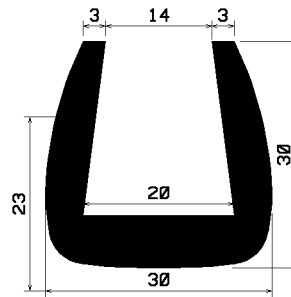

SL2025

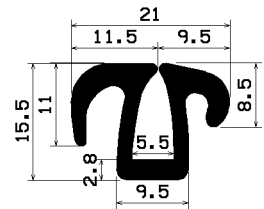

TU1-2026

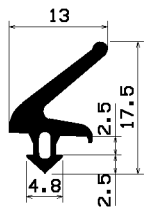

AN2027

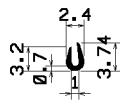

TU1-2028

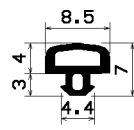

SC2029

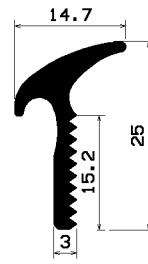

S2030

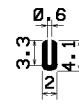

TU1-2031

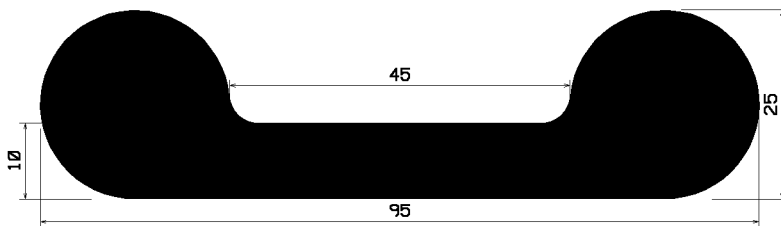

S2032

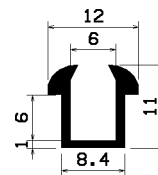

TU1-2033

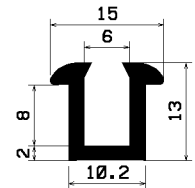

TU1-2034

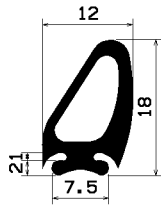

RT2036

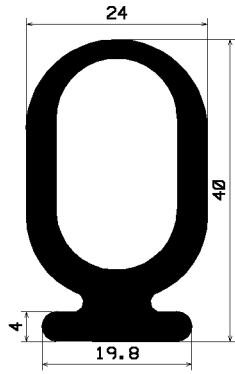

RT2037

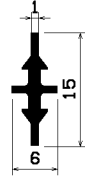

S2038

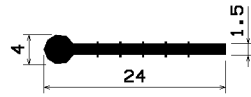

FN2039

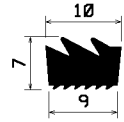

S2040

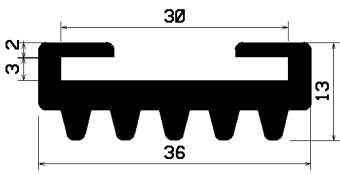

SE2041

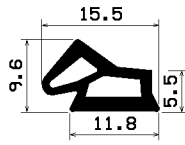

S2042

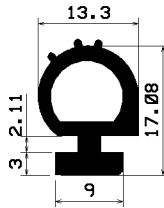

RT2044

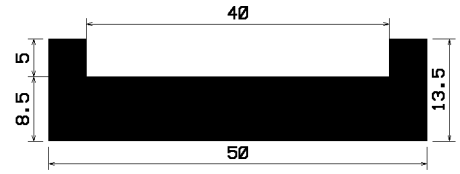

TU1-2045

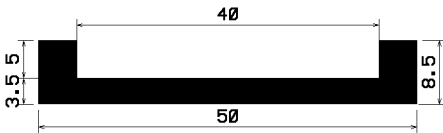

TU1-2046

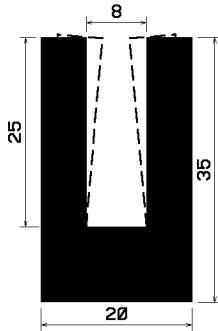

TU1-2047

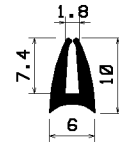

TU1-2048

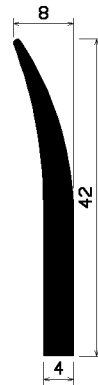

S2049

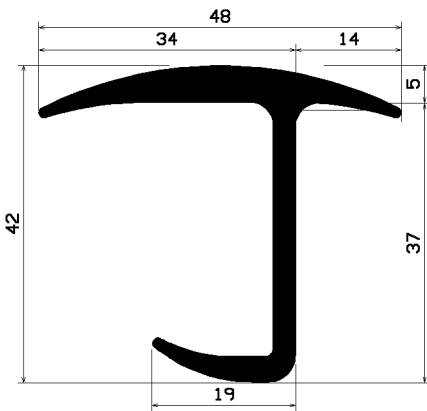

FA2050

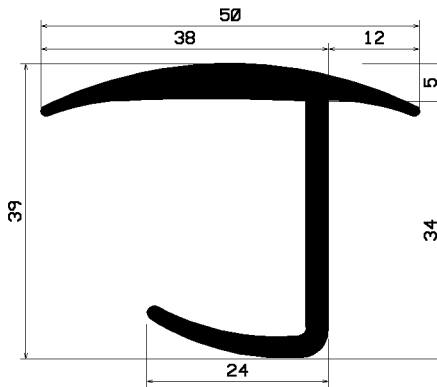

FA2051

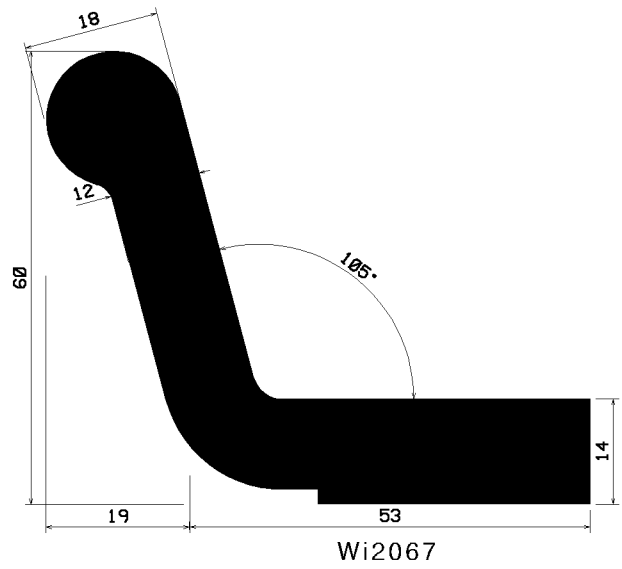
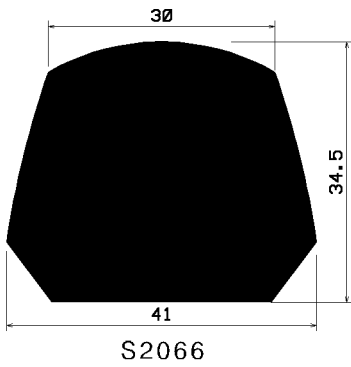
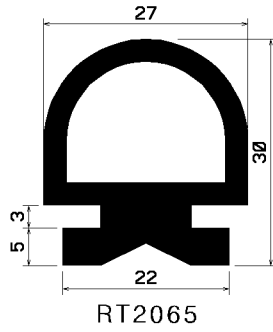
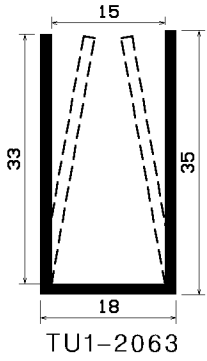
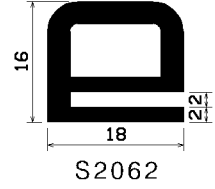
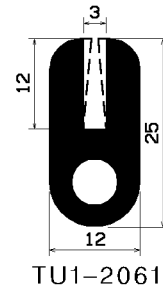
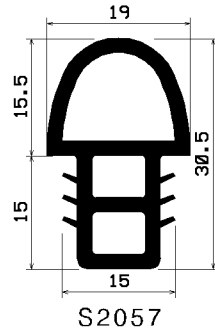
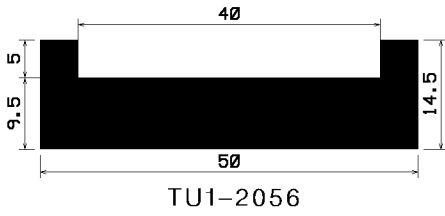
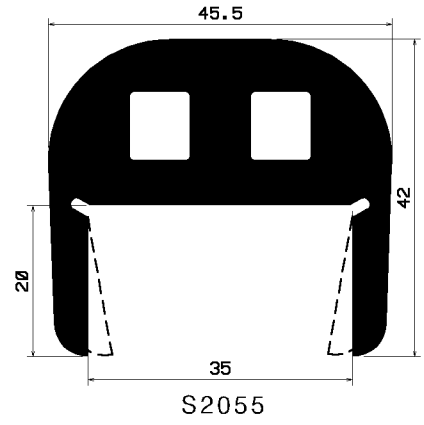
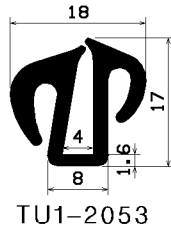
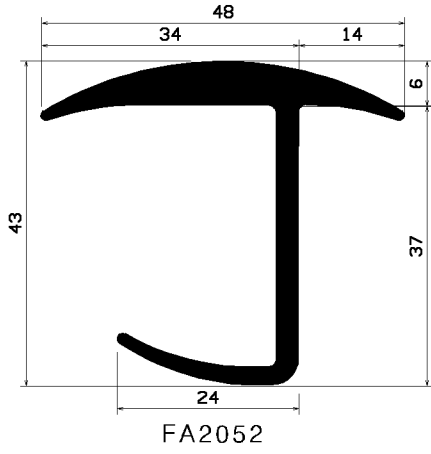

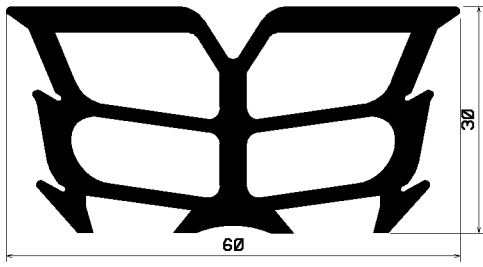

FA2068



S2069

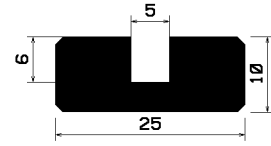

TU1-2070

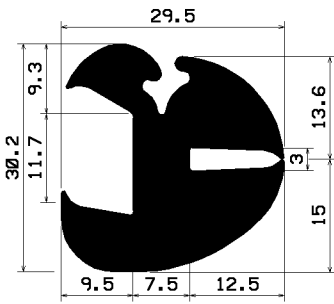

KL2071

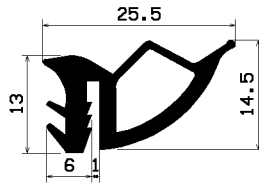

S2072

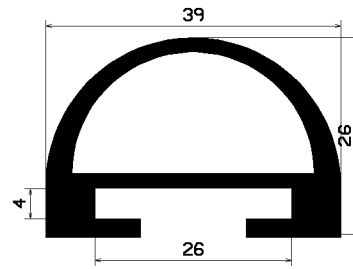

S2073

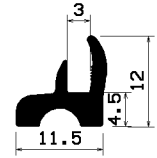

S2074

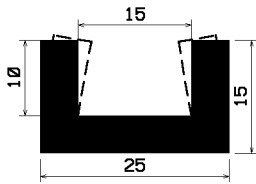

TU1-2075

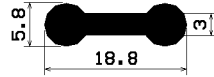

S2076

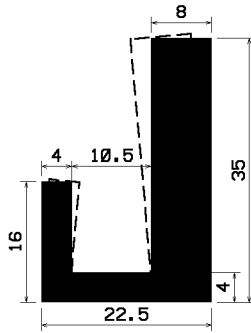

TU1-2077

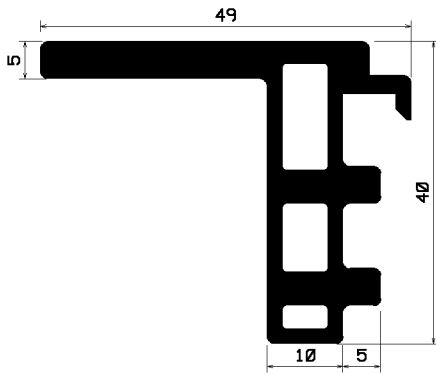

S2079

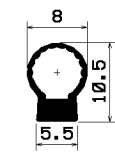

SC2080

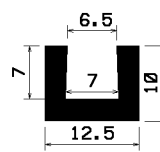

TU1-2081

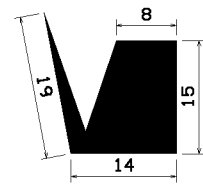

S2083

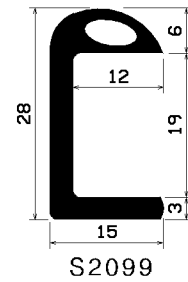
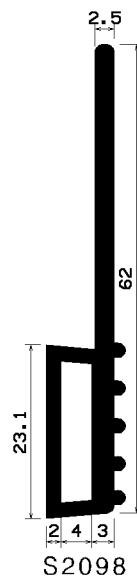
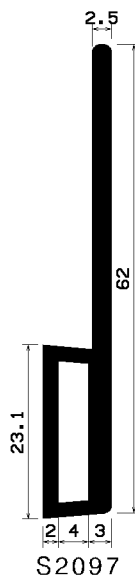
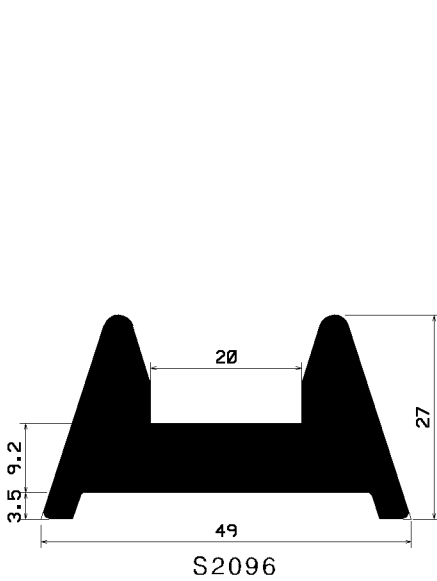
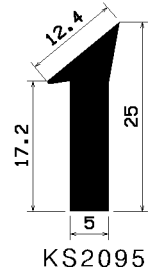
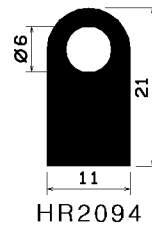
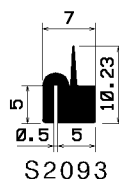
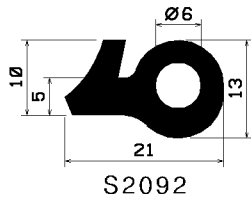
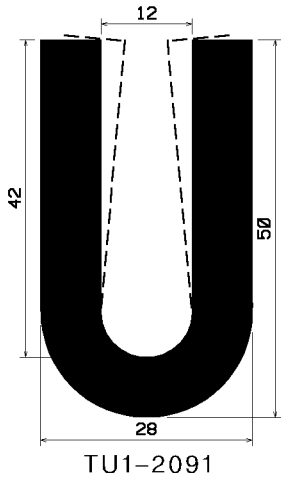
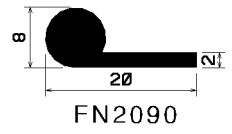
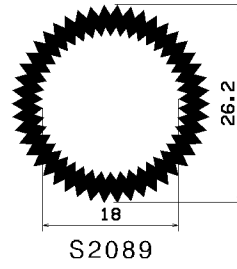
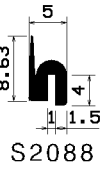
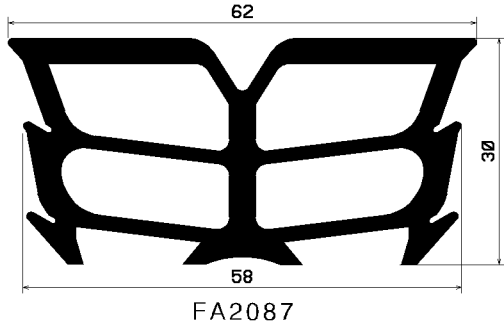
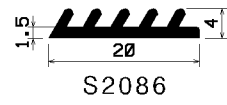
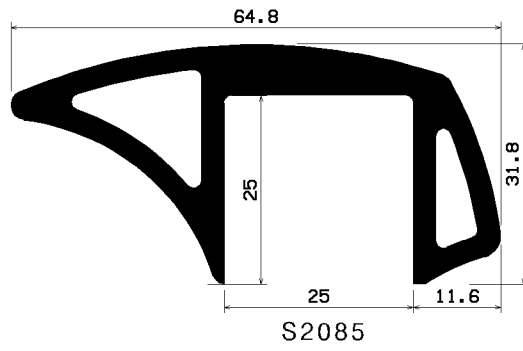
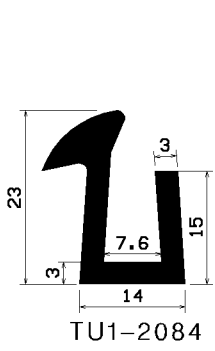

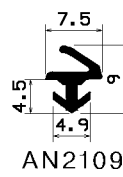
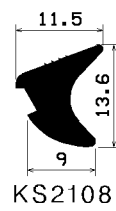
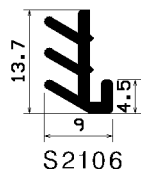
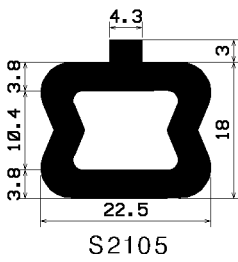
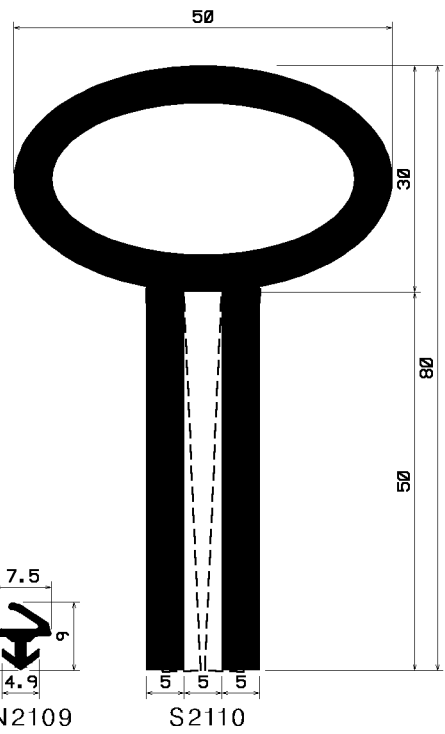
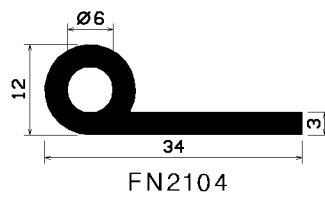
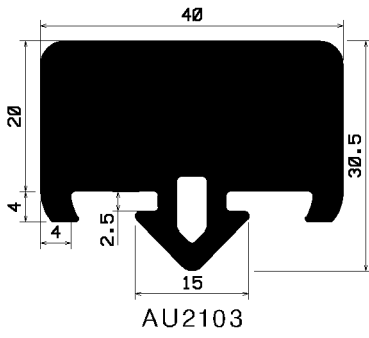
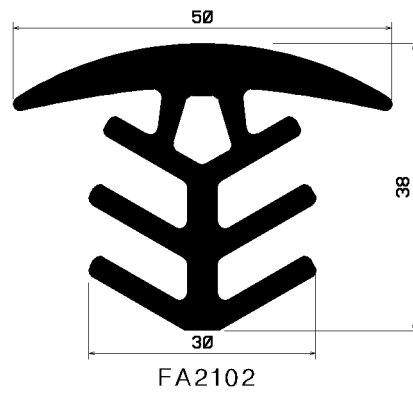
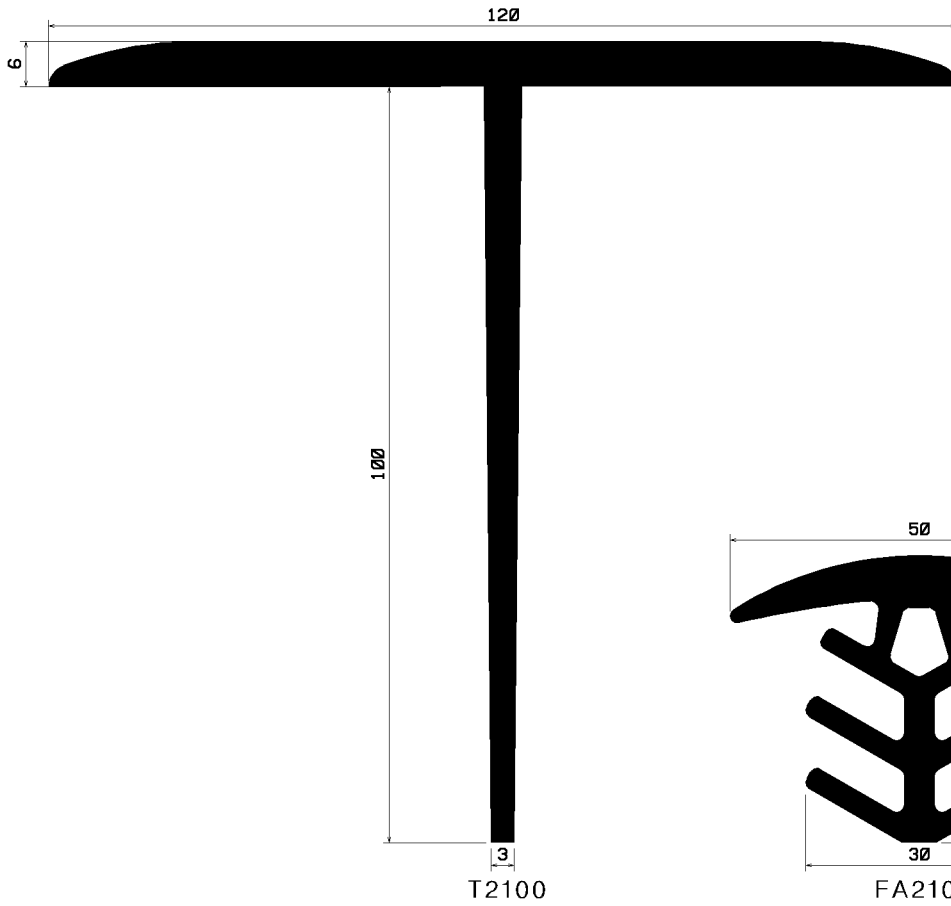

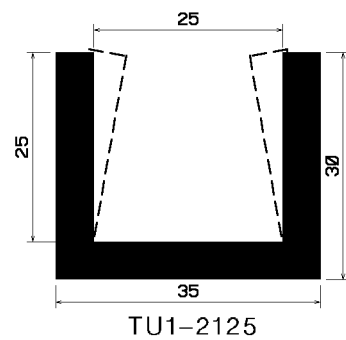
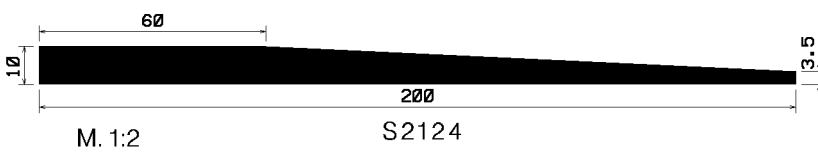
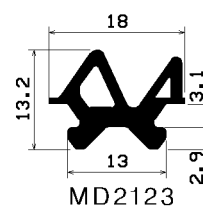
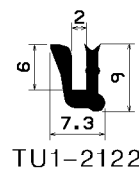
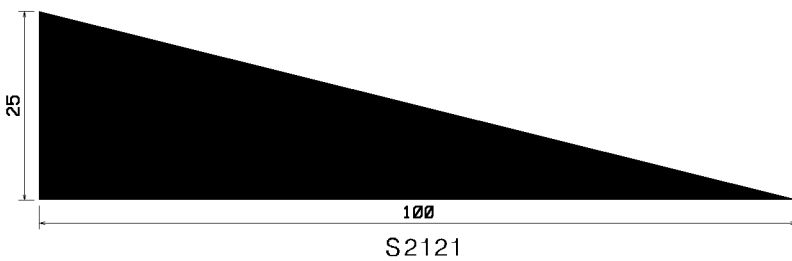
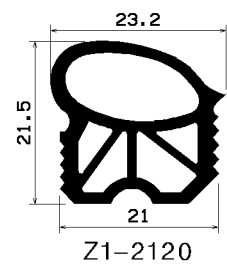
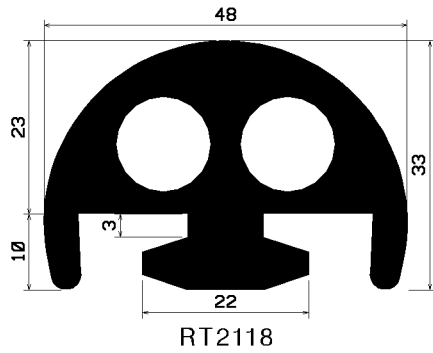
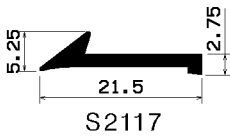
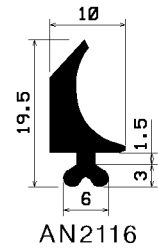
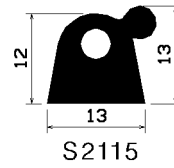
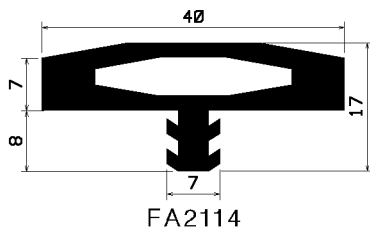
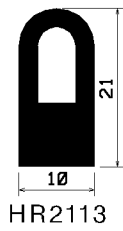
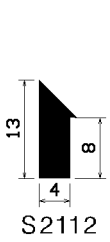

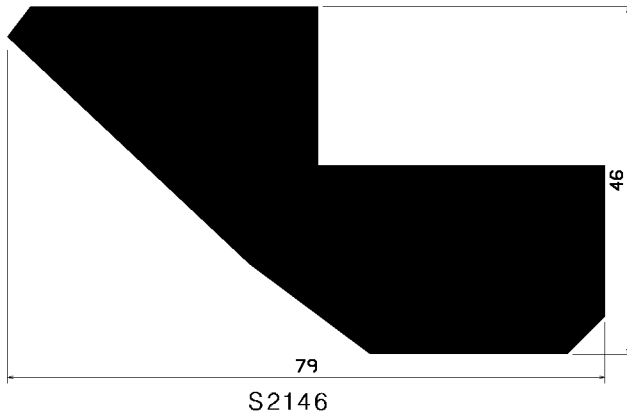
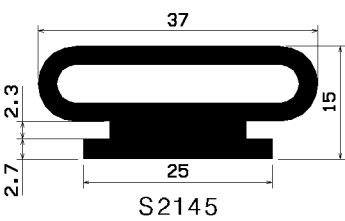
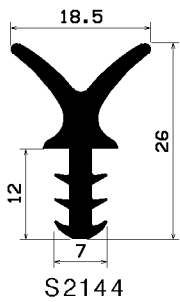
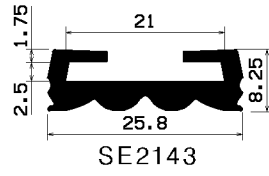
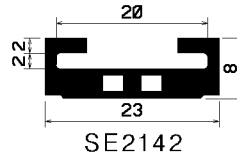
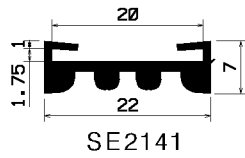
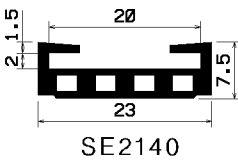
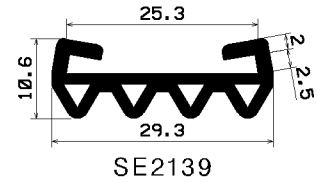
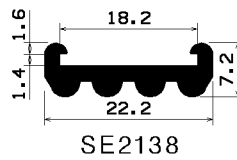
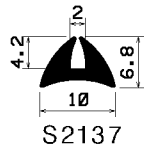
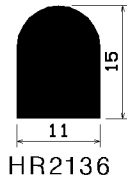
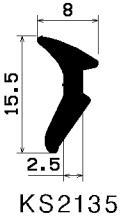
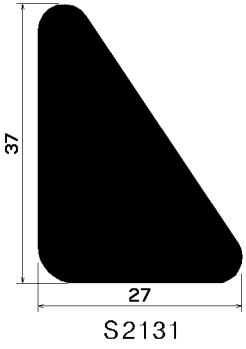
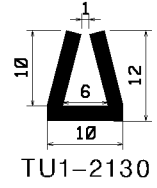
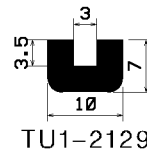
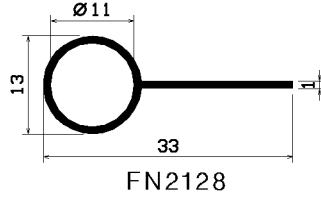
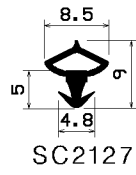
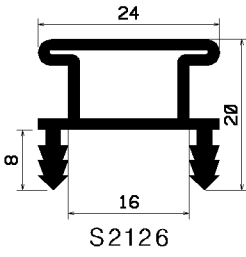

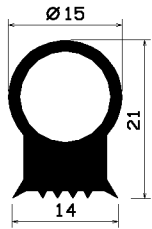

S2147

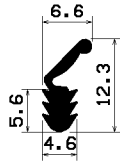

AN2148

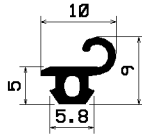

AN2149

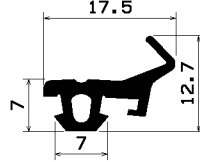

AN2150

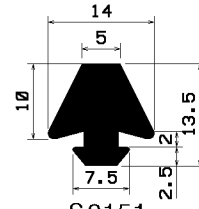

S2151

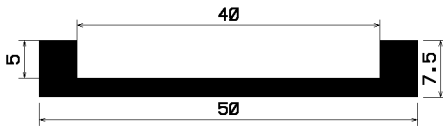

TU1-2152

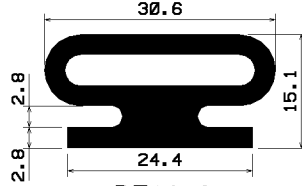

RT2153

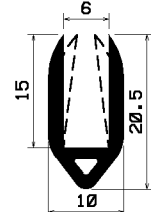

TU1-2154

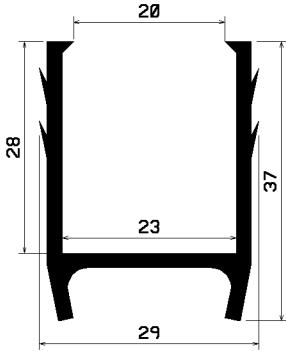

FU2155

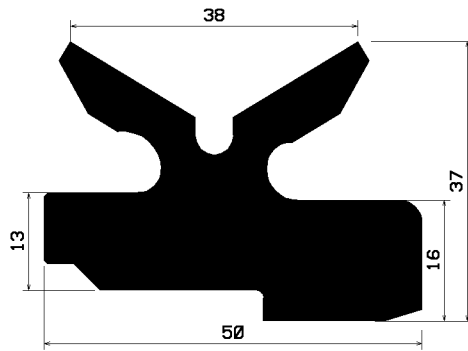

S2156

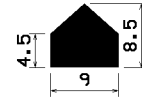

S2157

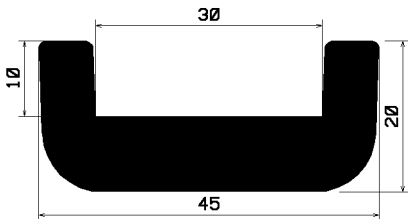

TU1-2158

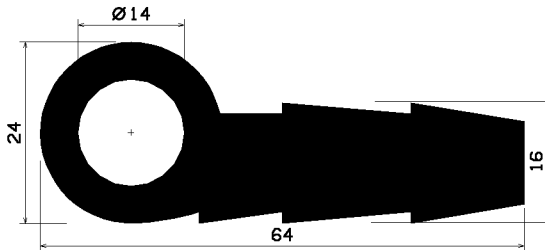

FN2159

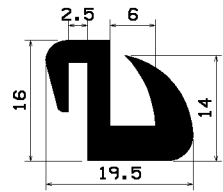

KL2162

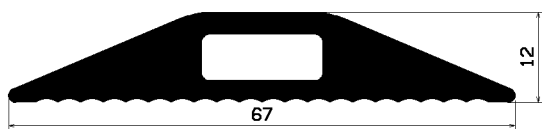

S2163

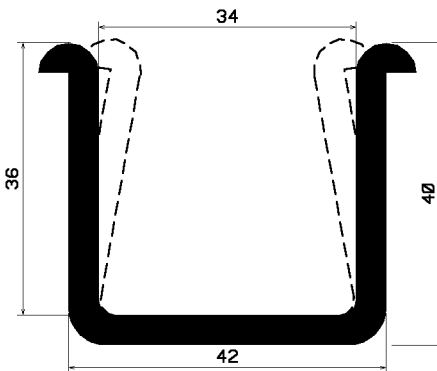

TU1-2164

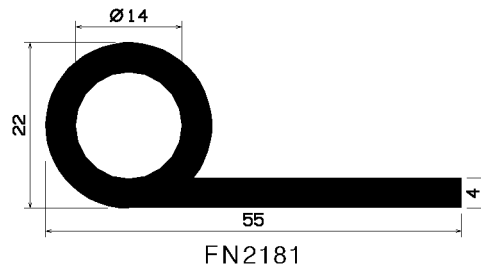
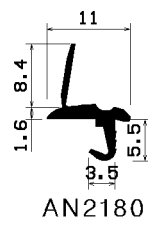
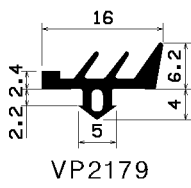
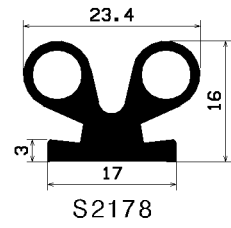
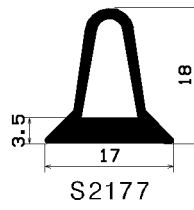
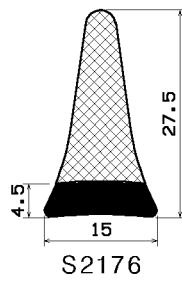
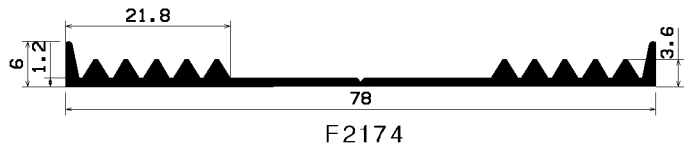
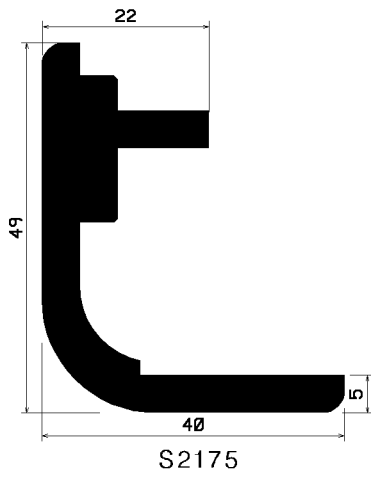
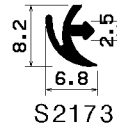
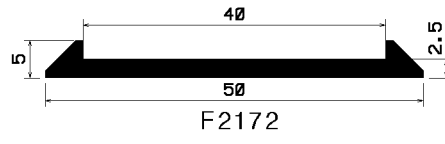
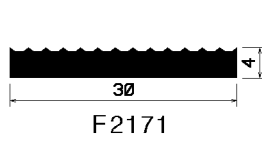
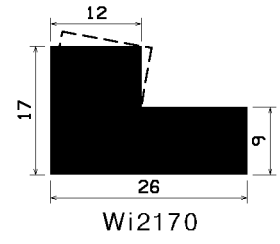
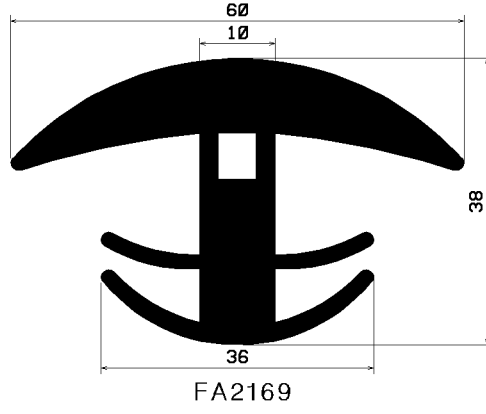
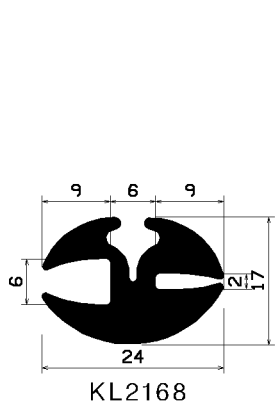
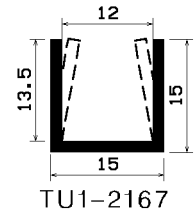
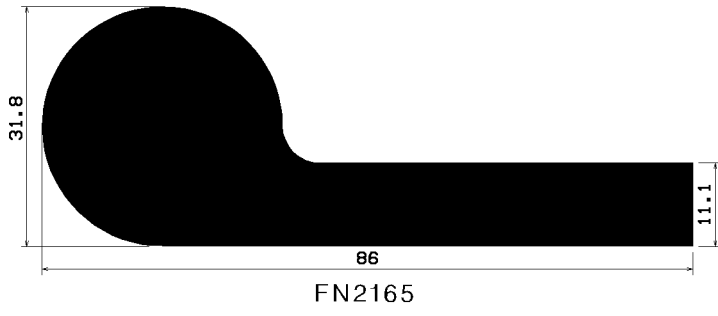

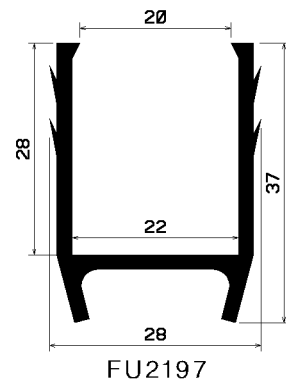
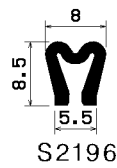
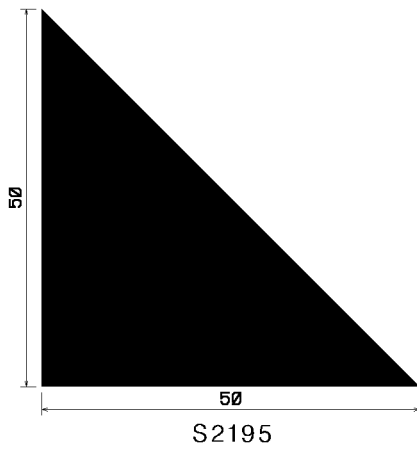
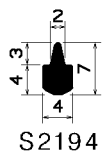
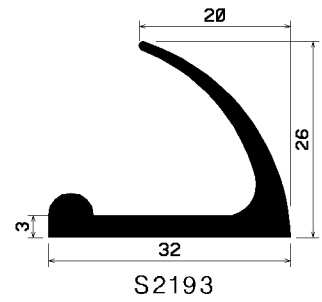
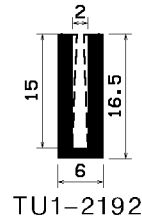
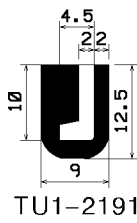
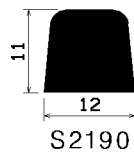
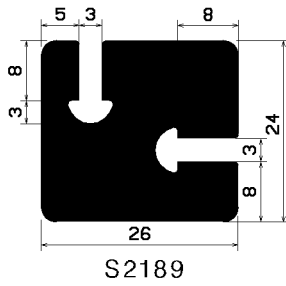
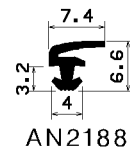
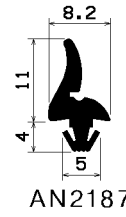
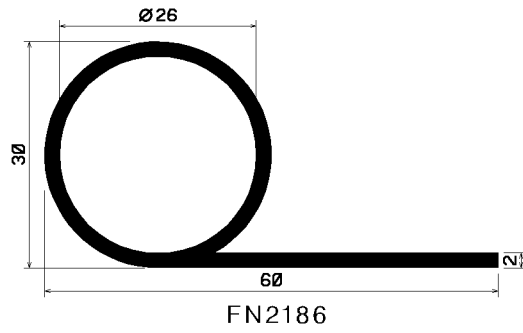
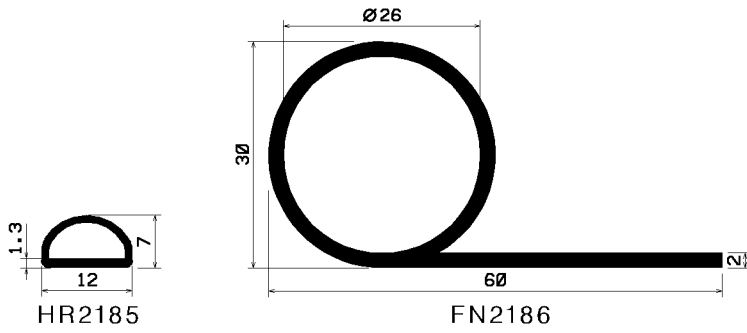
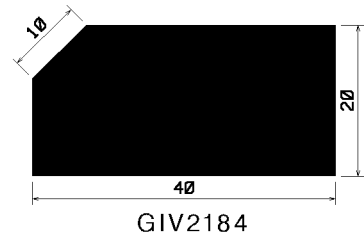
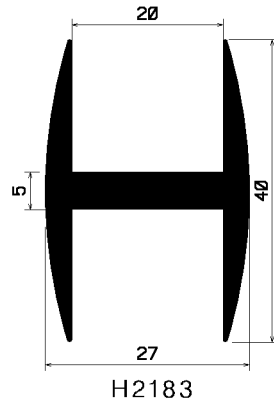
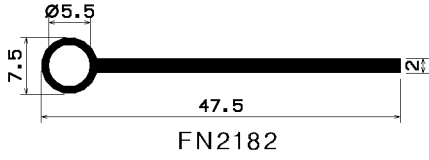

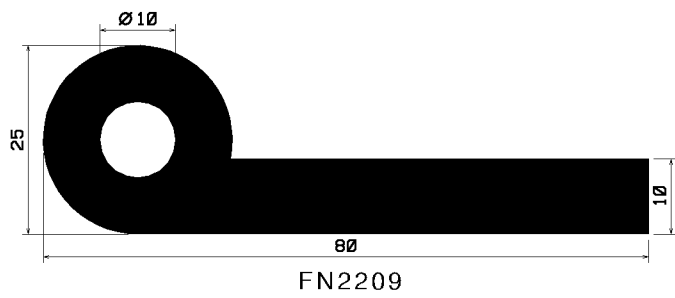
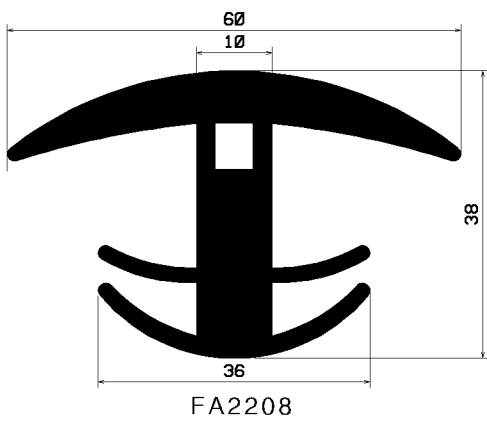
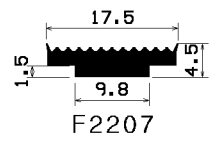
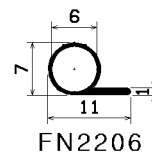
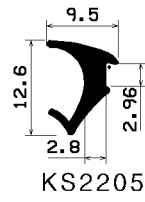
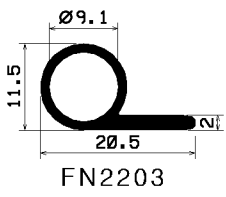
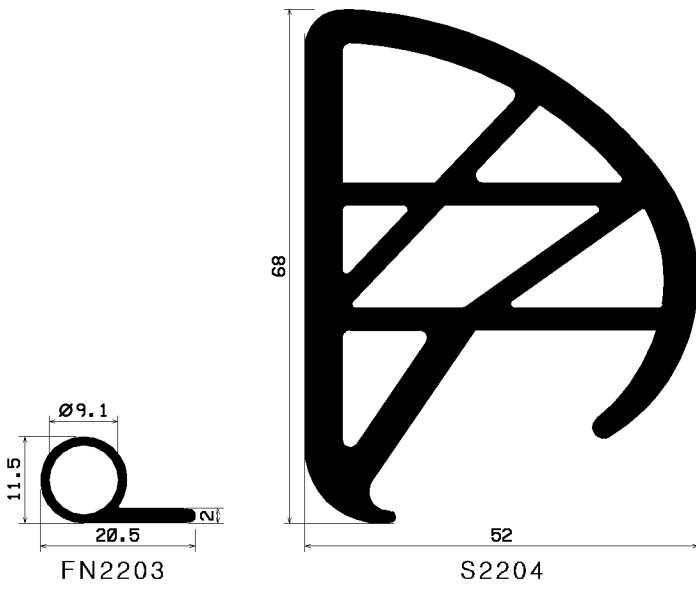
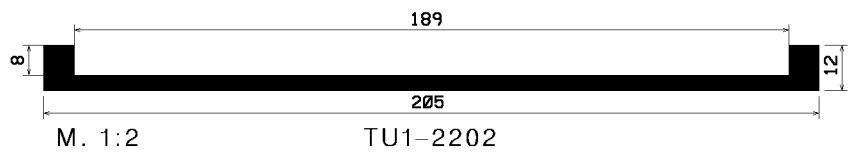
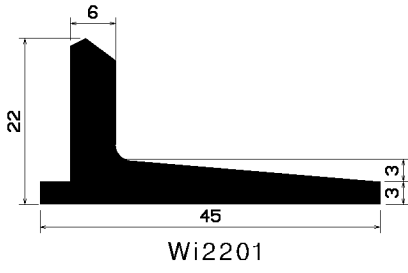
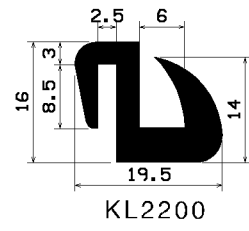
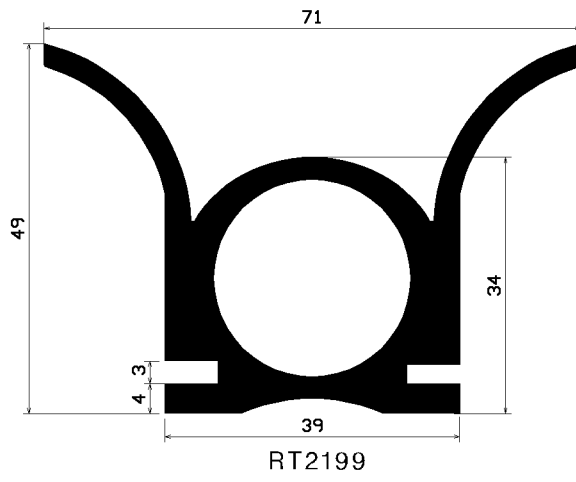
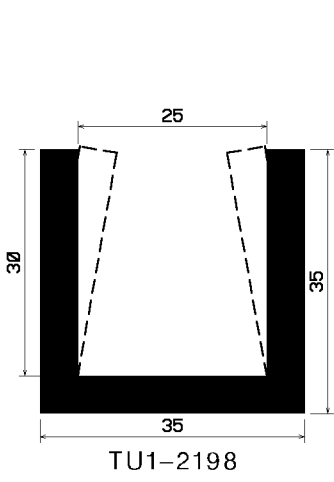

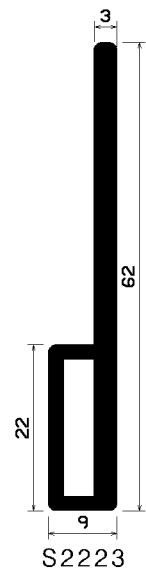
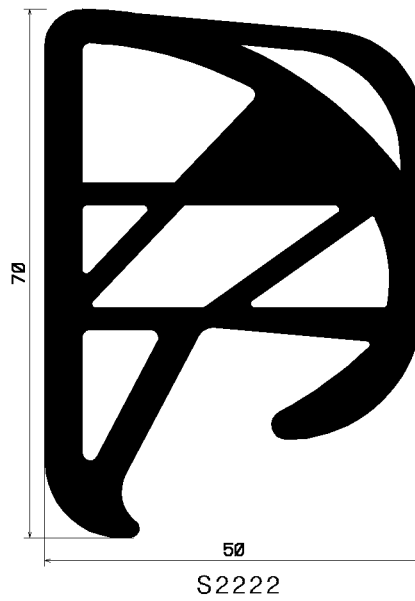
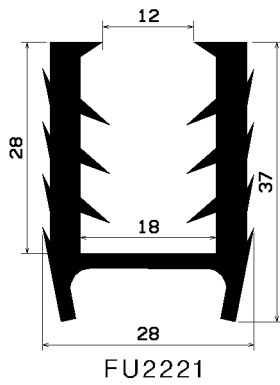
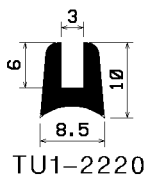
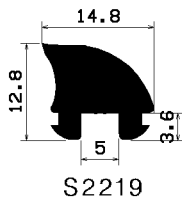
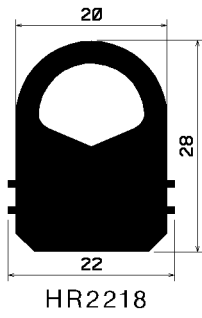
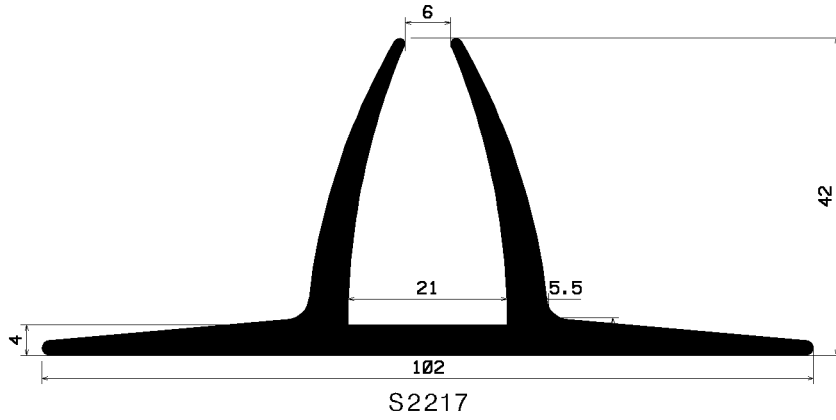
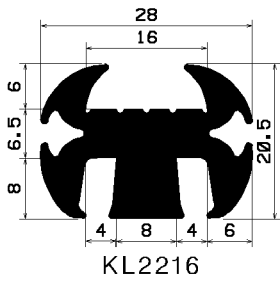
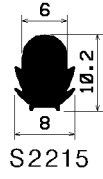
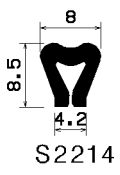
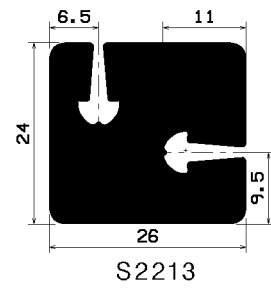
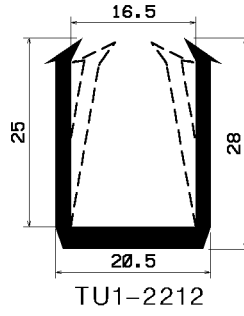
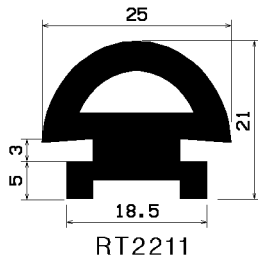
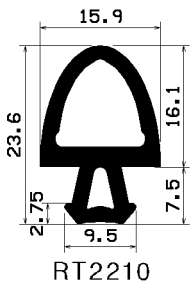

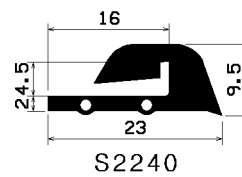
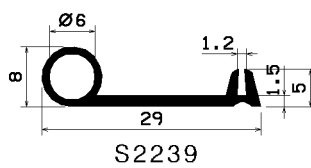
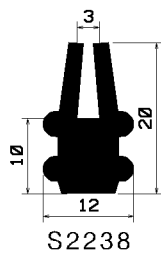
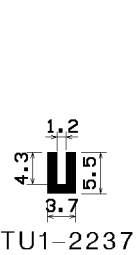
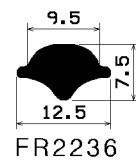
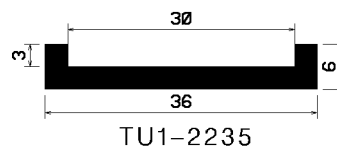
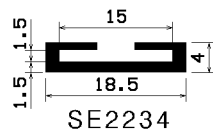
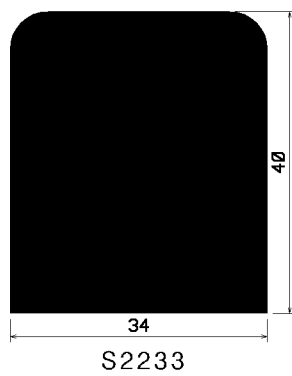
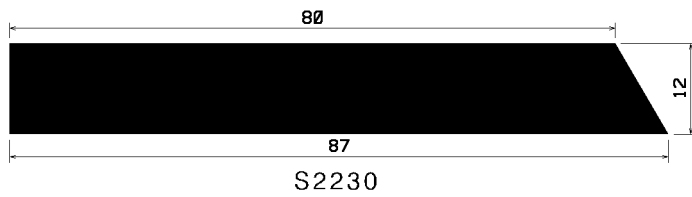
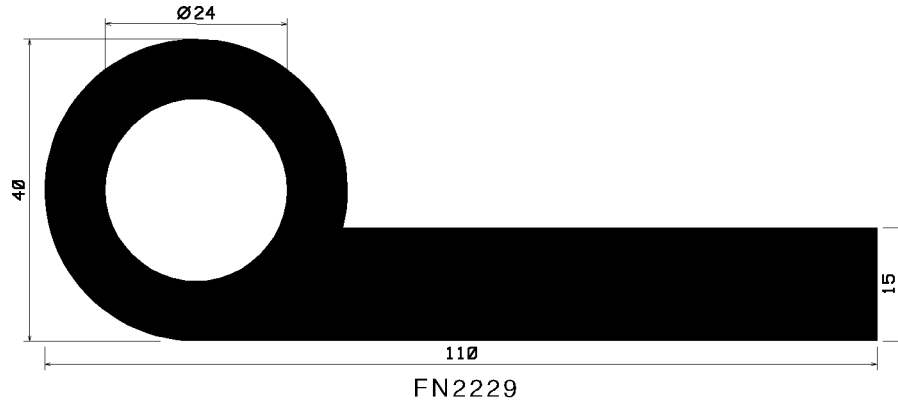
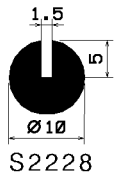
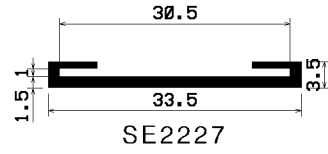
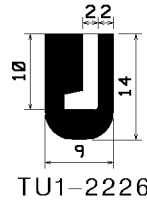
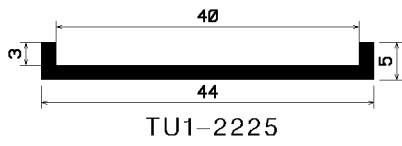
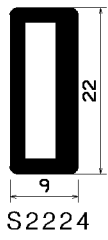

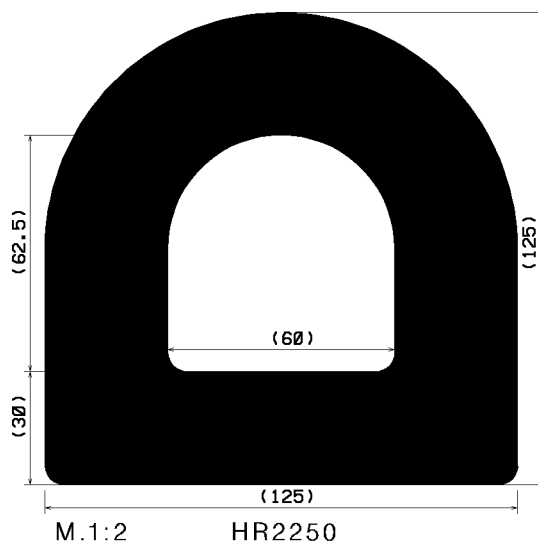
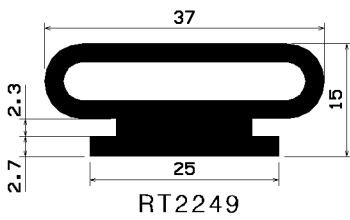
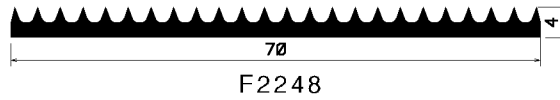
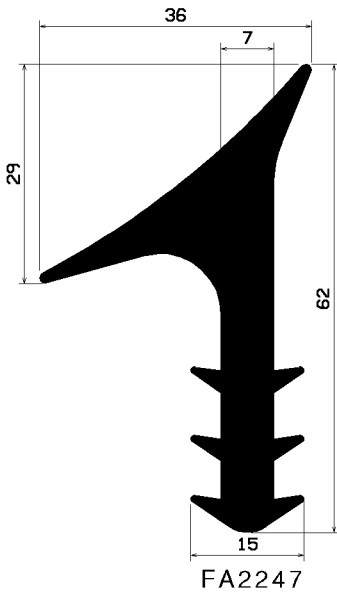
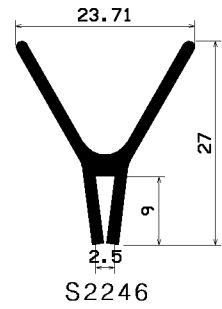
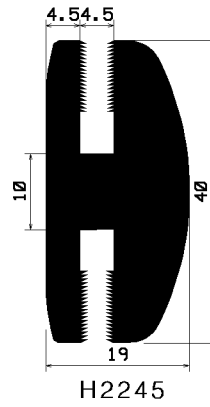
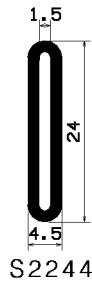
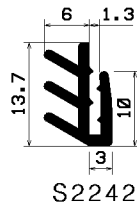
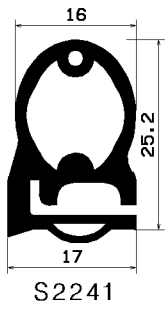

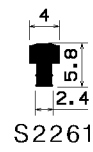
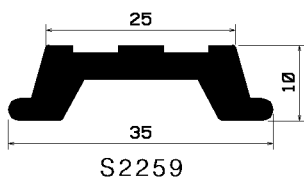
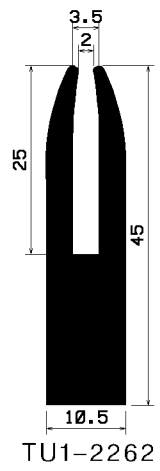
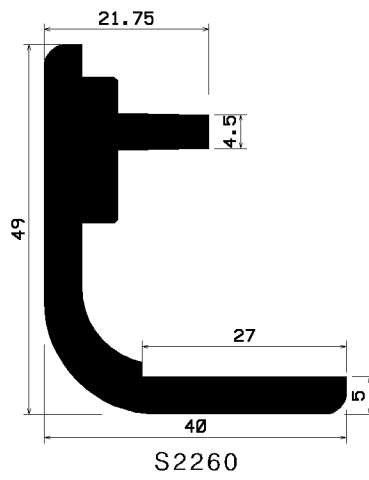
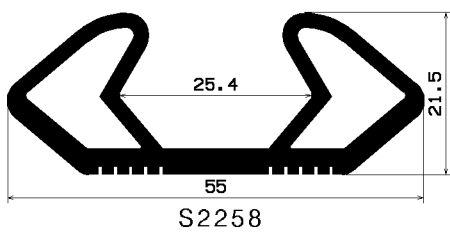
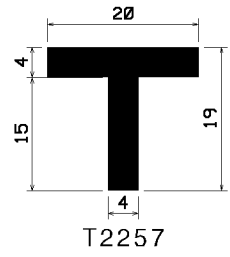
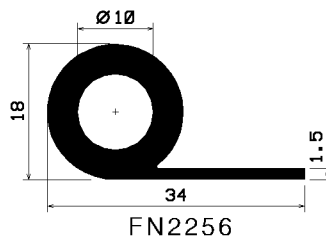
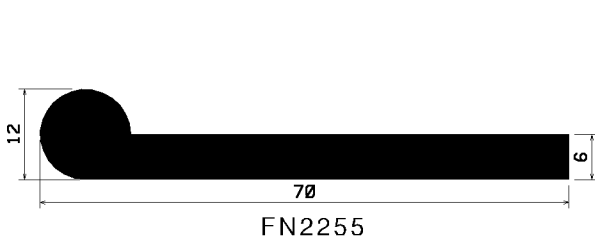
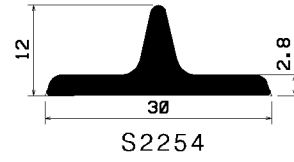
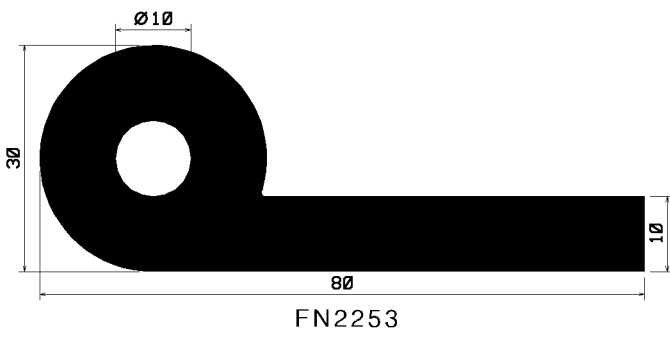
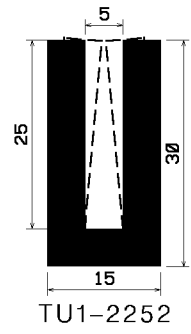
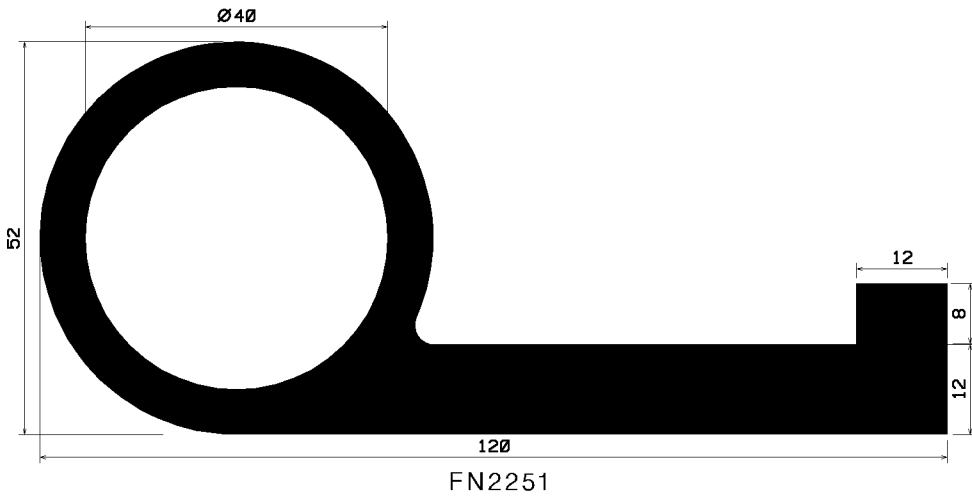

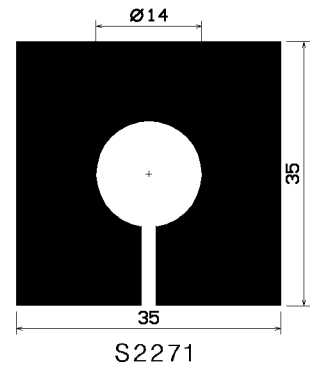
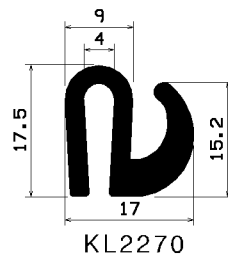
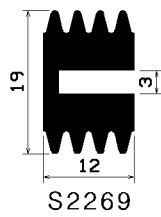
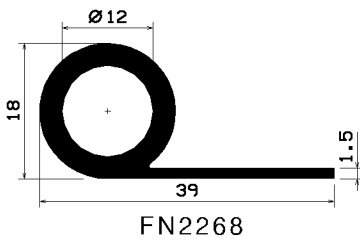
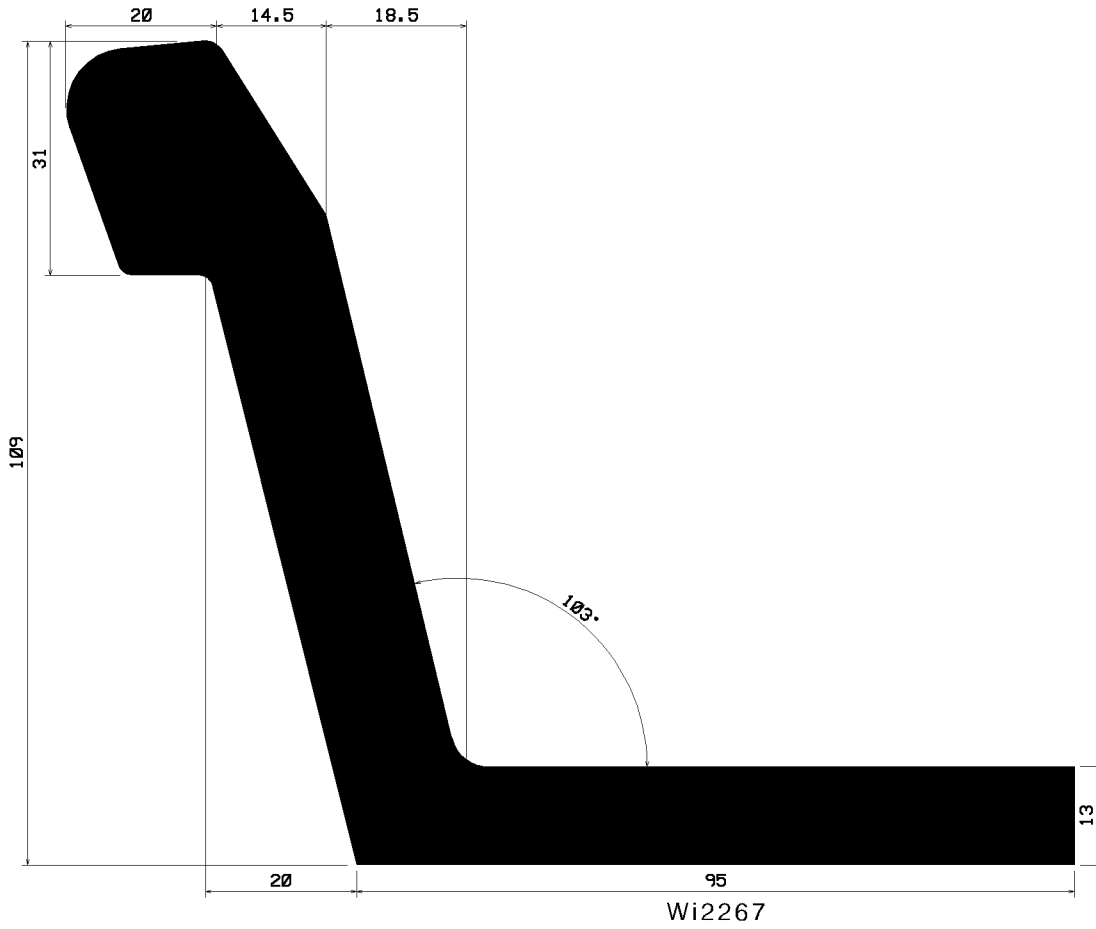
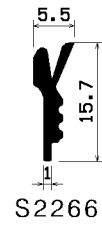
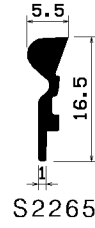
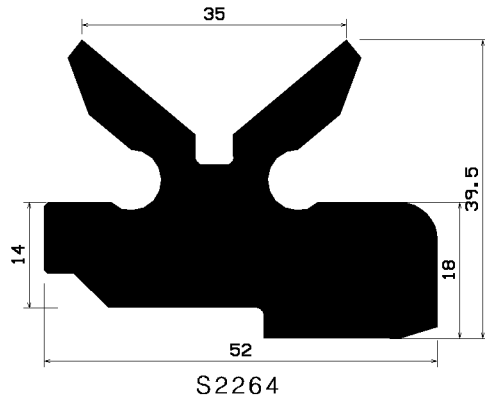
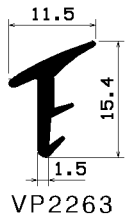

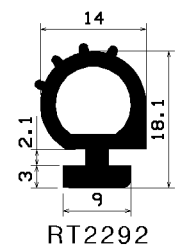
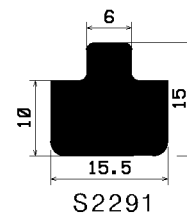
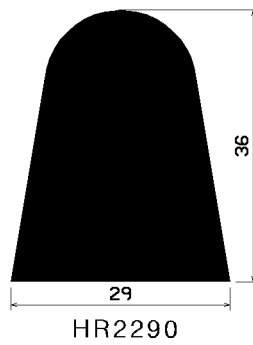
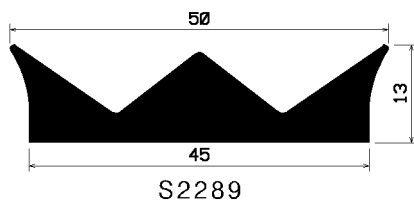
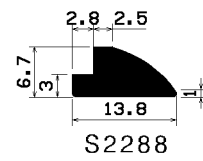
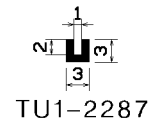
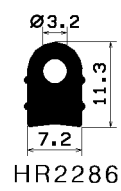
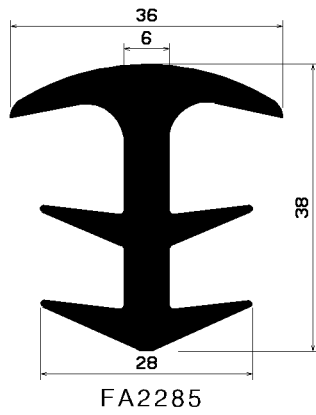
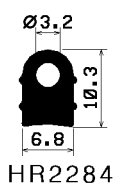
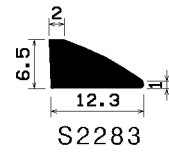
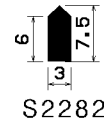
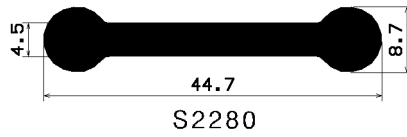
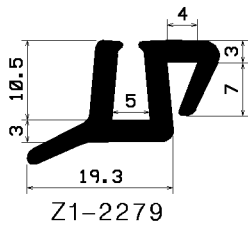
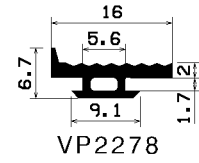
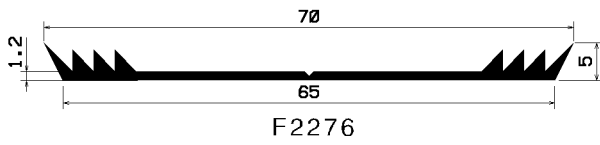
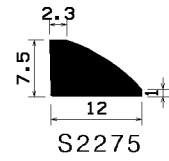
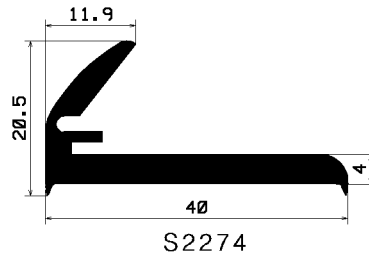
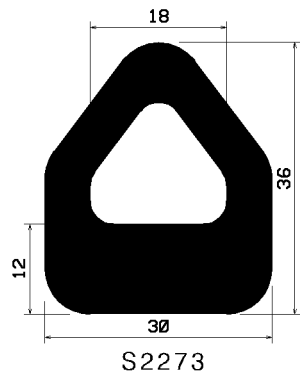
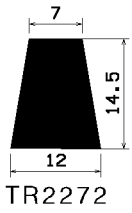

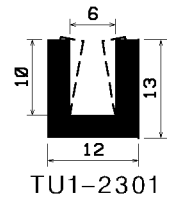
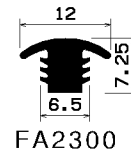
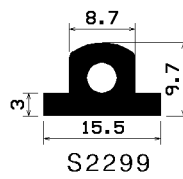
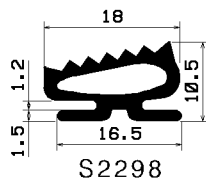
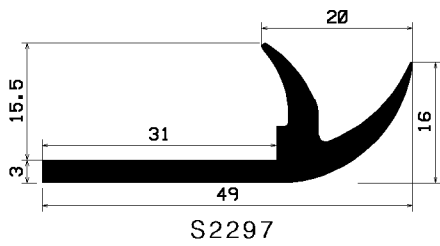
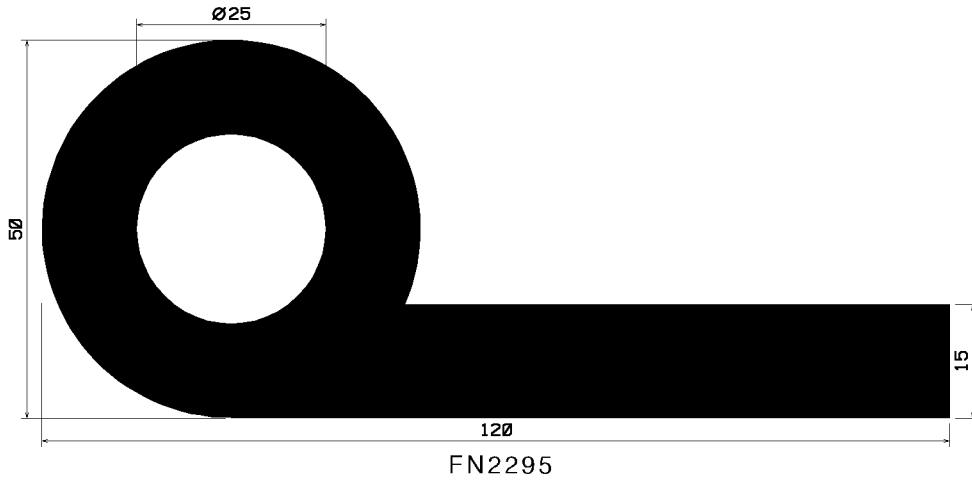
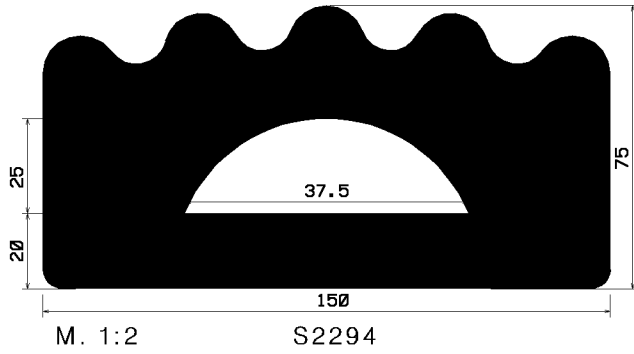
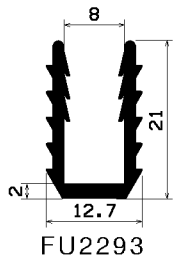

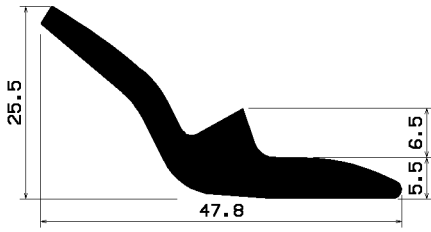

S2302

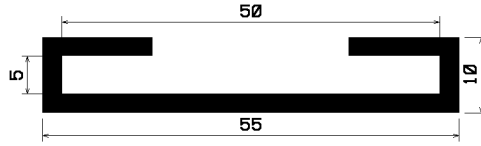

SE2303

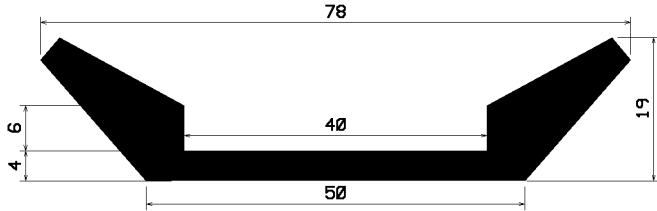

S2304

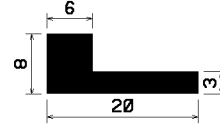

Wi2305

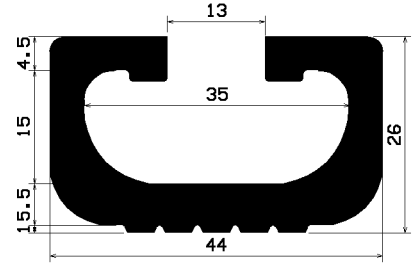

S2306

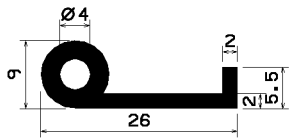

FN2307

FT2308-FT2315

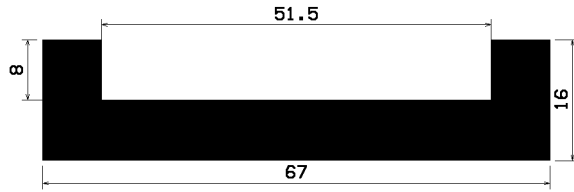

TU1-2316

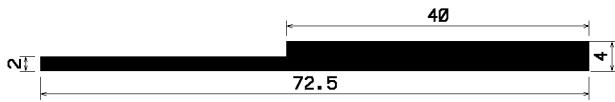

S2317

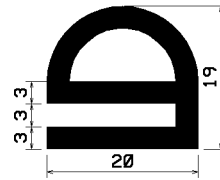

RT2318

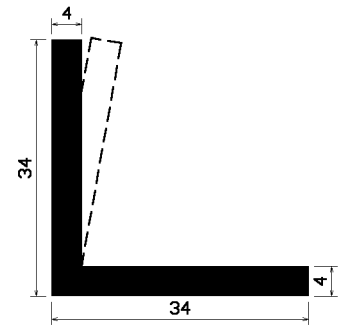

Wi2319

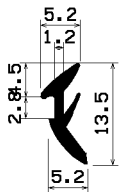

KS2320

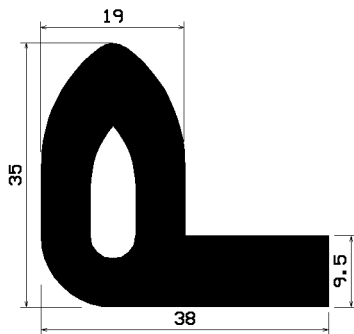

FN2321

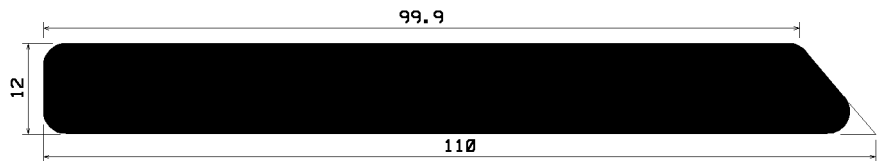

S2322

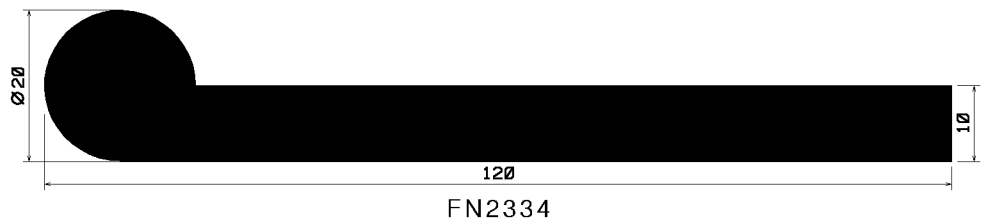
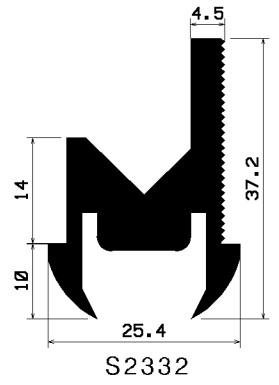
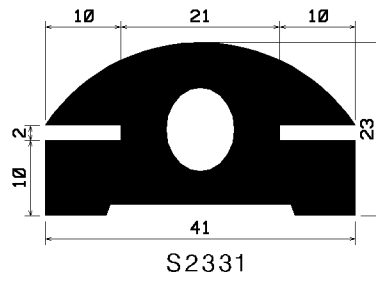
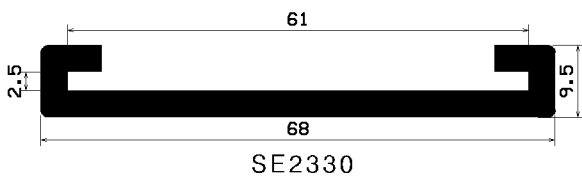
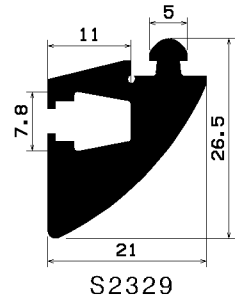
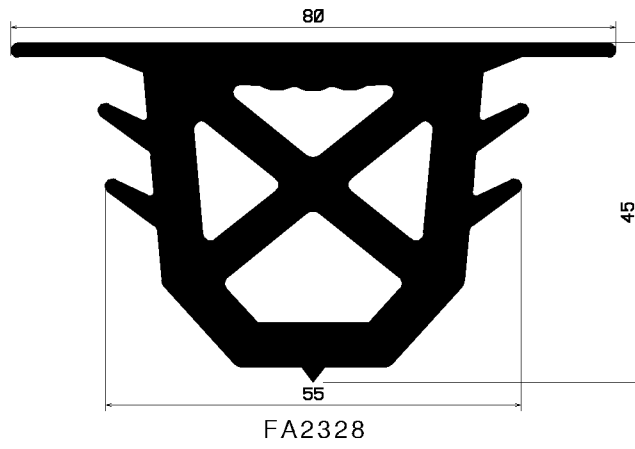
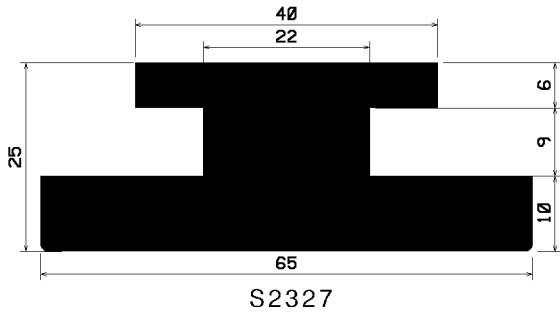
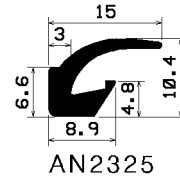
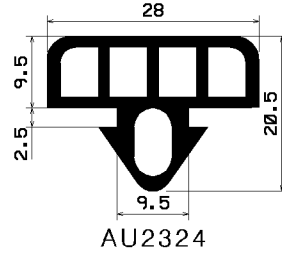
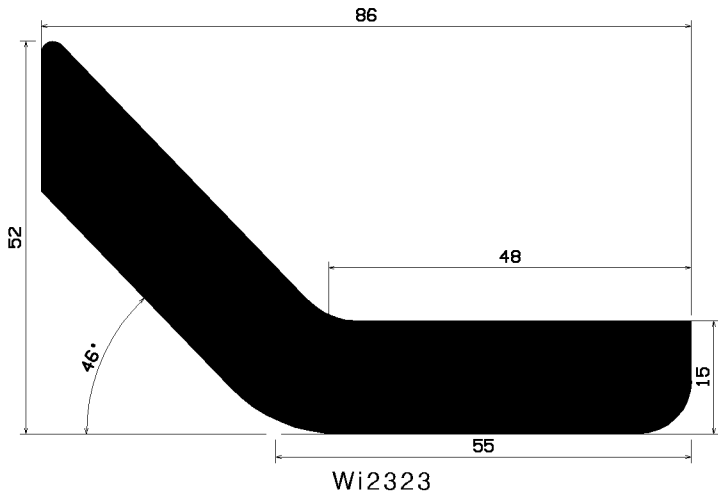

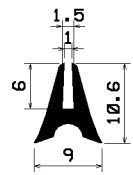

TU1-2335

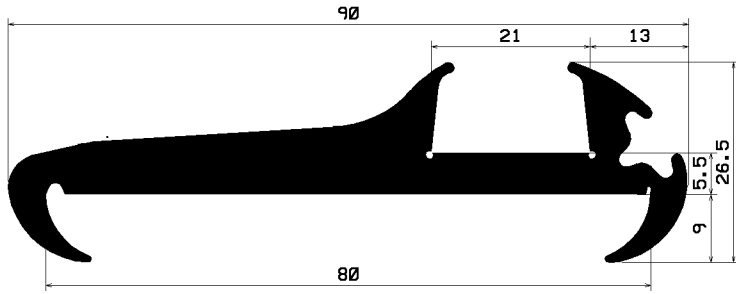

KL2336

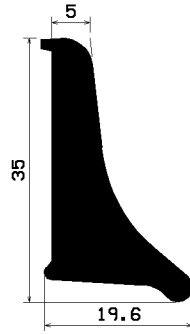

S2337

FT2338

FT2339

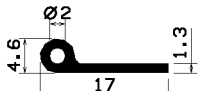

FN2340

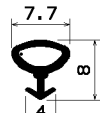

SC2341

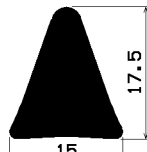

S2342

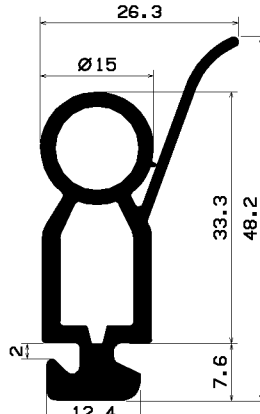

RT2343

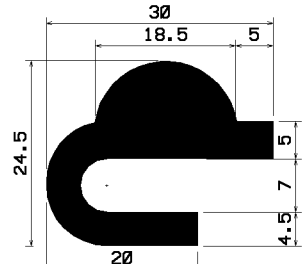

S2344

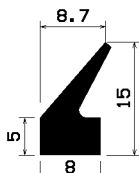

S2345

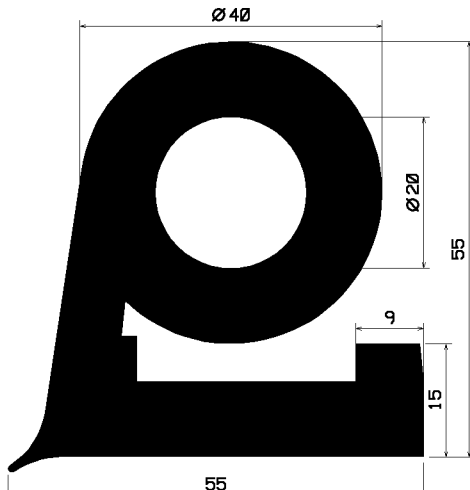

FN2346

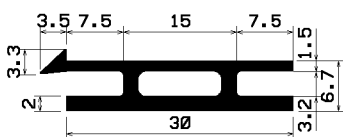

S2347

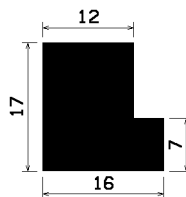

W12348

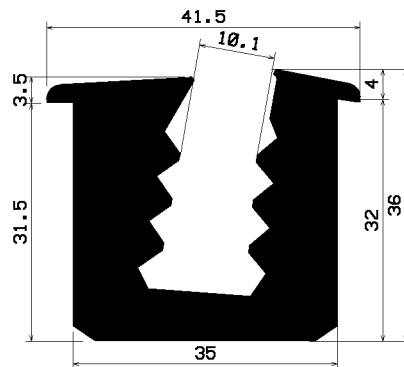

TU1-2349

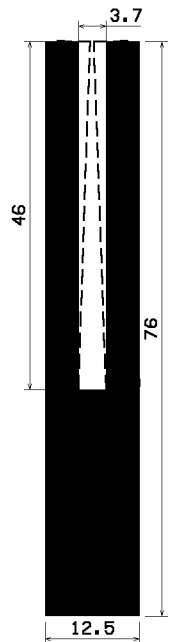

TU1-2350

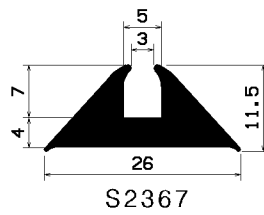
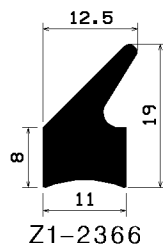
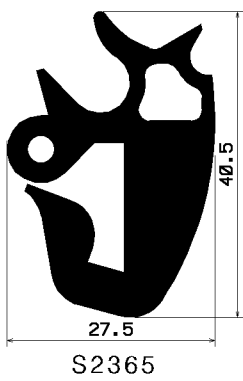
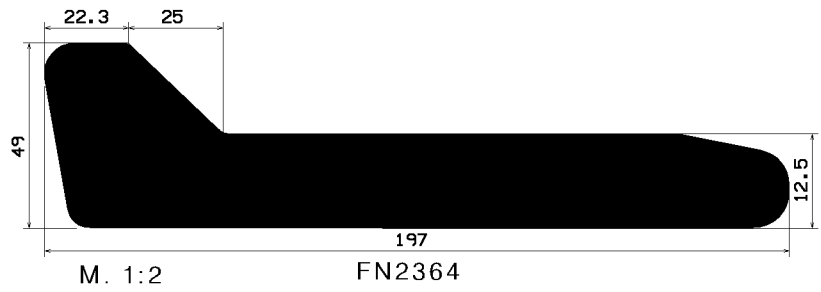
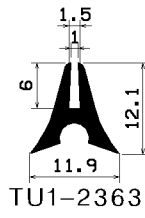
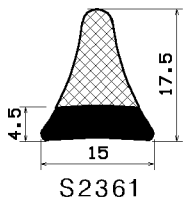
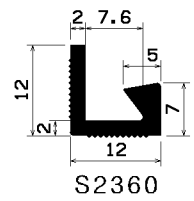
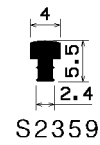
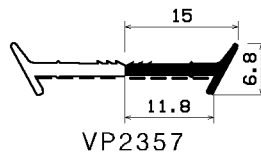
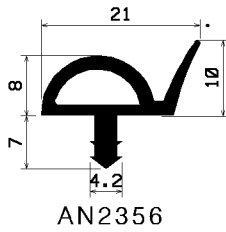
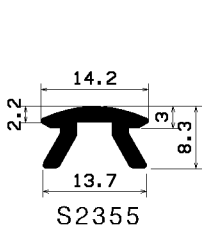
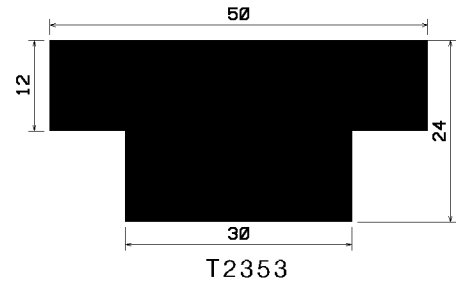
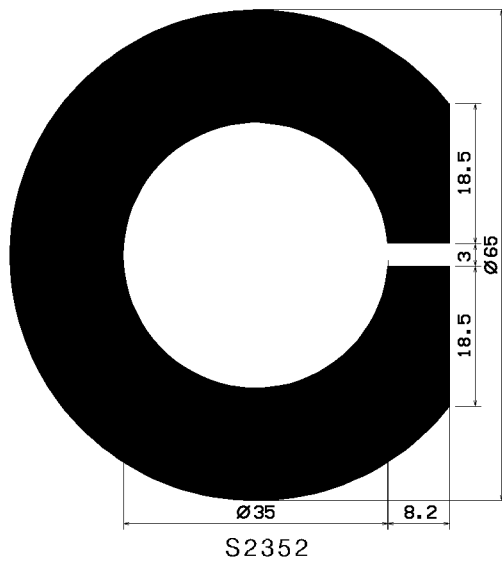
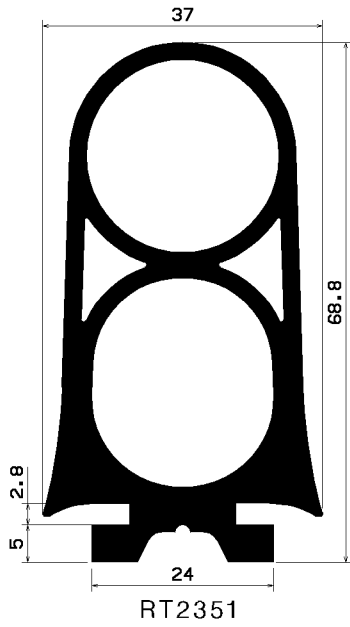

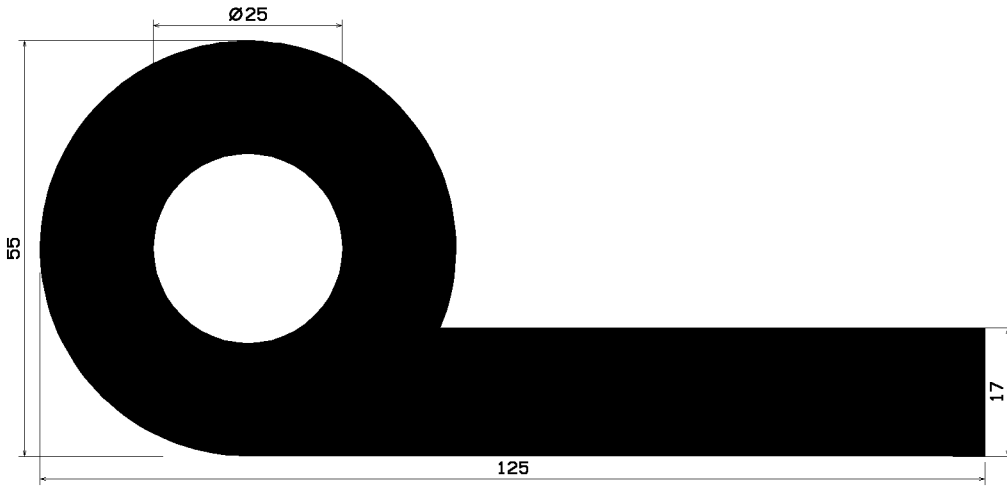

FN2368

FT2369-FT2375

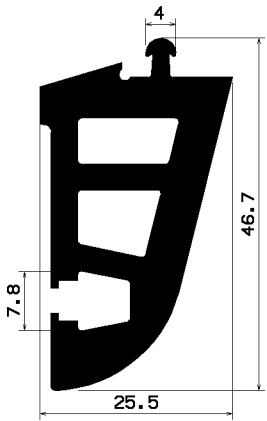

S2376

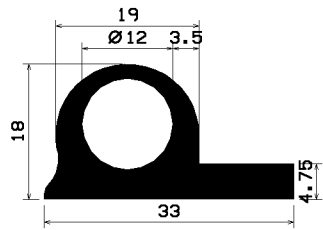

FN2377

FT2378

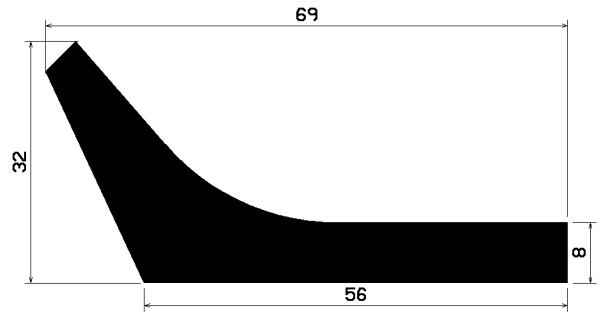

Wi2379

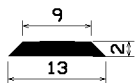

TR2380

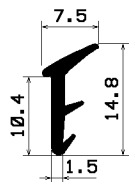

VP2381

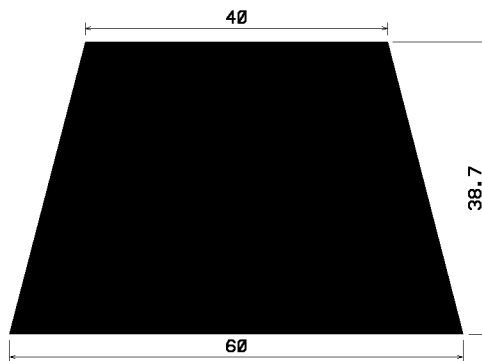

TR2382

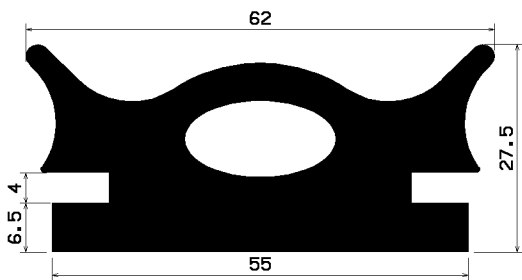

S2383

FT2384

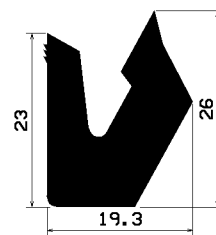

S2385

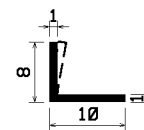

Wi2386

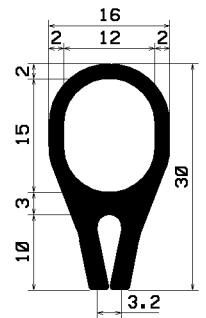

S2387

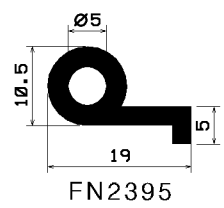
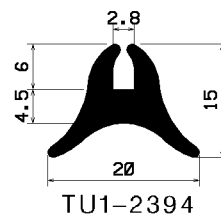
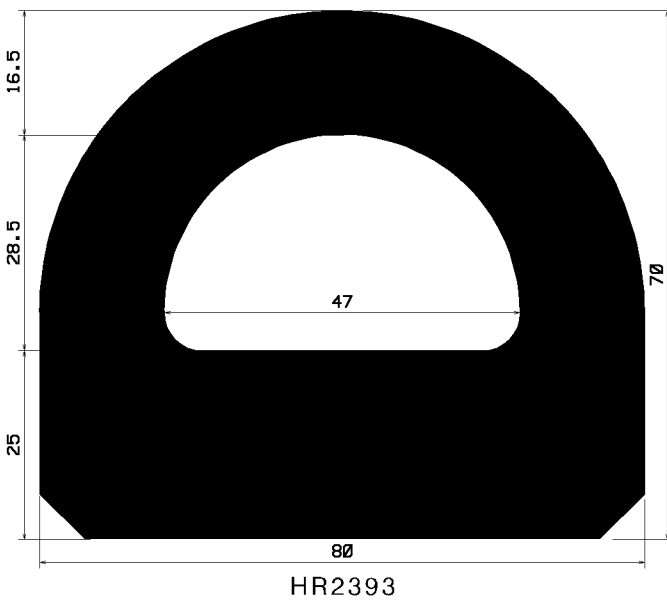
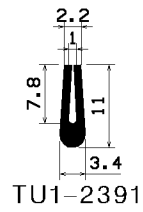
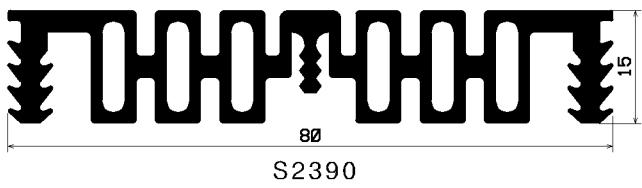
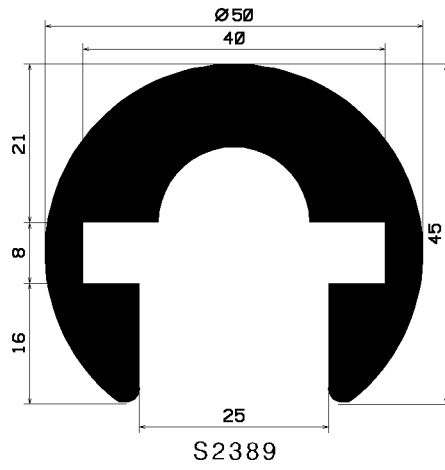
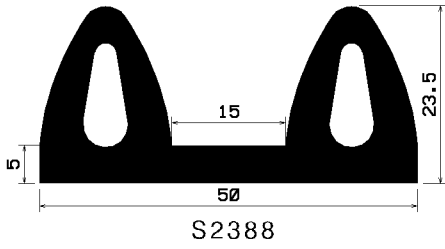

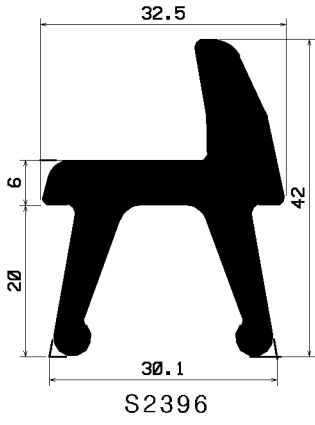

FT2397
FT2398

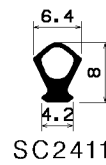
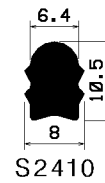
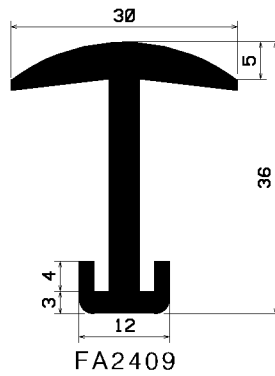
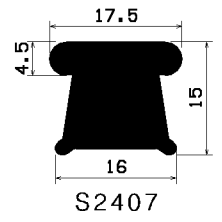
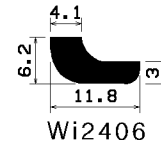
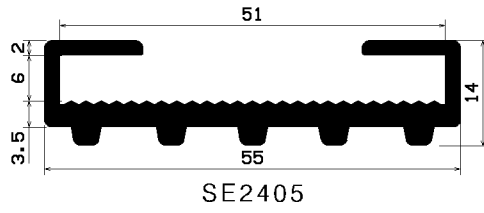
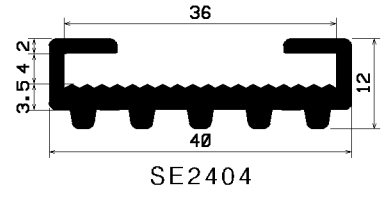
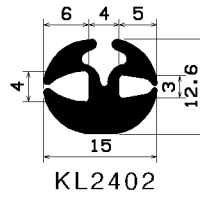
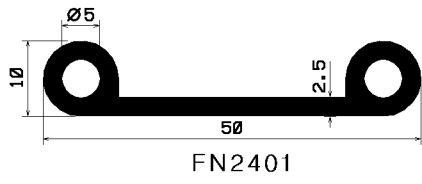
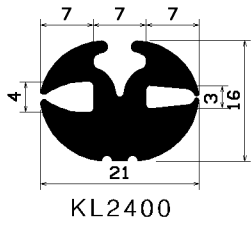
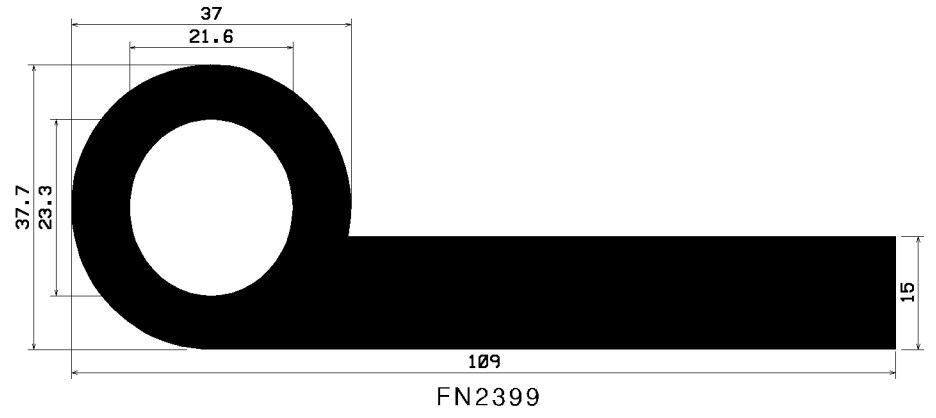

FT2412

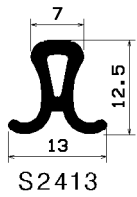

S2413

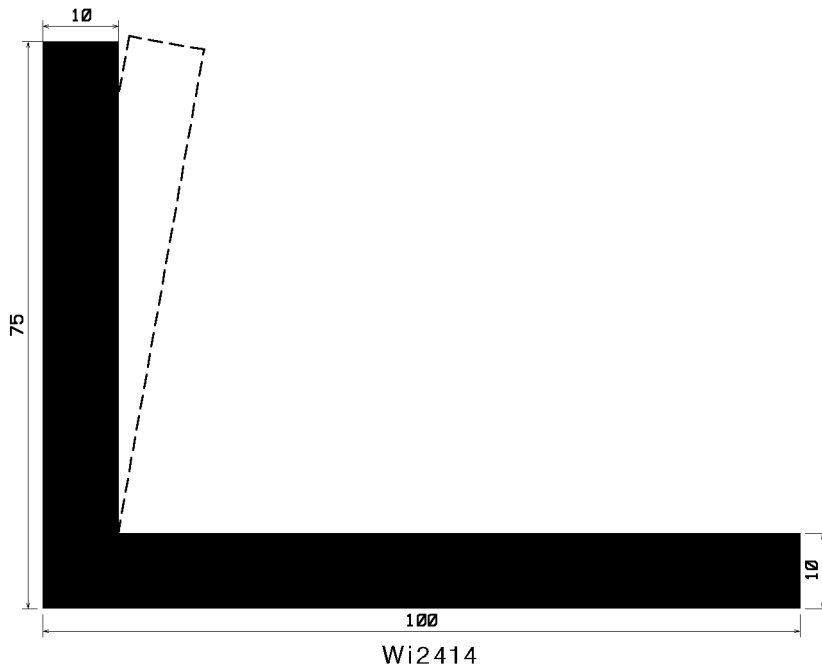

Wi2414

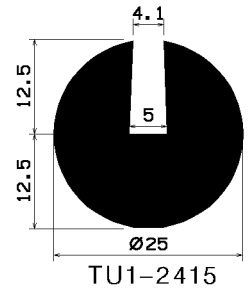

TU1-2415

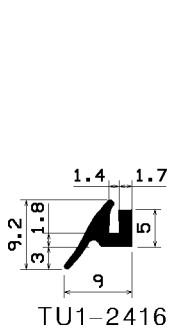

TU1-2416

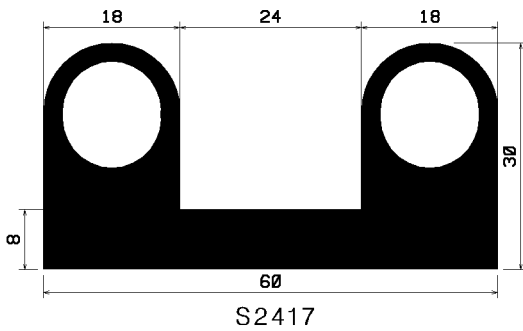

S2417

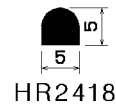

HR2418

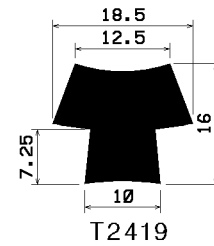

T2419

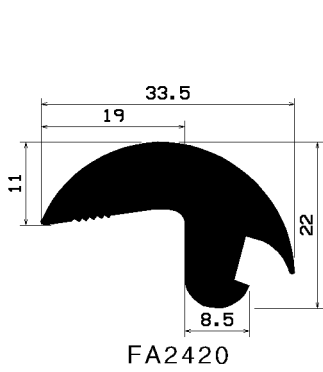

FA2420

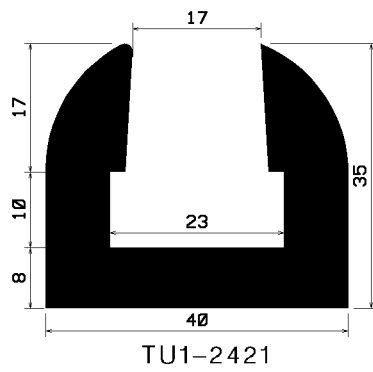

TU1-2421

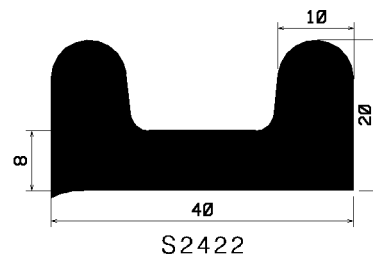

S2422

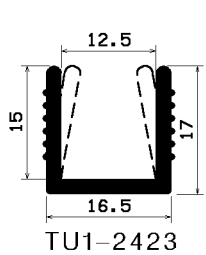

TU1-2423

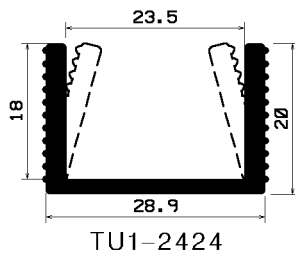

TU1-2424

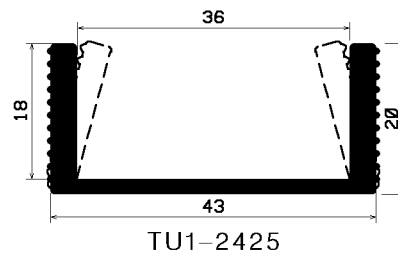

TU1-2425

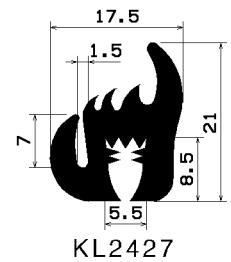

KL2427

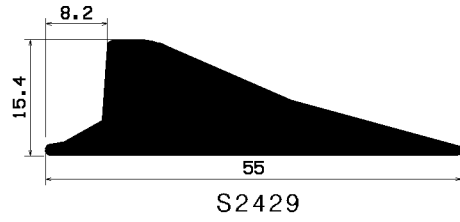
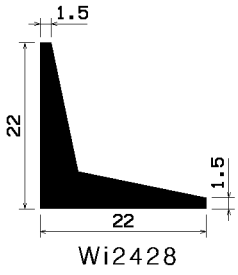

FT2430-
FT2434

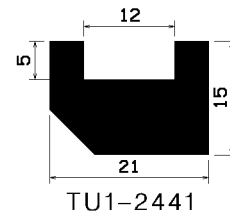
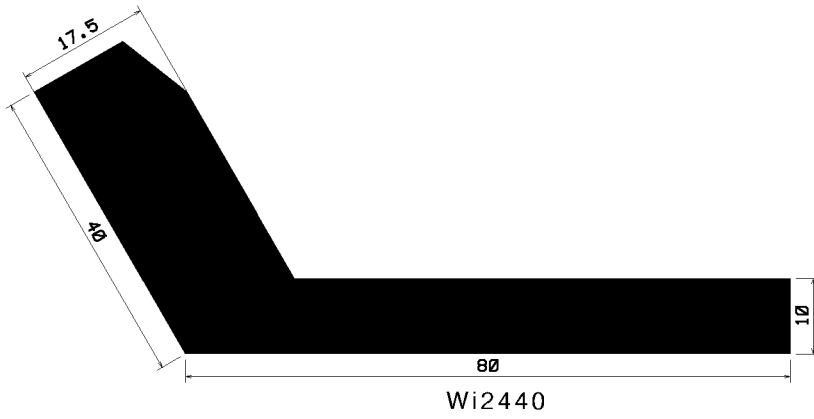
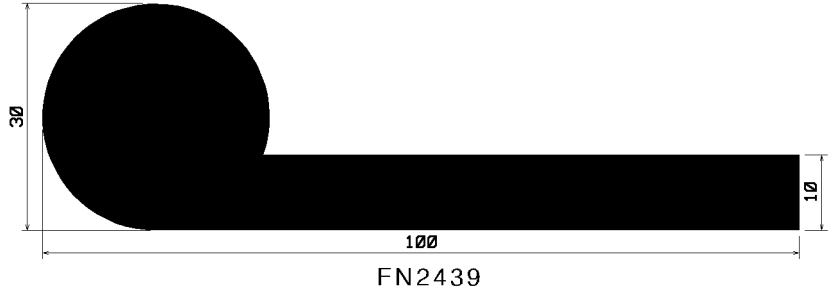
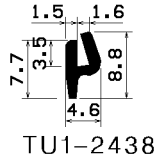
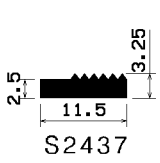
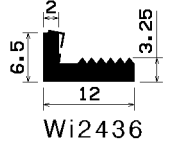
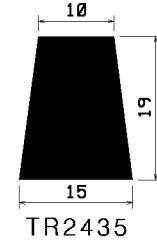

FT2442

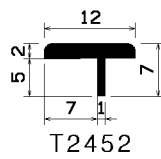
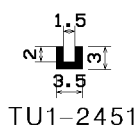
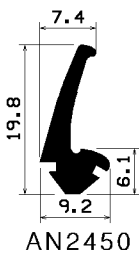
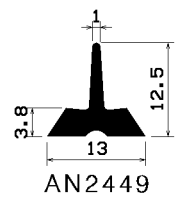
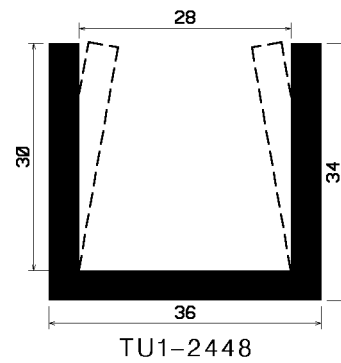
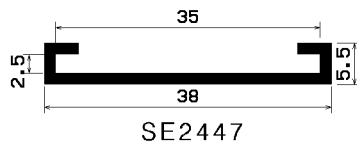
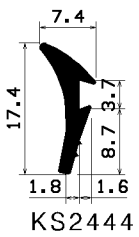
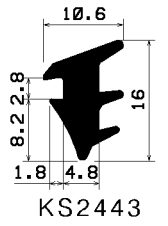

FT2453

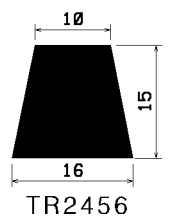
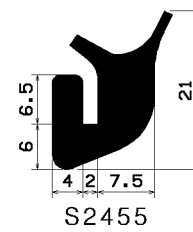
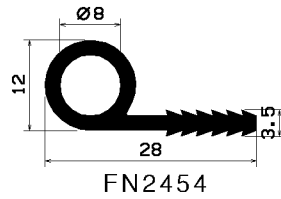

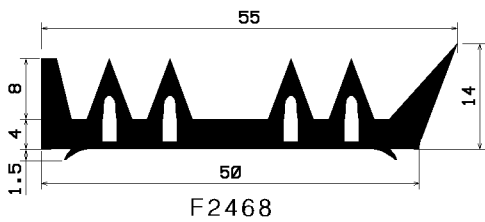
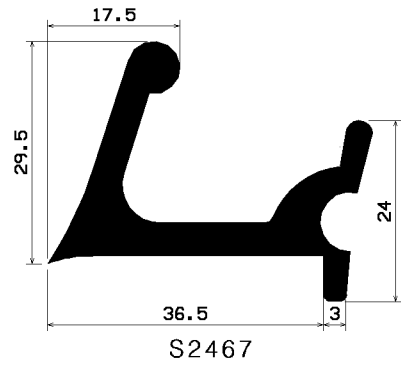
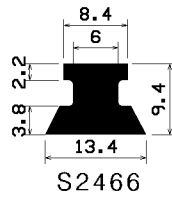
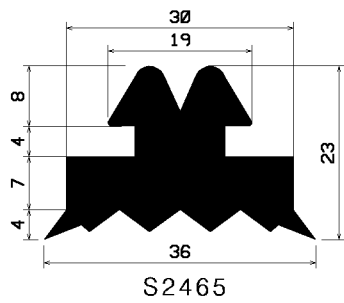
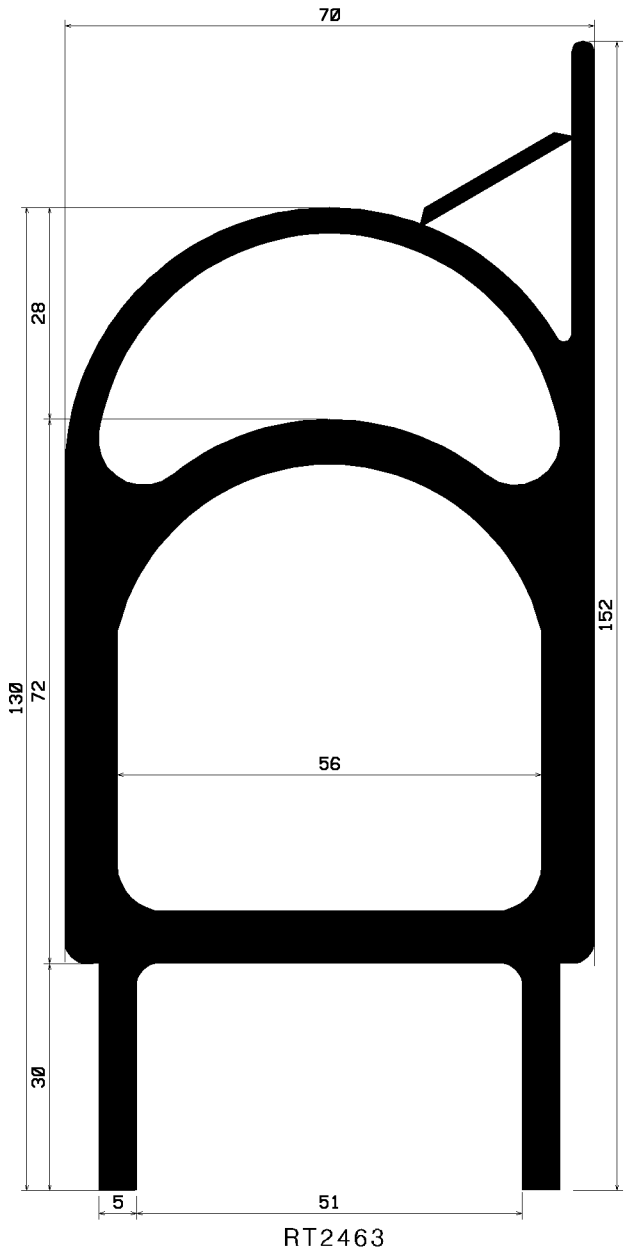
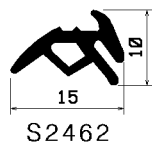
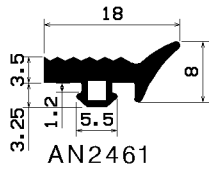
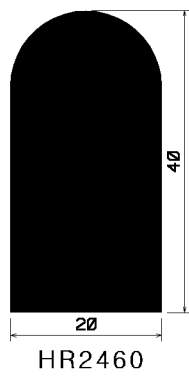
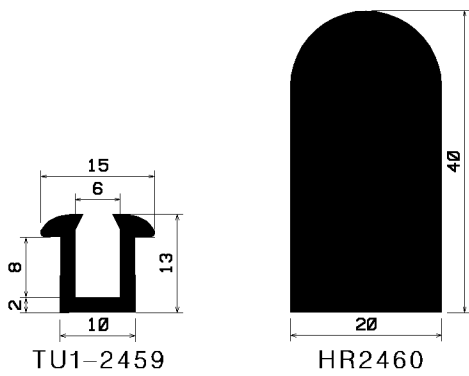
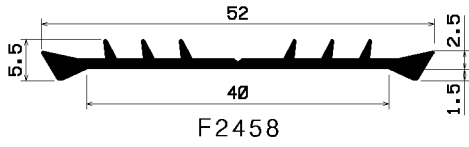
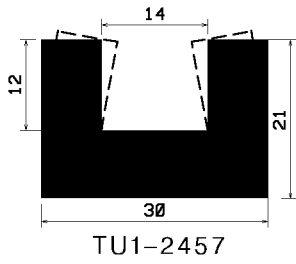

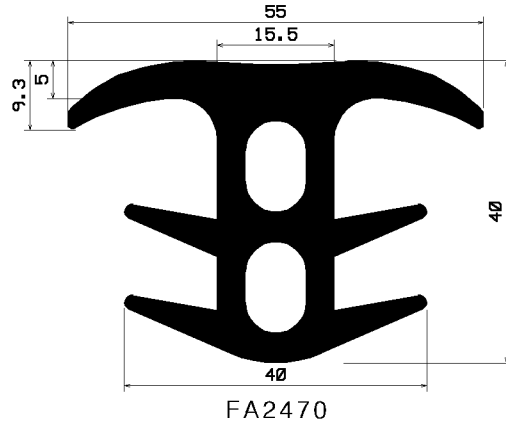
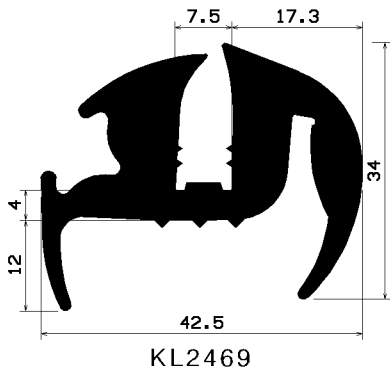

FT2471-
FT2472

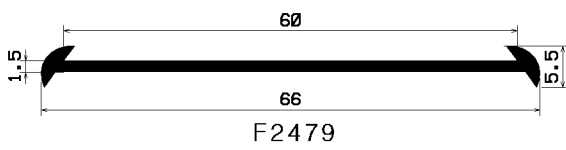
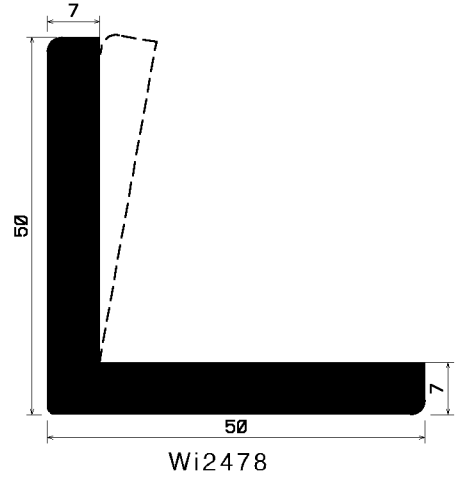
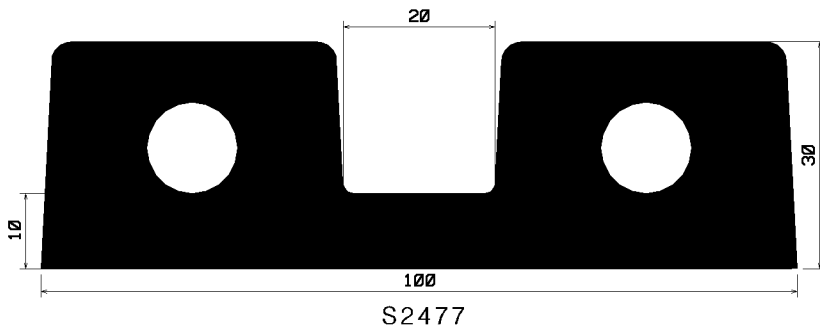
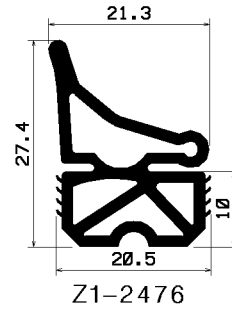
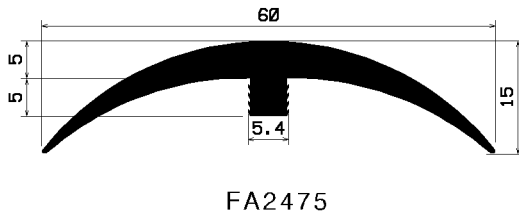
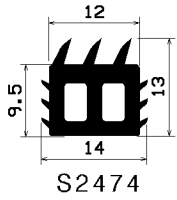
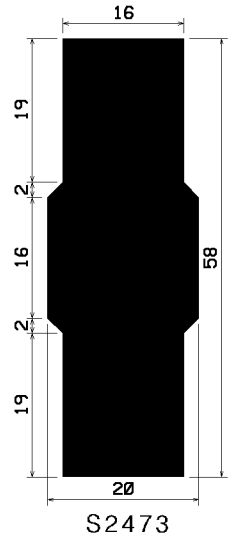

FT2480

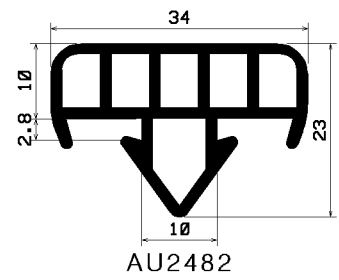
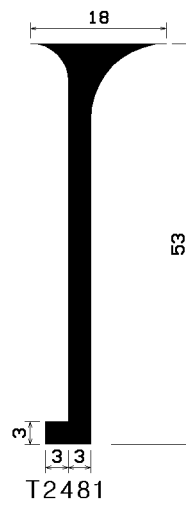

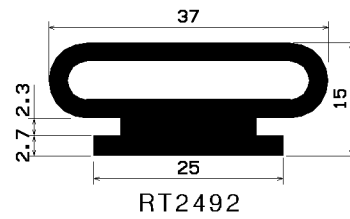
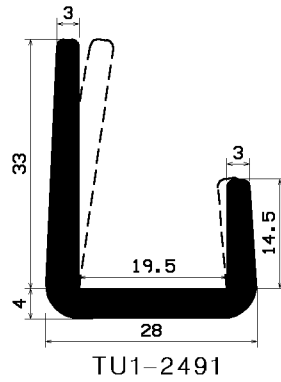
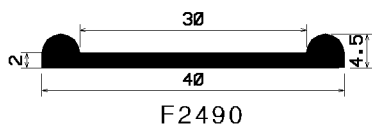
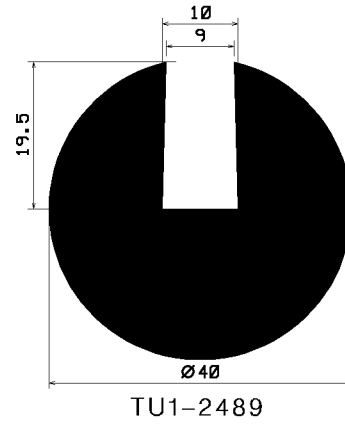
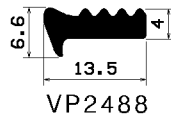
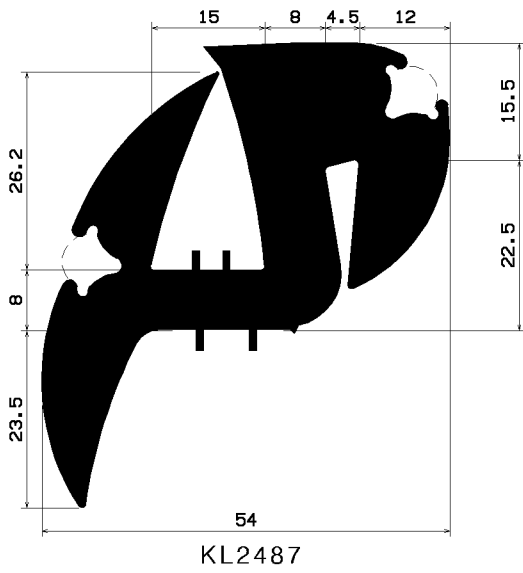
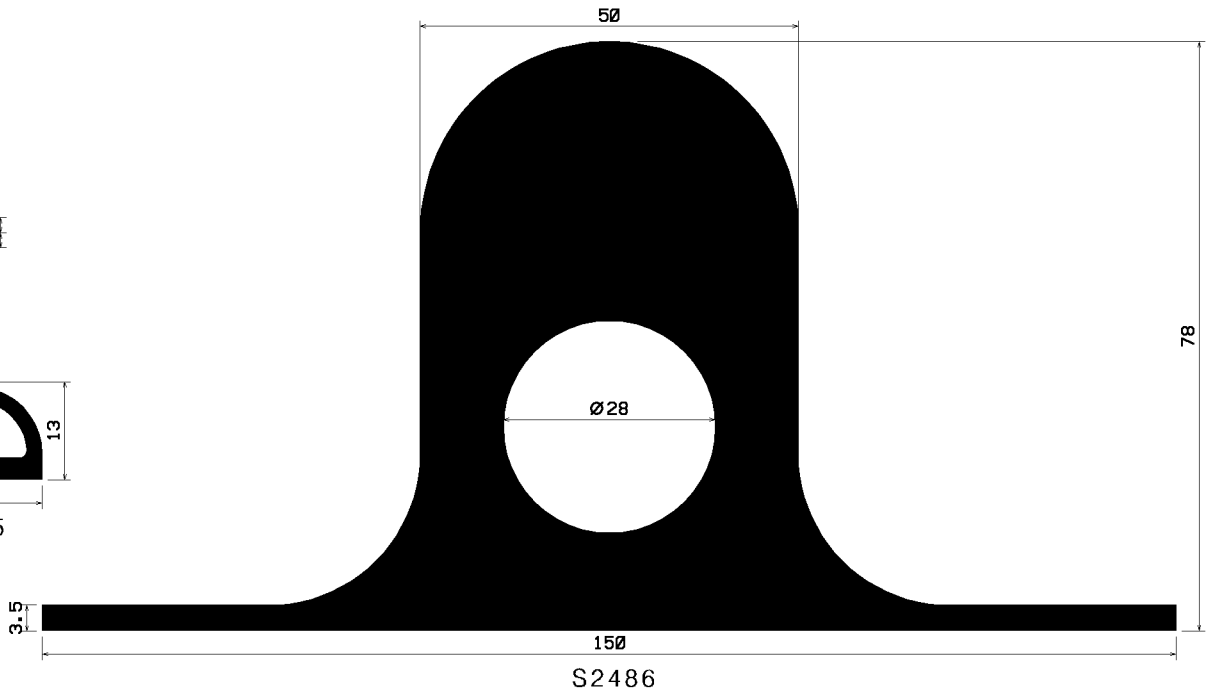
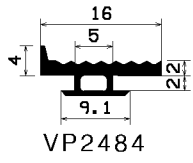

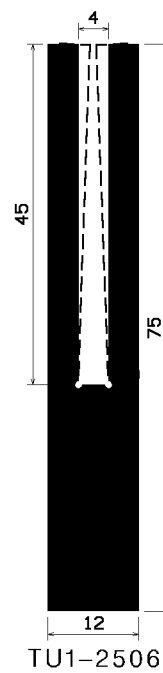
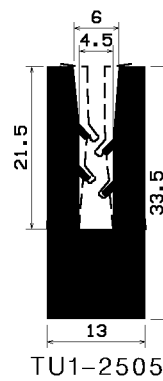
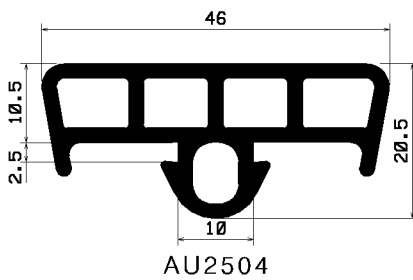
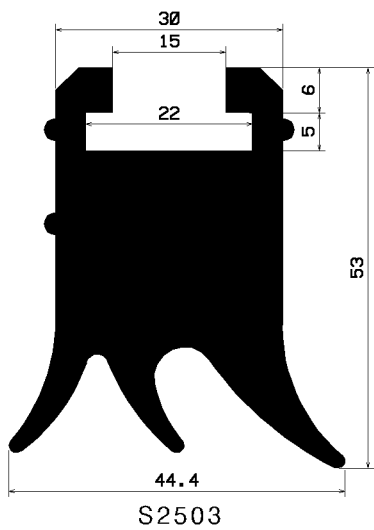
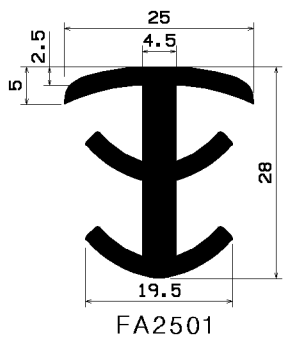
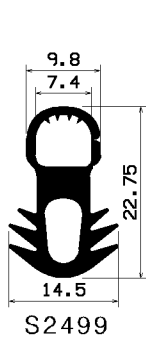
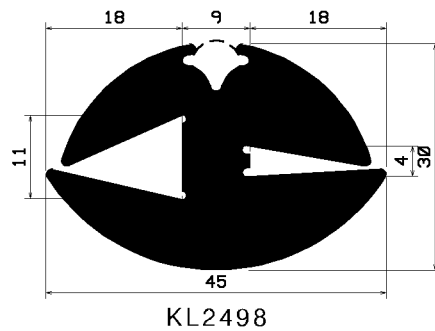
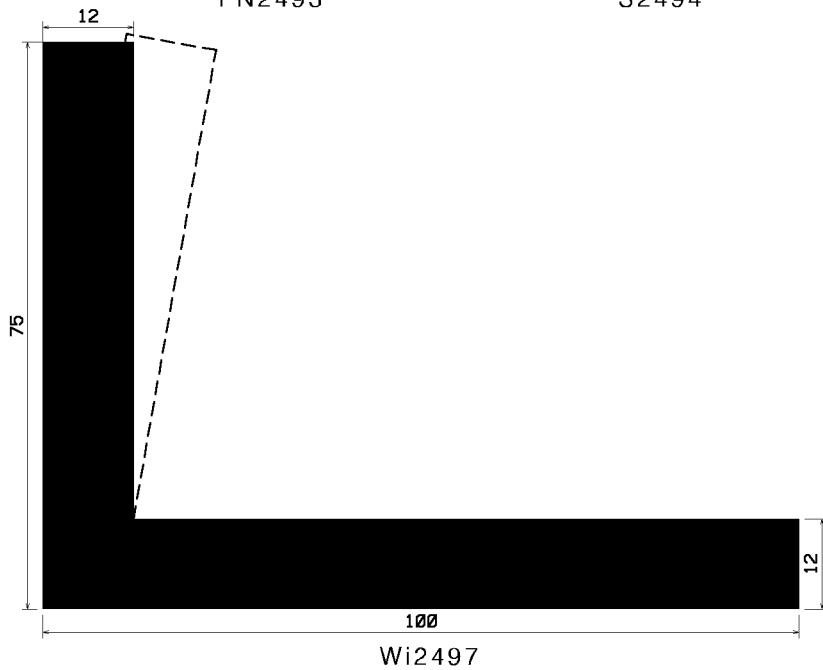
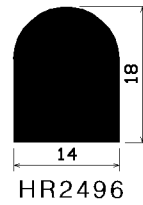
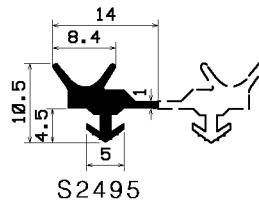
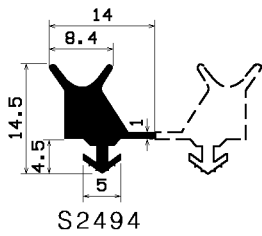
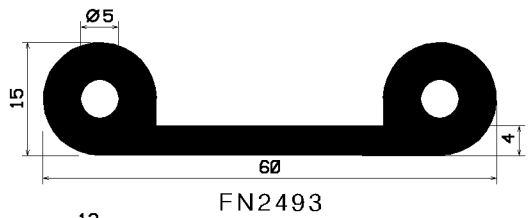

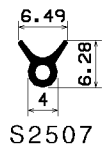
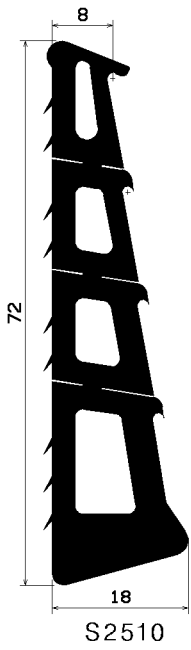

FT2508

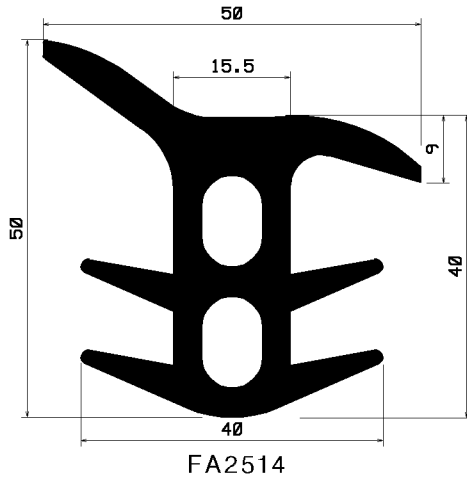
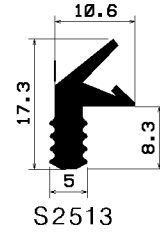
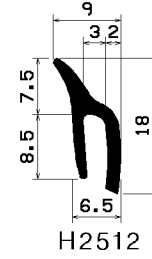
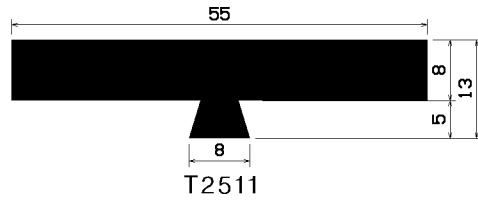
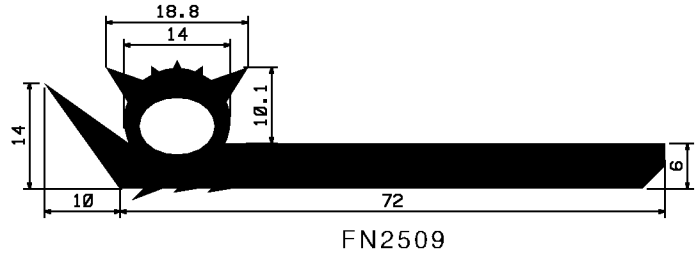

FT2515

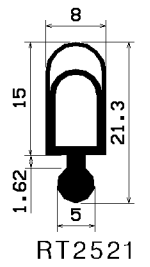
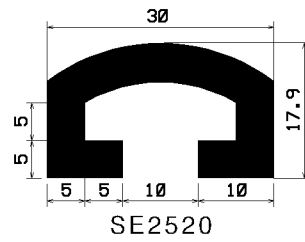
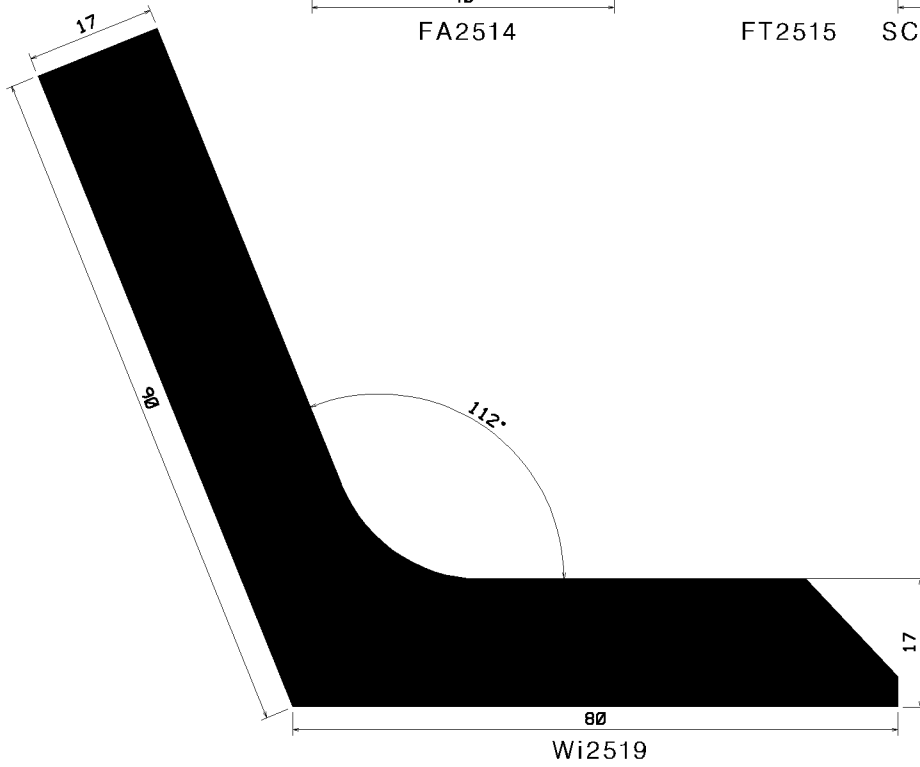
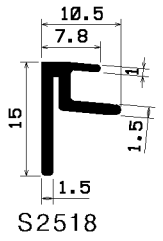
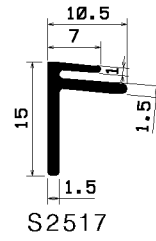
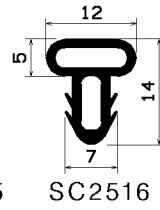

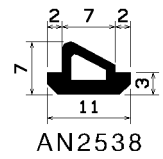
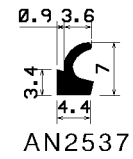
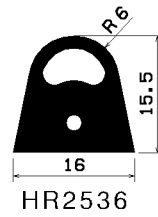
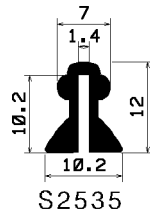
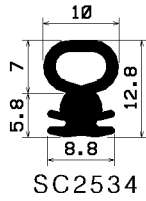
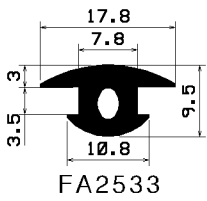
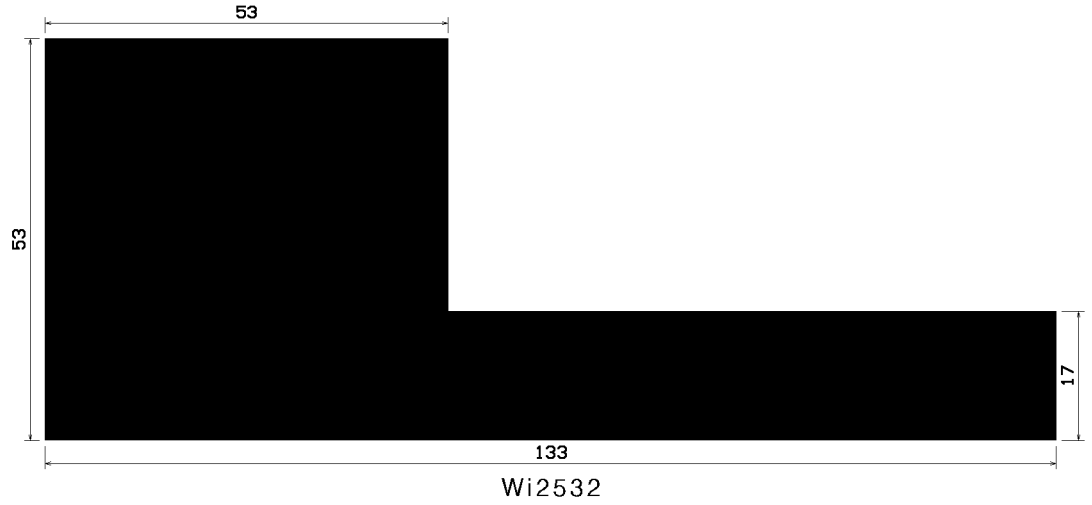
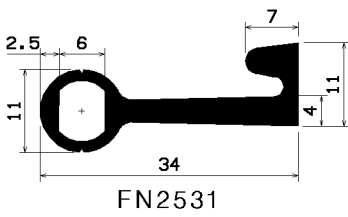
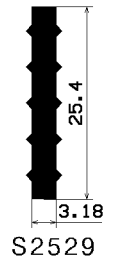
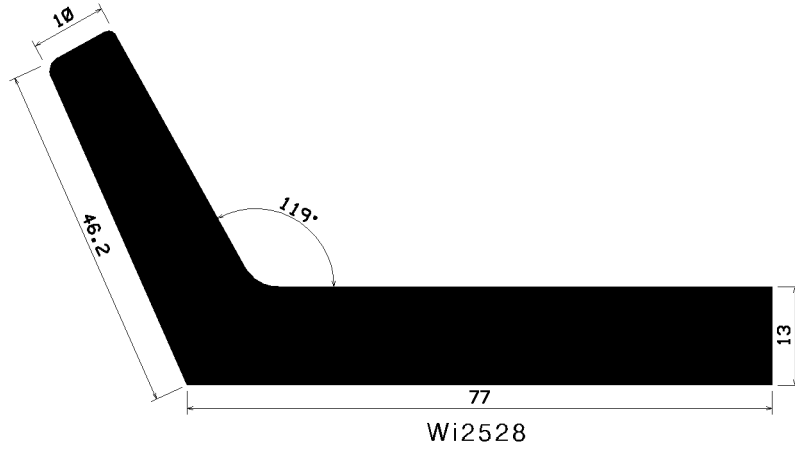
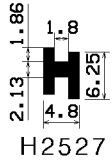
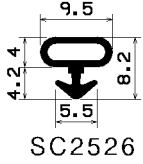
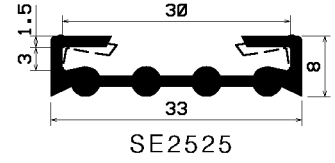
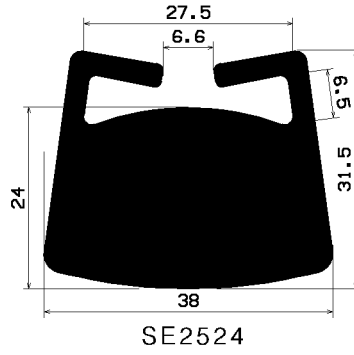
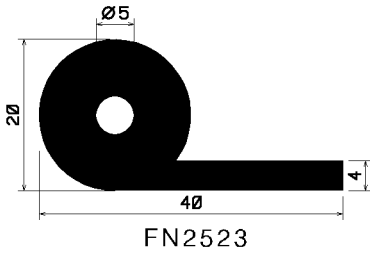
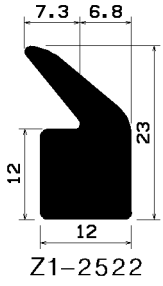

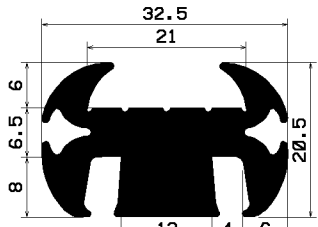

FT2539
FT2540

KL2541

FT2542

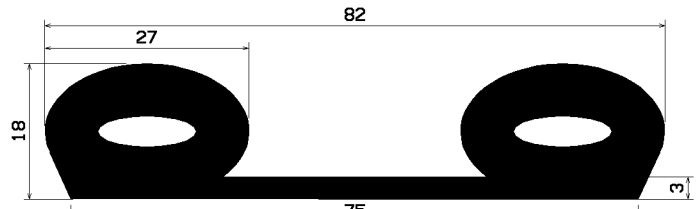

FN2543

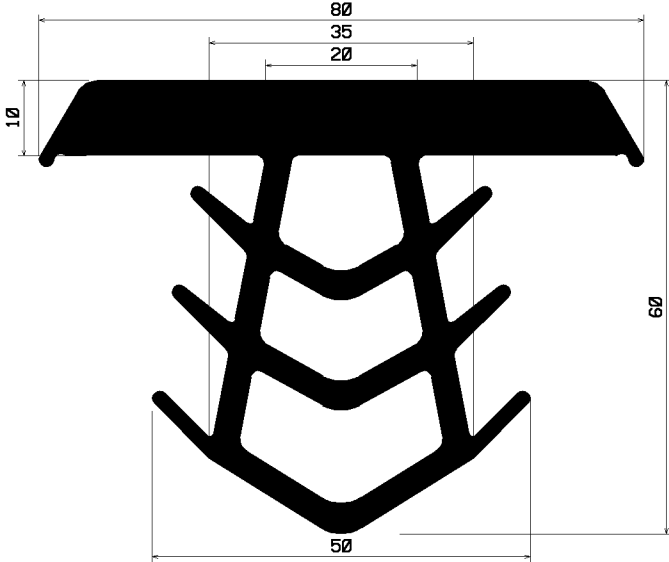

FA2544

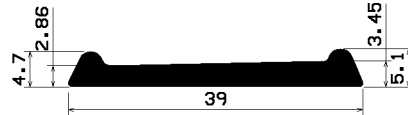

F2545

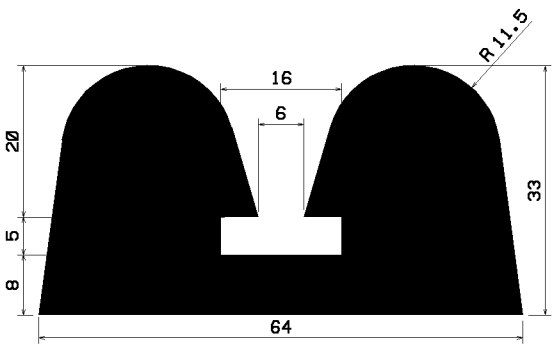

S2546

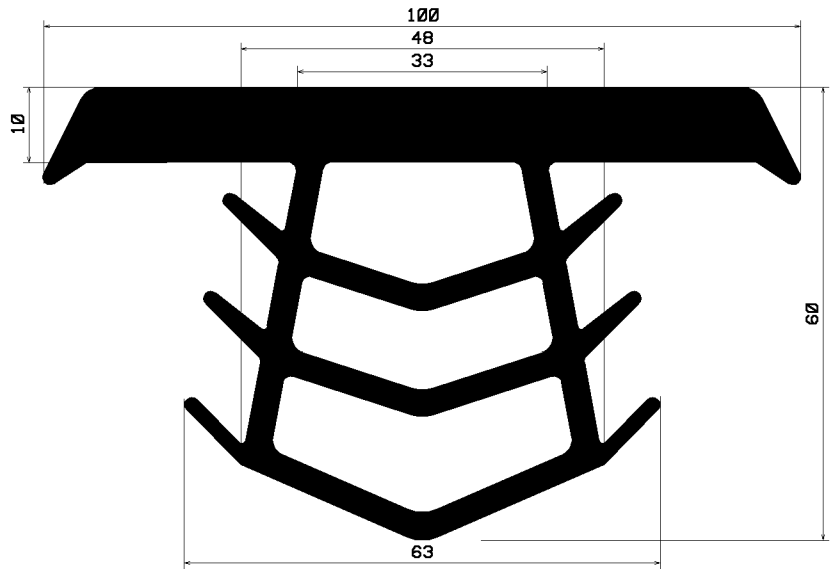

FA2548

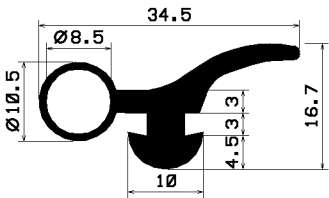

S2547

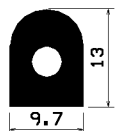

FT2549

HR2550

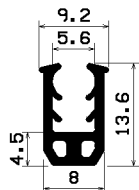

TU1-2551

FT2552-FT2556

FT2557

FT2558

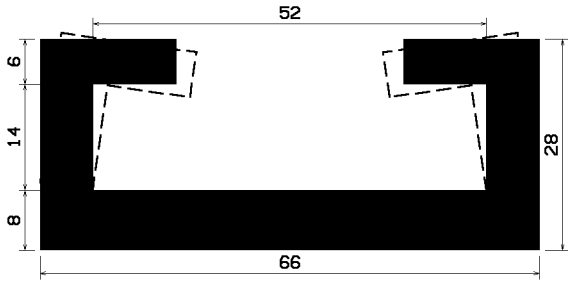

SE2559

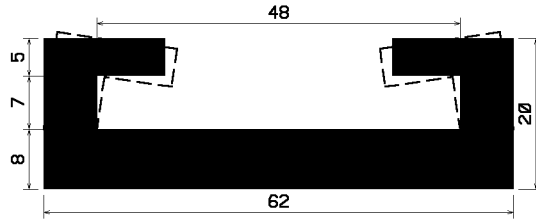

SE2560

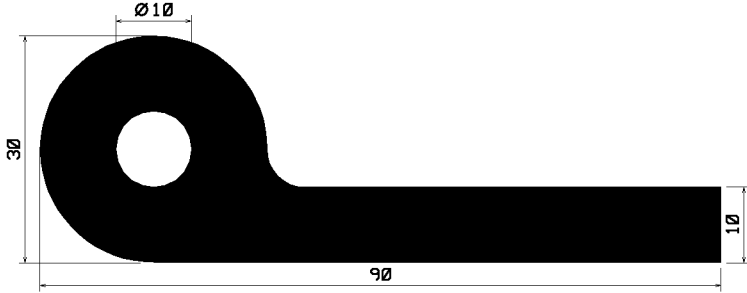

FN2561

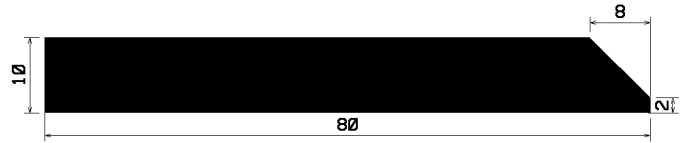

S2562

FT2563
 FT2564
 FT2565
 FT2566

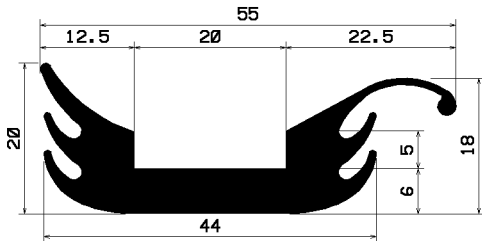

S2567

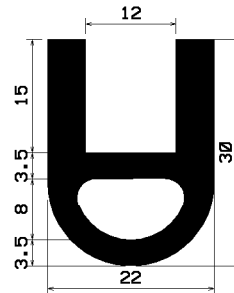

TU1-2568

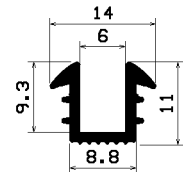

TU1-2569

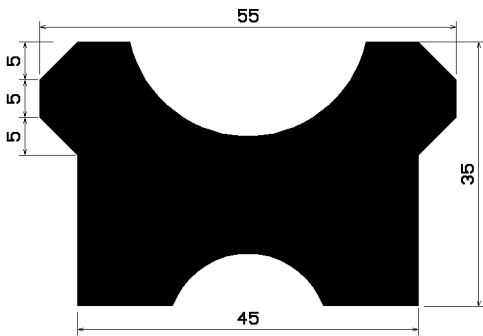

S2570

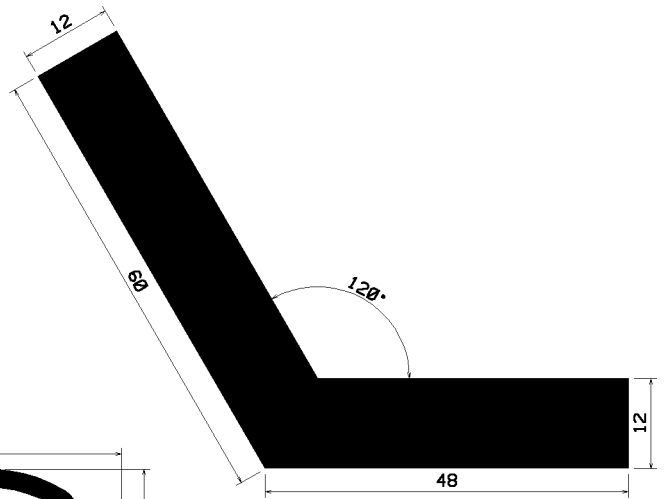

Wi2571

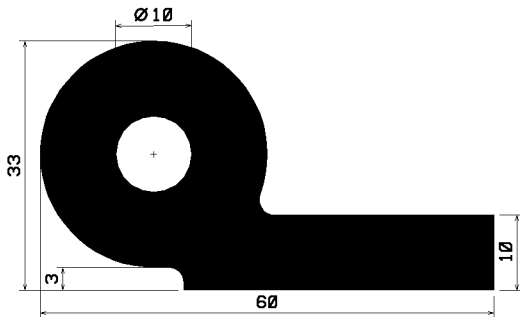

FN2572

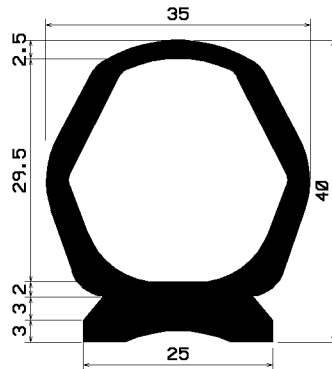

RT2573

FT2574-FT2576

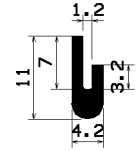
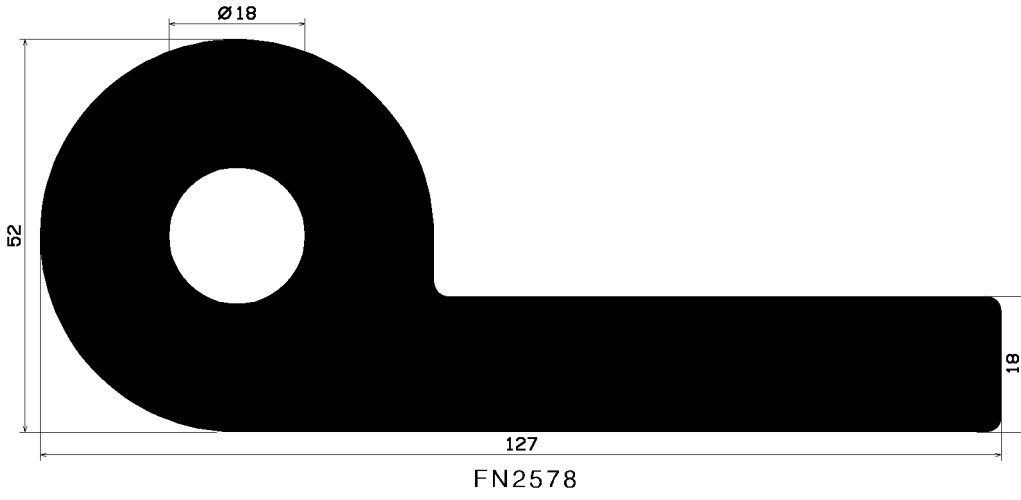

FT2579

TU1-2580

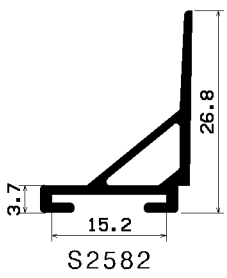

S2582

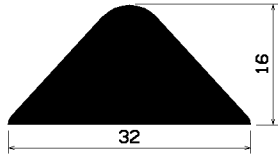

S2583

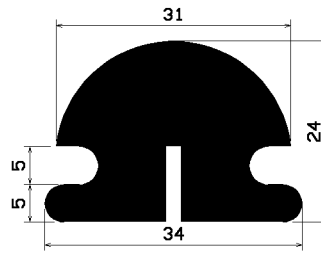

S2584

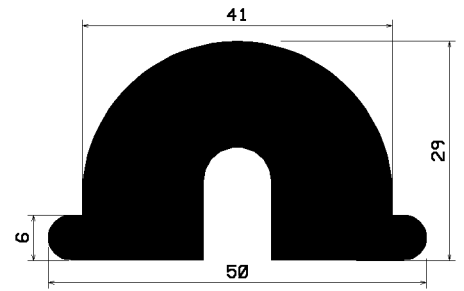

S2585

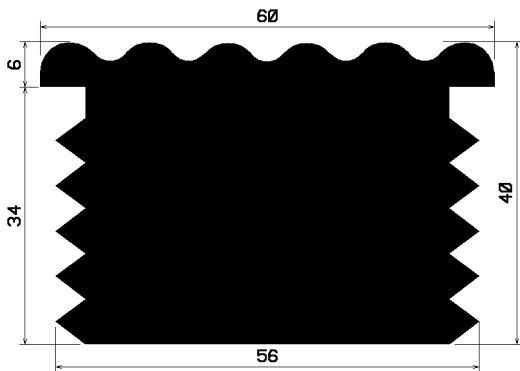

S2586

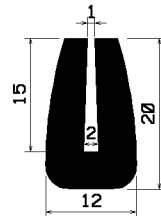

TU1-2587

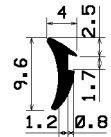

KS2588

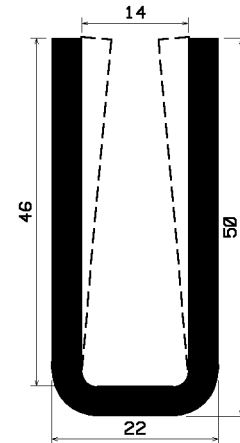

TU1-2589

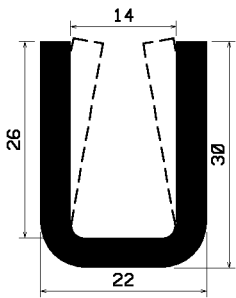

TU1-2590

T2591 S2592-S2598 FT2599

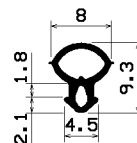

SC2600

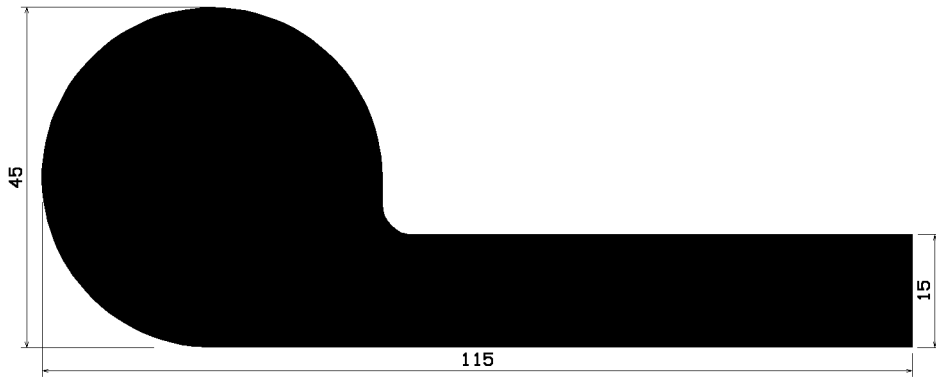

FN2601

FT2602

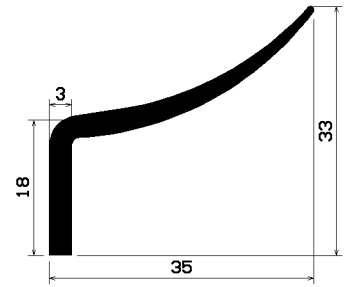

S2603

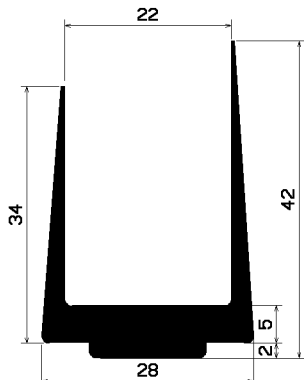

TU1-2604

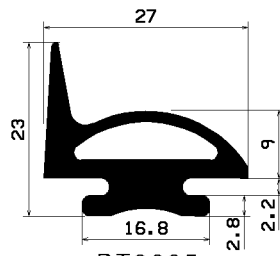

RT2605

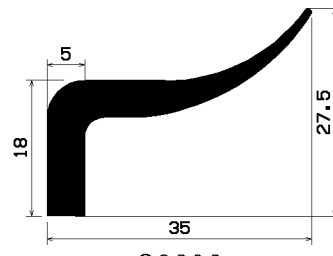

S2606

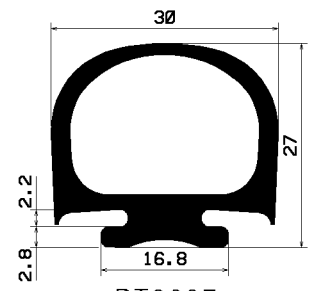

RT2607

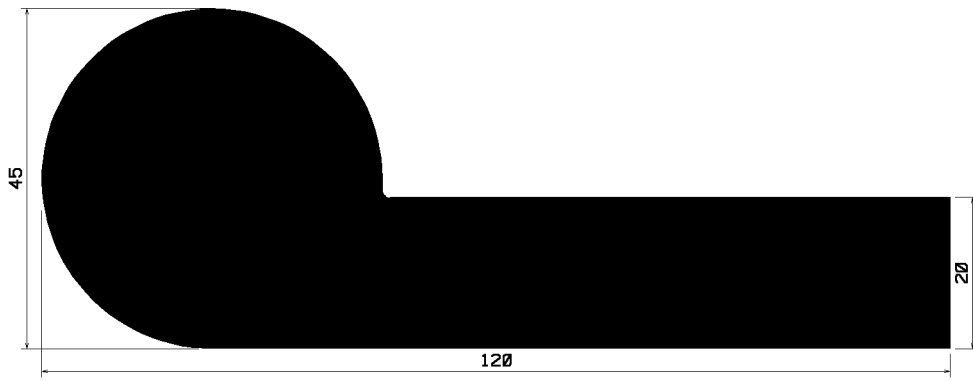

FN2608

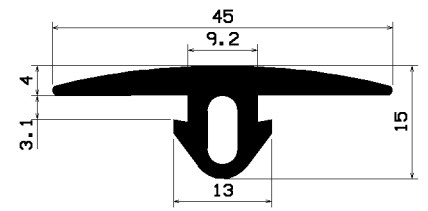

FA2609

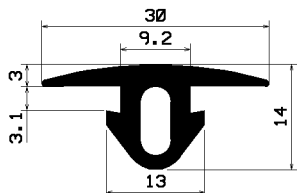

FA2610

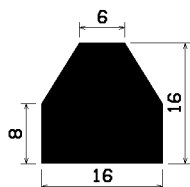

S2611

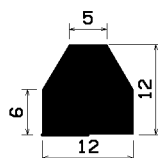

S2612

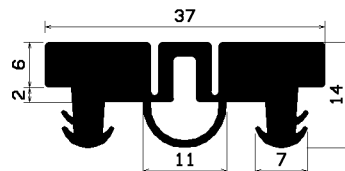

S2613

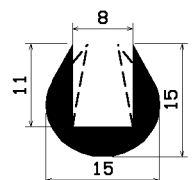

TU1-2614

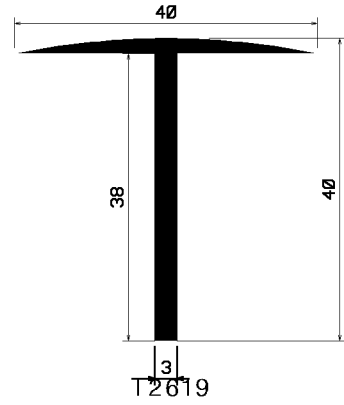
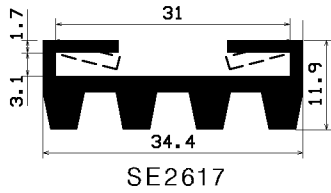
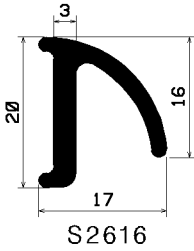
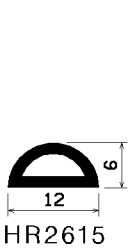

FT2620

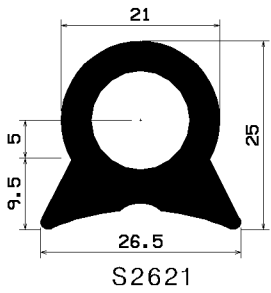
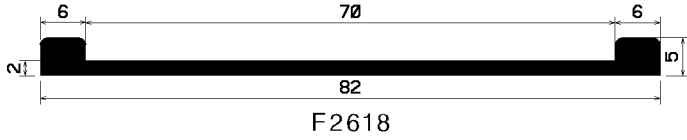

FT2622

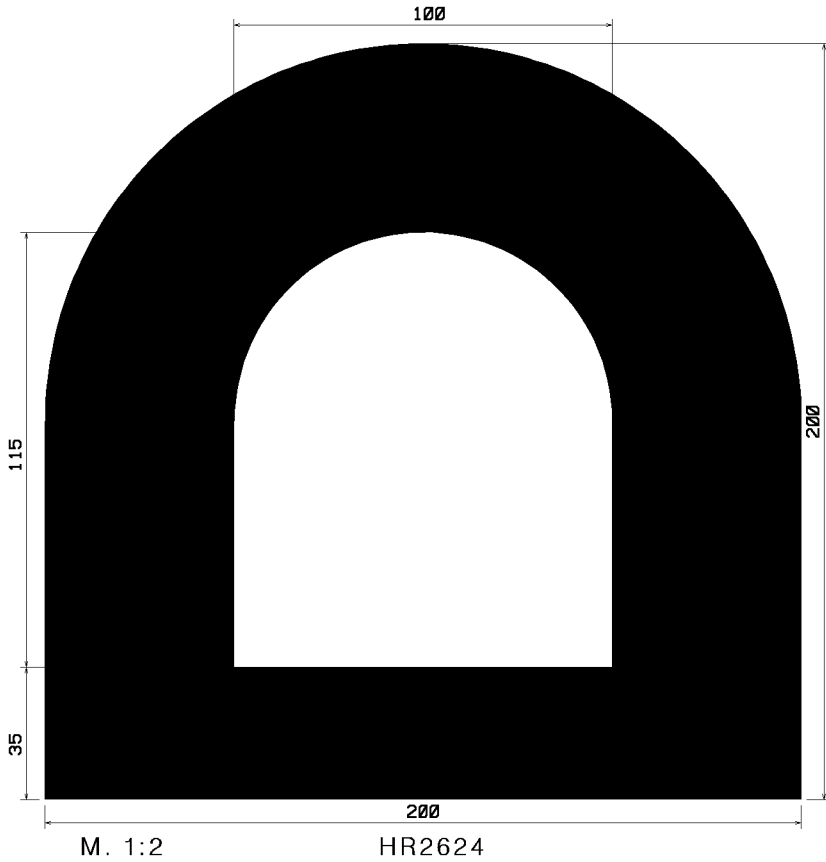
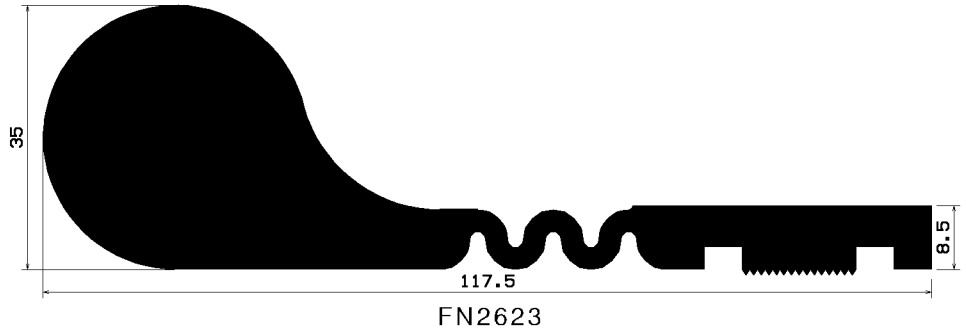

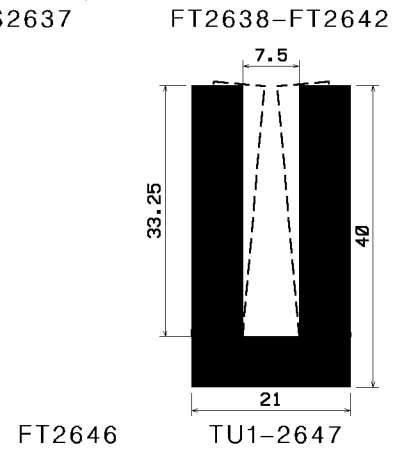
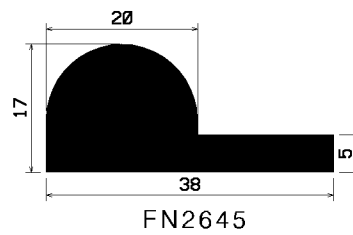
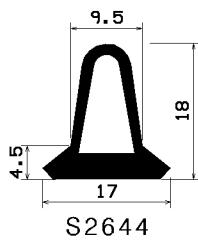
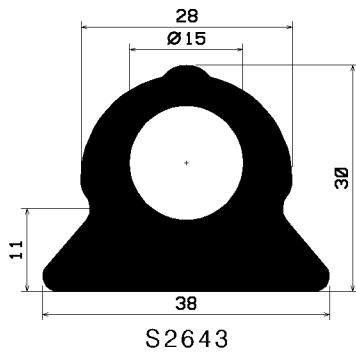
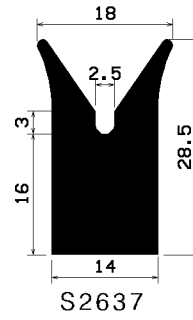
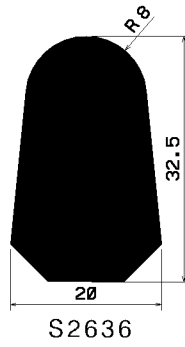
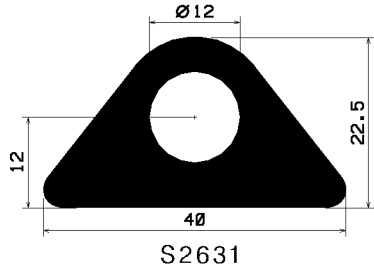
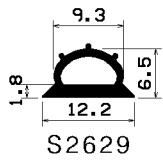
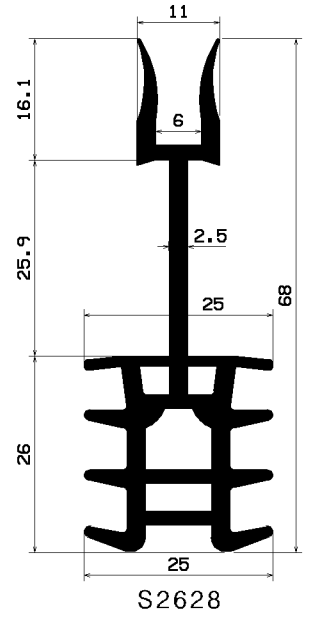
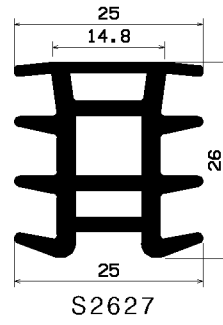
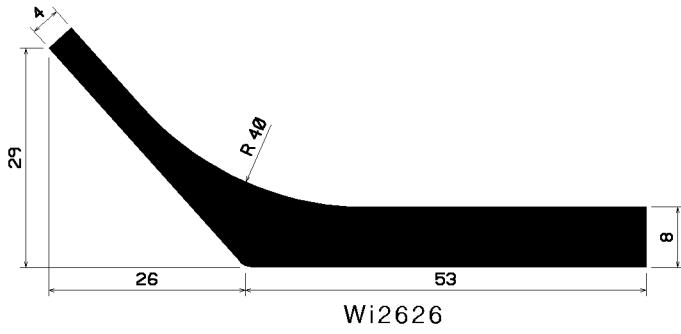
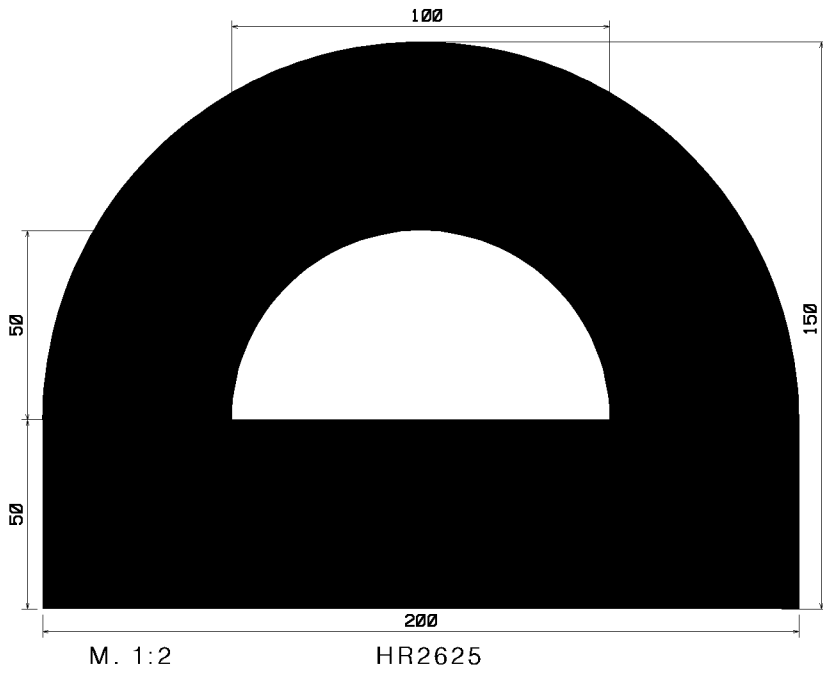

FT2646

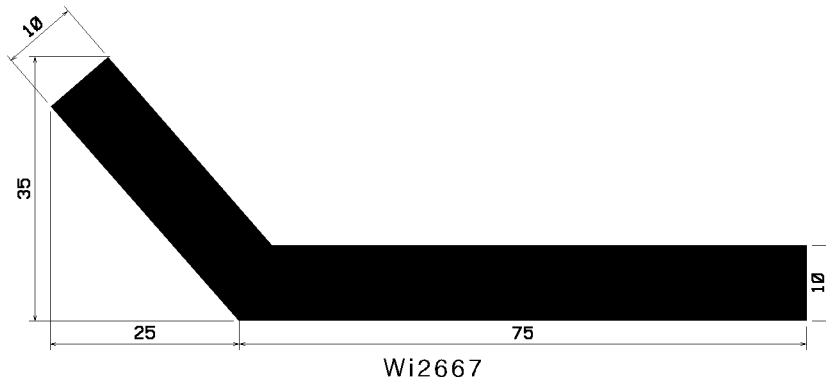
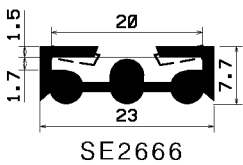
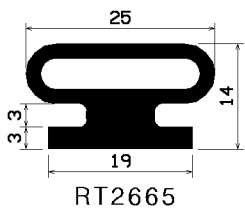
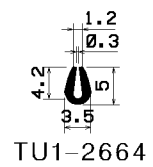
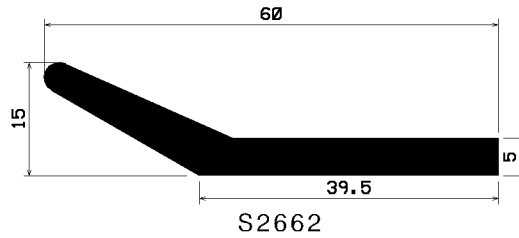
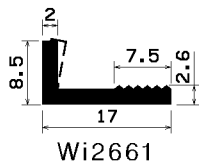
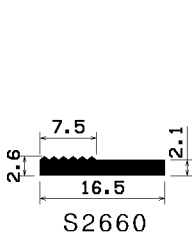
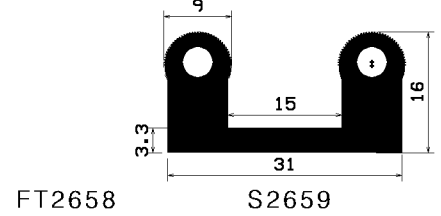
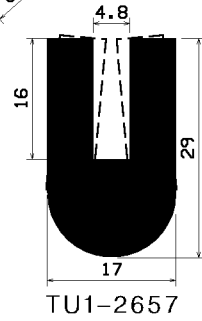
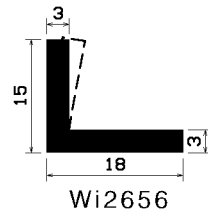
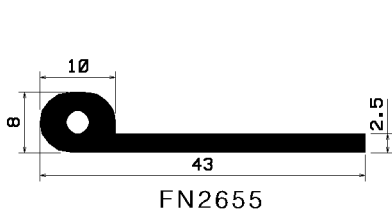
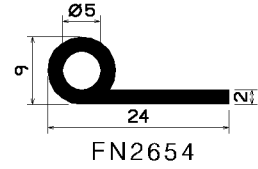
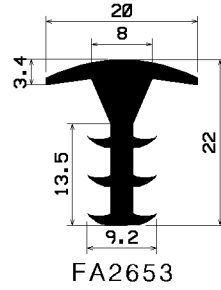
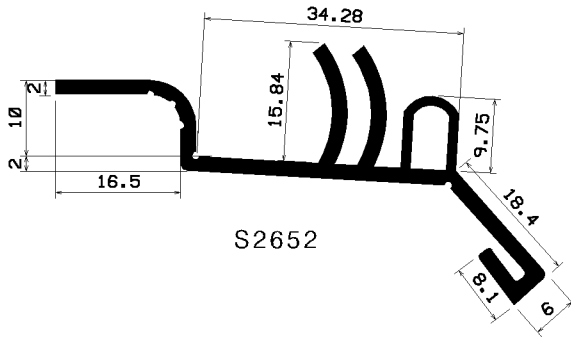
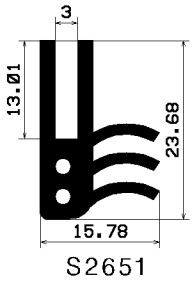
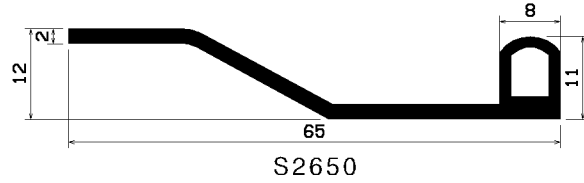
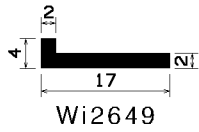
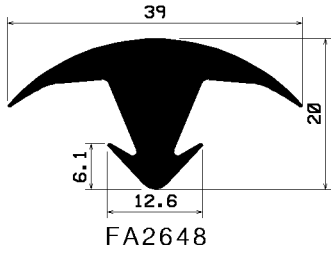

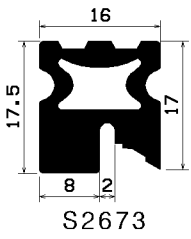
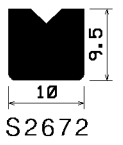
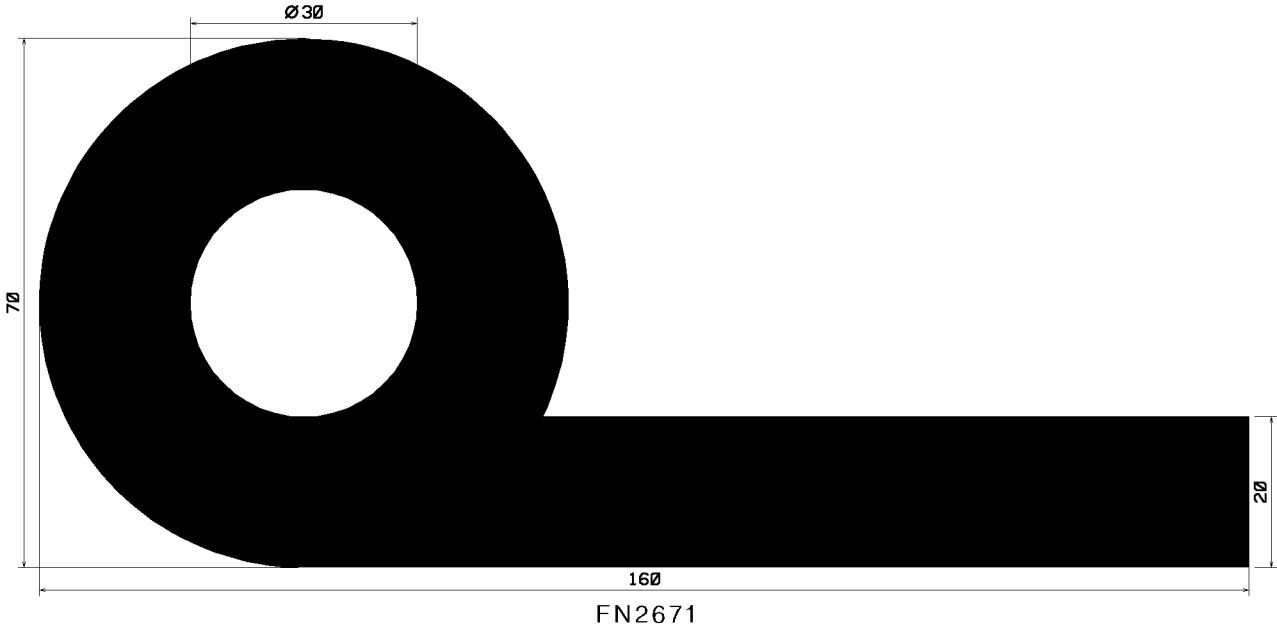
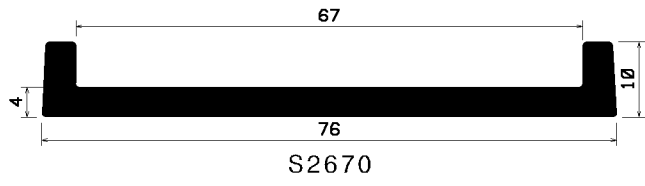
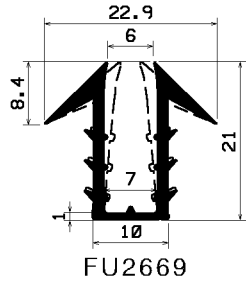
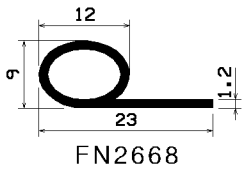

FT2674

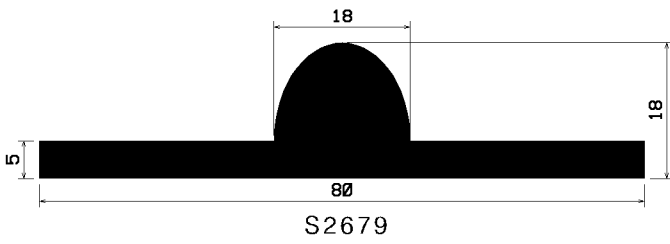
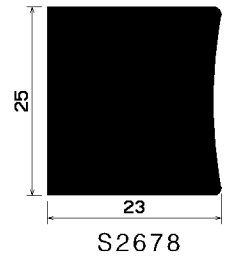
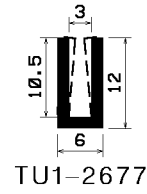
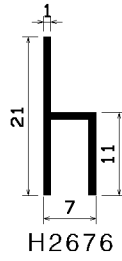
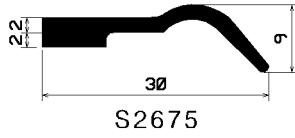

FT2680

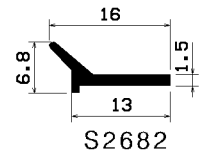
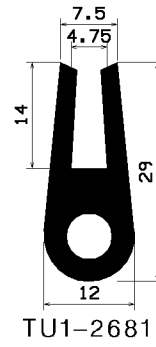

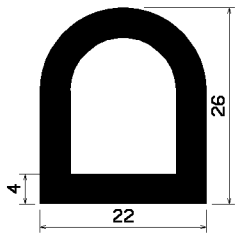

FN2683

HR2684

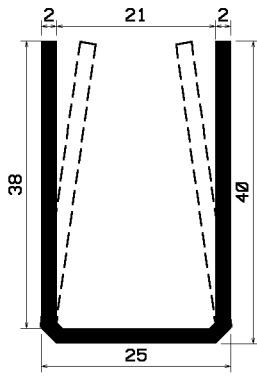

TU1-2685

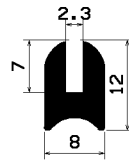

TU1-2686

FT2687

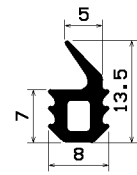

Z1-2688

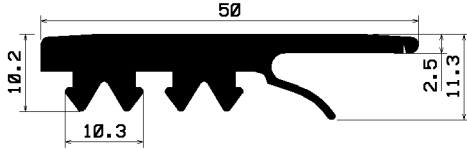

S2689

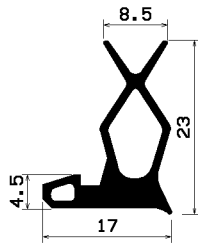

S2690

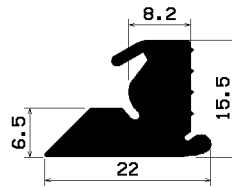

S2691

FT2692

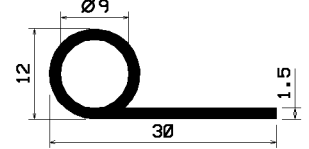

FN2693

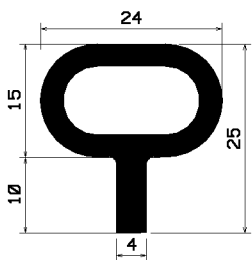

SC2694

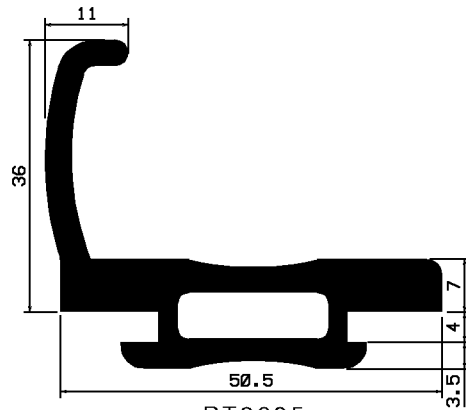

RT2695

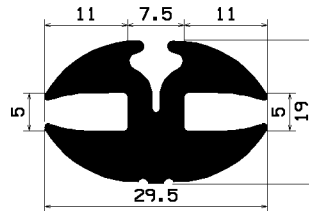

KL2696

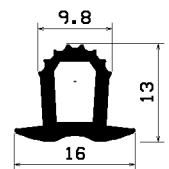

S2697

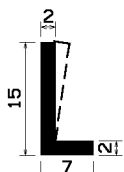

W12698

FT2699

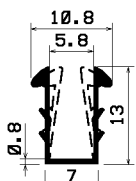

TU1-2701

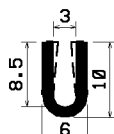

TU1-2702

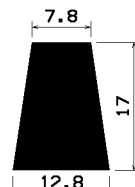

TR2703

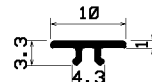

S2704

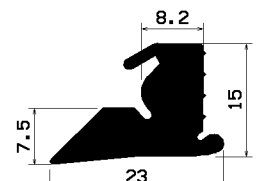

S2705